



SPX532 Quickstart Guide

<i>REVISION</i>		1	
<i>ISSUED BY</i>	ENRICO P.	<i>DATE OF RELEASE</i>	13/03/2020
<i>REVISIONED BY</i>	IGOR P.	<i>DATE OF REVISION</i>	13/03/2020

<i>APPLIED TO MODELS</i>	SPD-SERIES	<input type="checkbox"/> SPD265	<input type="checkbox"/> SPD360	<input type="checkbox"/> SPD500	<input type="checkbox"/>	<input type="checkbox"/>
	JF-SERIES	<input type="checkbox"/> JF30	<input type="checkbox"/> JF40	<input type="checkbox"/> JF365	<input type="checkbox"/> JF545	<input type="checkbox"/> JF990
	SPX-JUNIOR	<input type="checkbox"/> SPB209	<input type="checkbox"/> SPX312	<input type="checkbox"/> SPX424	<input type="checkbox"/> SPX429	<input type="checkbox"/>
	SPX-SENIOR	<input type="checkbox"/> SPX527	<input type="checkbox"/> SPX536	<input type="checkbox"/> SPX1040	<input type="checkbox"/> SPX1275	<input type="checkbox"/>
	MPK-SERIES	<input type="checkbox"/> MPK20	<input type="checkbox"/> MPK50	<input type="checkbox"/>	<input type="checkbox"/>	<input type="checkbox"/>
	NEW SERIE	<input checked="" type="checkbox"/> SPX532	<input type="checkbox"/> SPX1280	<input type="checkbox"/>	<input type="checkbox"/>	<input type="checkbox"/>
	OTHERS	<input type="checkbox"/> SPK 60	<input type="checkbox"/> OTHER	<input type="checkbox"/> TOOLS	<input type="checkbox"/> INSTRUMENT	<input type="checkbox"/>



INDEX

1.	TURN ON THE POWER	3
2.	RELEASE THE EMERGENCY BUTTON	4
3.	POWER UNIT SELECTION.....	5
4.	TURN ON THE REMOTE CONTROL	6
5.	START/STOP DIESEL ENGINE (OR POWER PACK).....	7
6.	CONFIRM LMI CONFIGURATION	8
7.	MODIFY LMI CONFIGURATION.....	9
8.	WORKING MODE SELECTION	11
9.	TRACKS	13
10.	OUTRIGGERS UP & DOWN	16
11.	CRANE.....	23
12.	PICK & CARRY.....	26
13.	MACHINE STABILITY (NO FUNCTIONS AVAILABLE)	30
14.	ENGINE POWER MODE SELECTOR	32
15.	WINCH SPEED REDUCTION SELECTOR	33
16.	CRANE SPEED REDUCTION SELECTOR.....	34
17.	ALARMS & WARNINGS	35

1. TURN ON THE POWER

Go to the right side of the machine's central frame, where the main switch is placed.

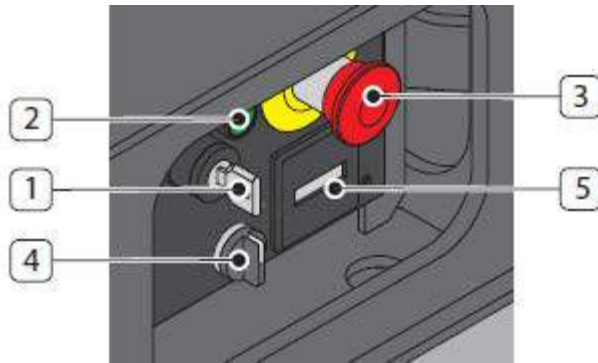
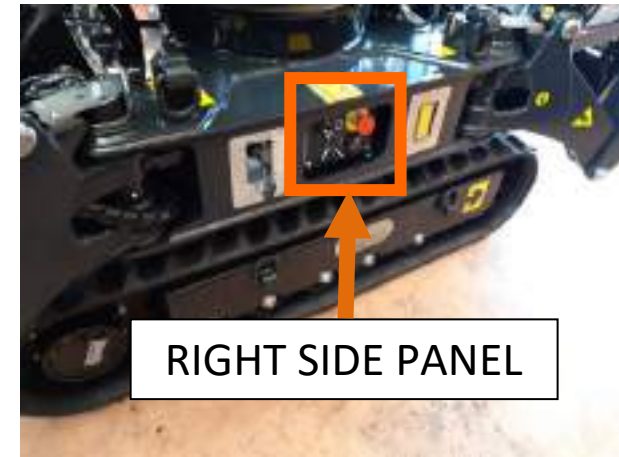

On the right side panel there are the following devices:

- *main power switch (1);*
- *main power led indicator (2);*
- *emergency button (3);*
- *power unit switch selector (4);*
- *hour counter (5).*

Turn on the **Main power switch** to energize the machine (the *Main power led indicator* will turn on).



2. RELEASE THE EMERGENCY BUTTON

Check and release the emergency button on the right side panel of the machine.



Check and release the emergency button on the remote control.



3. POWER UNIT SELECTION

By rotating the **Power unit switch selector** (located on right side panel) it will be possible to engage the desired power unit:

LITHIUM BATTERY PACK

POWER PACK *

DIESEL ENGINE

POWER PACK *



SPX532CL version



SPX532CDH version

*if power pack is present.

4. TURN ON THE REMOTE CONTROL



Turn on the **remote control key**.

Press once the **Start button** on the left side of the remote control and wait for “Loading HMI ...” (about 5 sec.)

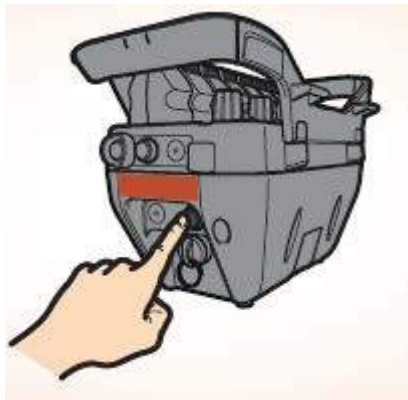

When requested on the screen, press again the **Start button** and wait for “Configuring Radio”.

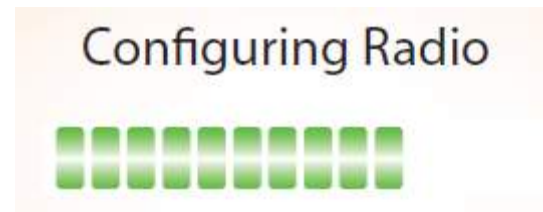

5. START/STOP DIESEL ENGINE (OR POWER PACK)

To start the diesel engine on SPX532CDH version (or the power pack electric motor), use the **Engine start/stop selector** on the remote control:



↑
START DIESEL ENGINE / POWER PACK

↓
**TURN OFF DIESEL ENGINE / POWER PACK
OR PRE-HEAT THE PLUGS (IF DIESEL ENGINE IS SELECTED AND IS OFF)**

NOTE FOR SPX532CL MODEL ONLY:

The lithium battery pack power unit doesn't need to be started/stopped using the *Engine selector*: as soon as one or more functions are operated from the remote control, the electric motor is activated and the pump starts/stops running automatically.

6. CONFIRM LMI CONFIGURATION

The LMI configuration page will be displayed automatically (see the picture beside).



Press the  button (on top of the screen to the right) to confirm the LMI configuration.

IMPORTANT:

Always check the congruity between the LMI configuration on the display and the real configuration of the machine!

Once the LMI settings are confirmed, the **LMI icon** on top of the screen will become green:



LMI CONFIGURATION CONFIRMED



LMI CONFIGURATION NOT CONFIRMED



7. MODIFY LMI CONFIGURATION

Only if needed, use the **Line falls selector** to modify the LMI configuration and set the correct number of rope lines/falls or the hook mode:



INCREASE THE ROPE LINE FALLS NUMBER





PRESS ONCE TO GO BACK TO HOOK MODE IMMEDIATELY

NOTE:



The machine recognizes automatically the tool installed, thanks to the Plug&Play feature.
The operator is responsible to properly set the rope line falls or hook mode.

7.1. LMI possible configurations

MAIN BOOM:

-  Hook mode
-  1 line
-  2 lines
-  3 lines
-  4 lines

JIB1000.2HL1MX:

-  Hook mode
-  1 line

7.2. SELECTION JIB ON BOARD

From *LMI configuration page* it is possible to select **jib on board** by pressing **Button 3**.

Jib on board icon legend



JIB PARKED ON BOARD: the LMI takes in count the weight of the jib parked on the boom



JIB NOT ON BOARD: the LMI doesn't take in count the weight of the jib

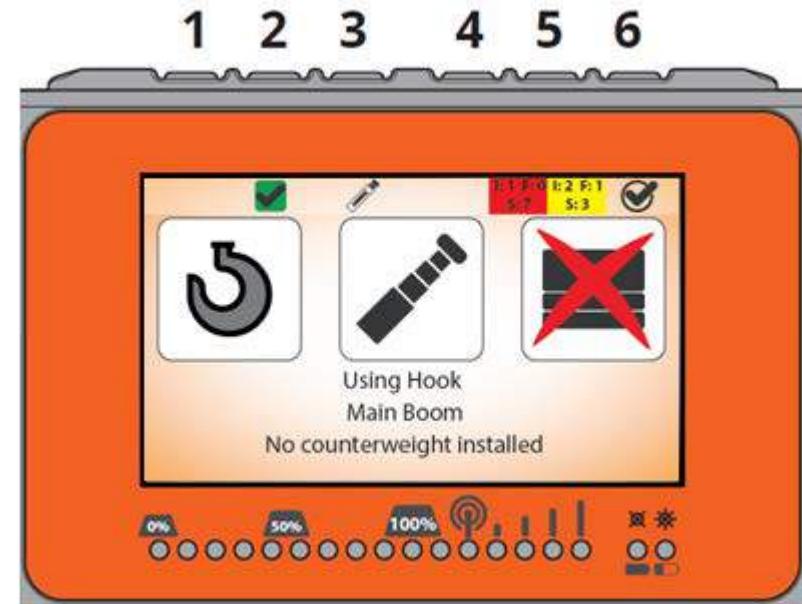

NOTE:

On SPX532 the counterweight is not removable!

8. WORKING MODE SELECTION

Turn the **Working mode selector** to select the desired working mode:



Pick & Carry   **PAY ATTENTION! TURRET ROTATION ENABLED!**



Tracks



Crane



Outriggers Up & Down

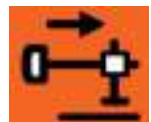

Machine stability (no functions available)

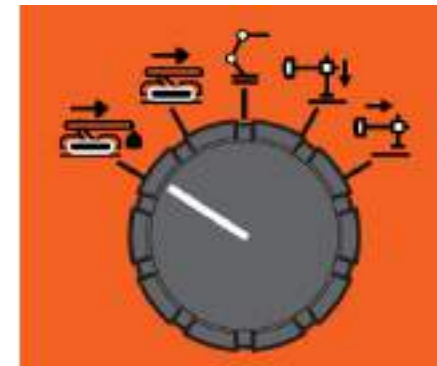

IMPORTANT:

BY ROTATING THE WORKING MODE SELECTOR THE MACHINE'S FUNCTIONS WILL BE DISABLED!

Each time that the working mode changes by rotating the selector, the functions must be enabled again **BY PRESSING THE START BUTTON ON THE REMOTE CONTROL!**

8.1. HOW TO SCROLL WORKING MODE'S PAGES

IMPORTANT:

AVOID TO ROTATE THE **WORKING MODE ROTARY SWITCH** TO VISUALIZE THE WORKING PAGES!
YOU WILL **DISABLE THE MACHINE FUNCTIONS** AND IF THE CONDITIONS TO ENABLE THE WORKING MODE AGAIN ARE NOT SATISFIED, **THIS CAN LEAD TO A LOCKED SITUATION!**

It's warmly suggested to scroll the working pages by pressing the **Arrows buttons** on top of the screen, so the machine remains enabled and the working mode doesn't change.

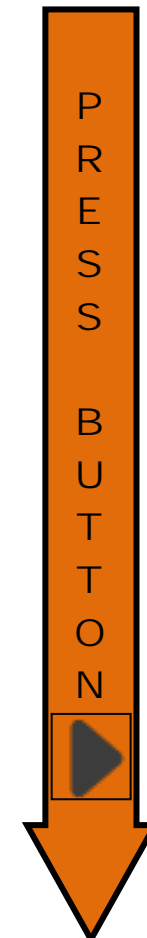
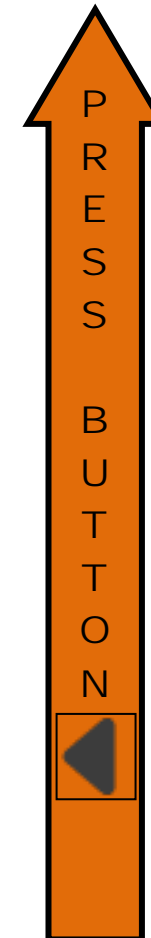
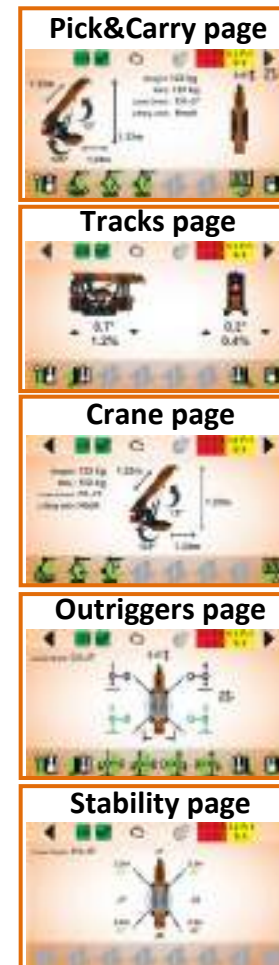
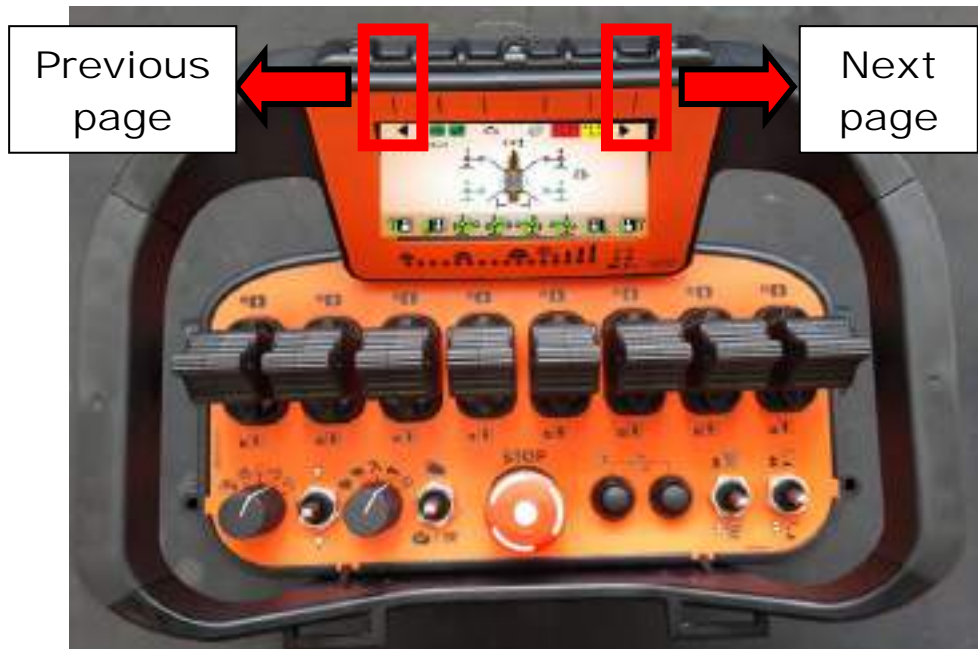

9. TRACKS

Rotate the *Working mode selector* in position  and the Tracks page will be displayed on the screen (see the picture beside).

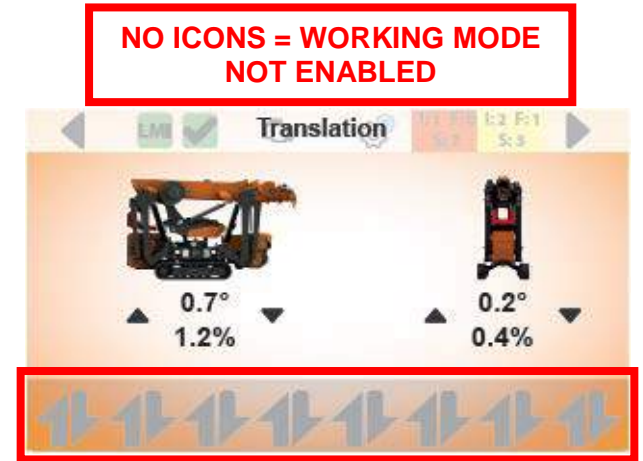
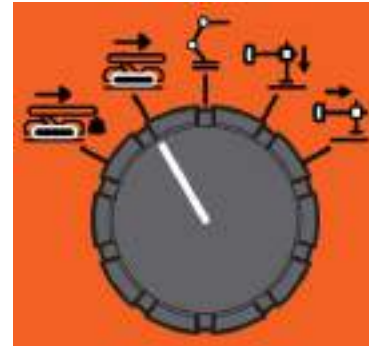

IMPORTANT:

If the icons of the levers are not displayed on bottom of the screen, the working mode needs to be enabled!



9.1. ENABLE TRACKS FUNCTIONS

To enable the translation functions press once the **Start button** on the remote control. The conditions to enable tracks functions are in the next page. Once the functions are enabled, the **Machine enabled icon** (on top of the screen) will become green and the icons of the levers will appear (on the bottom of the screen).

-  **MACHINE WORKING MODE ENABLED**
-  **MACHINE WORKING MODE NOT ENABLED**

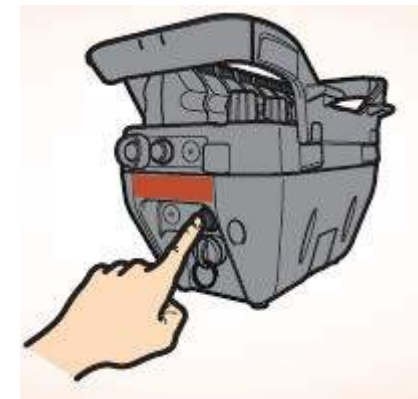

9.2. CONDITIONS TO ENABLE TRACKS

The following conditions must be respected to enable the tracks functions:

- All 4 outriggers lifted from the ground;
- Crane must be in parking position (0° or $180^\circ \pm 3^\circ$);
- Main boom telescopic FULLY RETRACTED;
- Main boom angle $\leq 45^\circ$;
- NO LOAD on tip of the boom;
- If hydraulic jib is installed, it must be fully retracted.

If these conditions are not respected, the icons of the levers won't appear on bottom of the screen and it won't be possible to operate the functions.

9.3. TRACKS SCREEN APPEARANCE



9.4. TRACKS FUNCTIONS

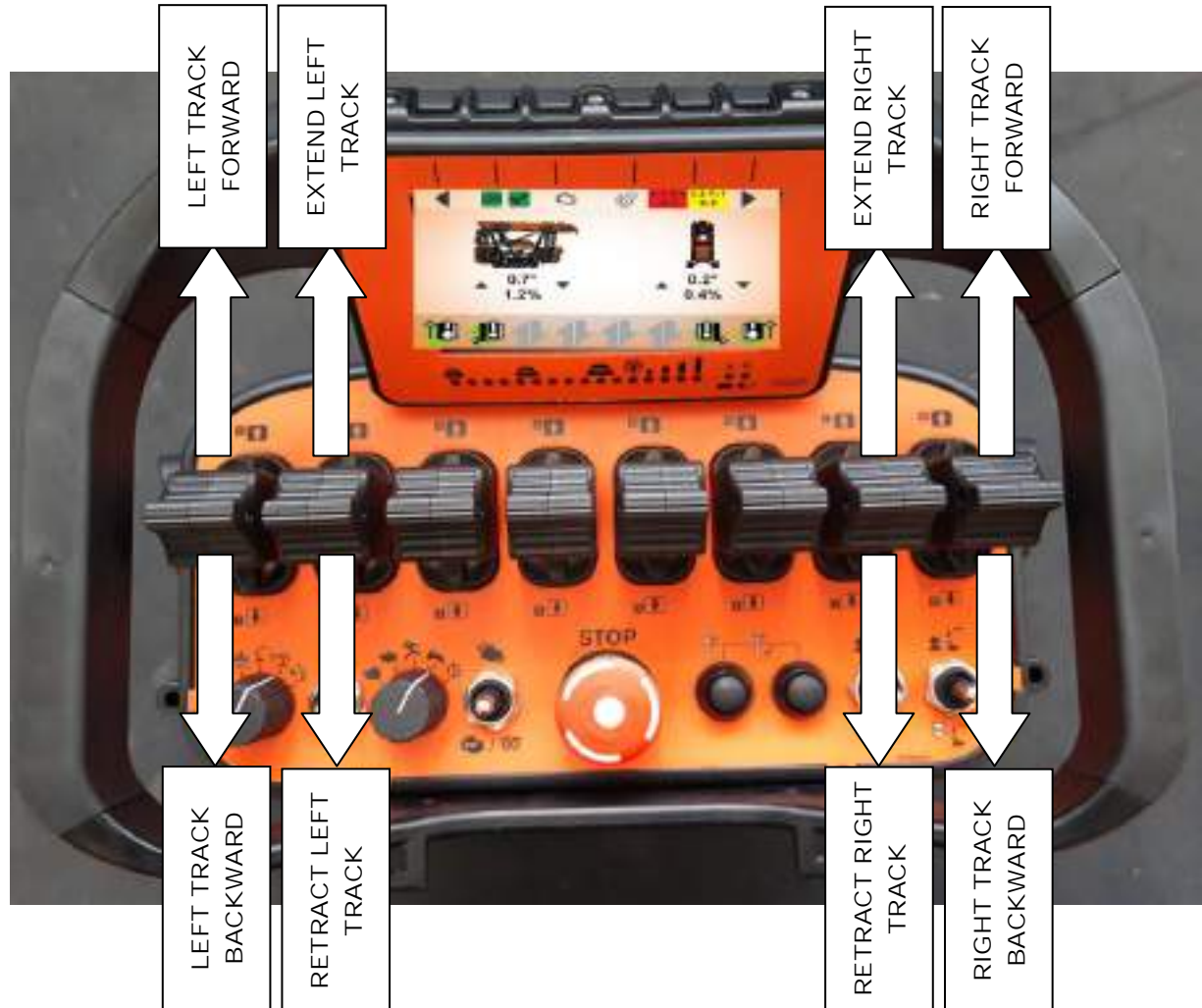

10. OUTRIGGERS UP & DOWN

Rotate the *Working mode selector* in position  and the Outriggers page will be displayed (see picture beside).

IMPORTANT:

If the icons of the levers are not displayed on bottom of the screen, the working mode needs to be enabled!

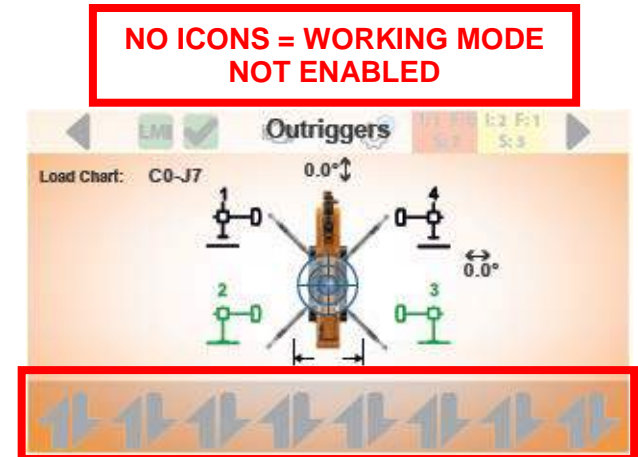
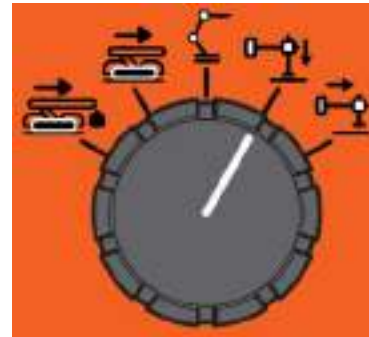

10.1. ENABLE OUTRIGGERS FUNCTIONS

To enable the outriggers functions press once the **Start button** on the remote control.

The conditions to enable outriggers up & down functions are in the next page.

Once the functions are enabled, the **Machine enabled icon** (on top of the screen) will become green and the icons of the levers will appear (on the bottom of the screen).



MACHINE WORKING MODE ENABLED



MACHINE WORKING MODE NOT ENABLED

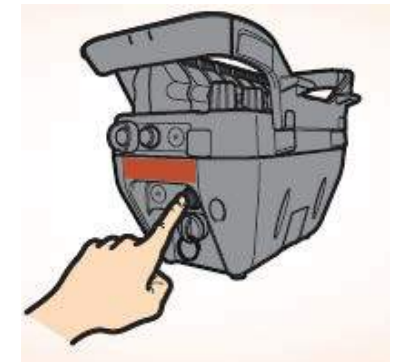

10.2. CONDITIONS TO ENABLE OUTRIGGERS UP & DOWN

The following conditions must be respected to enable the outriggers up & down functions:

- Crane must be in parking position (0° or $180^\circ \pm 3^\circ$);
- Main boom telescopic FULLY RETRACTED;
- Main boom angle $\leq 45^\circ$;
- NO LOAD on tip of the boom;
- If hydraulic jib is installed, it must be fully retracted.

If these conditions are not respected, the icons of the levers won't appear on bottom of the screen and it won't be possible to operate the functions.

10.3. OUTRIGGERS UP & DOWN SCREEN APPERANCE

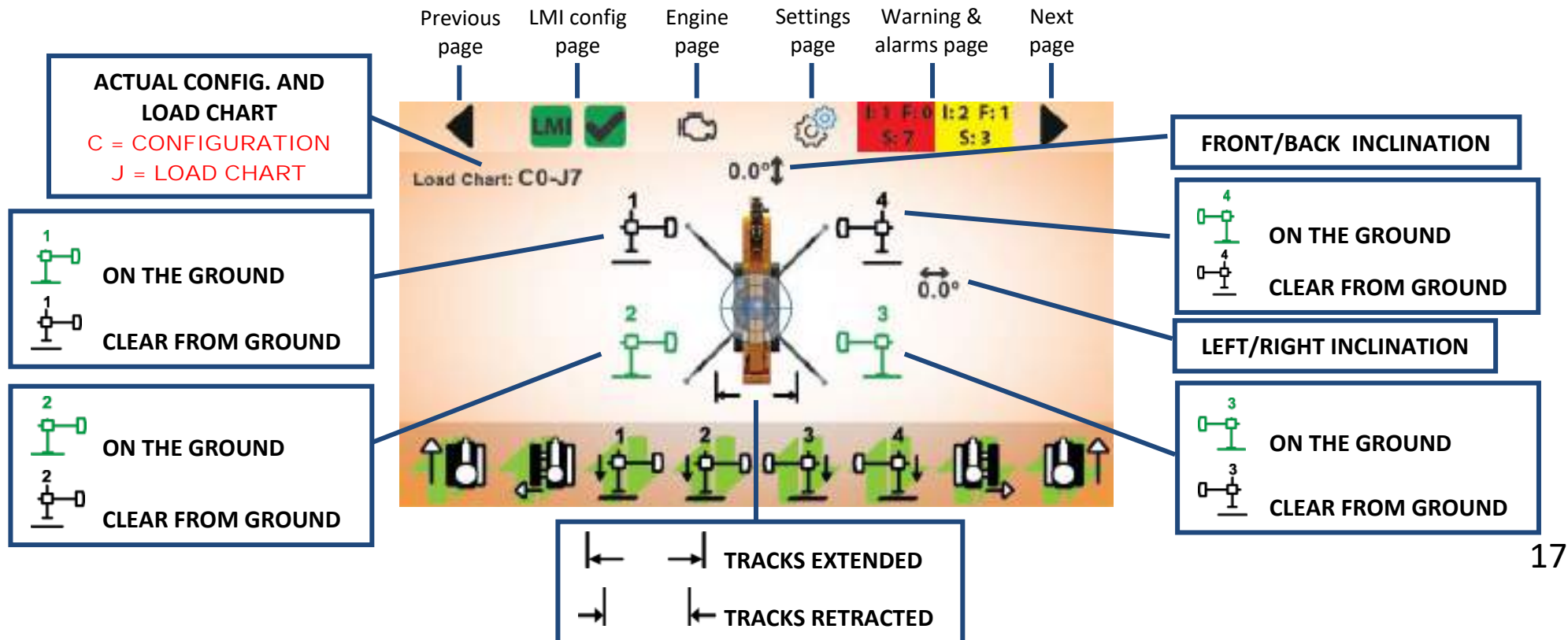

10.4. OUTRIGGERS UP & DOWN FUNCTIONS

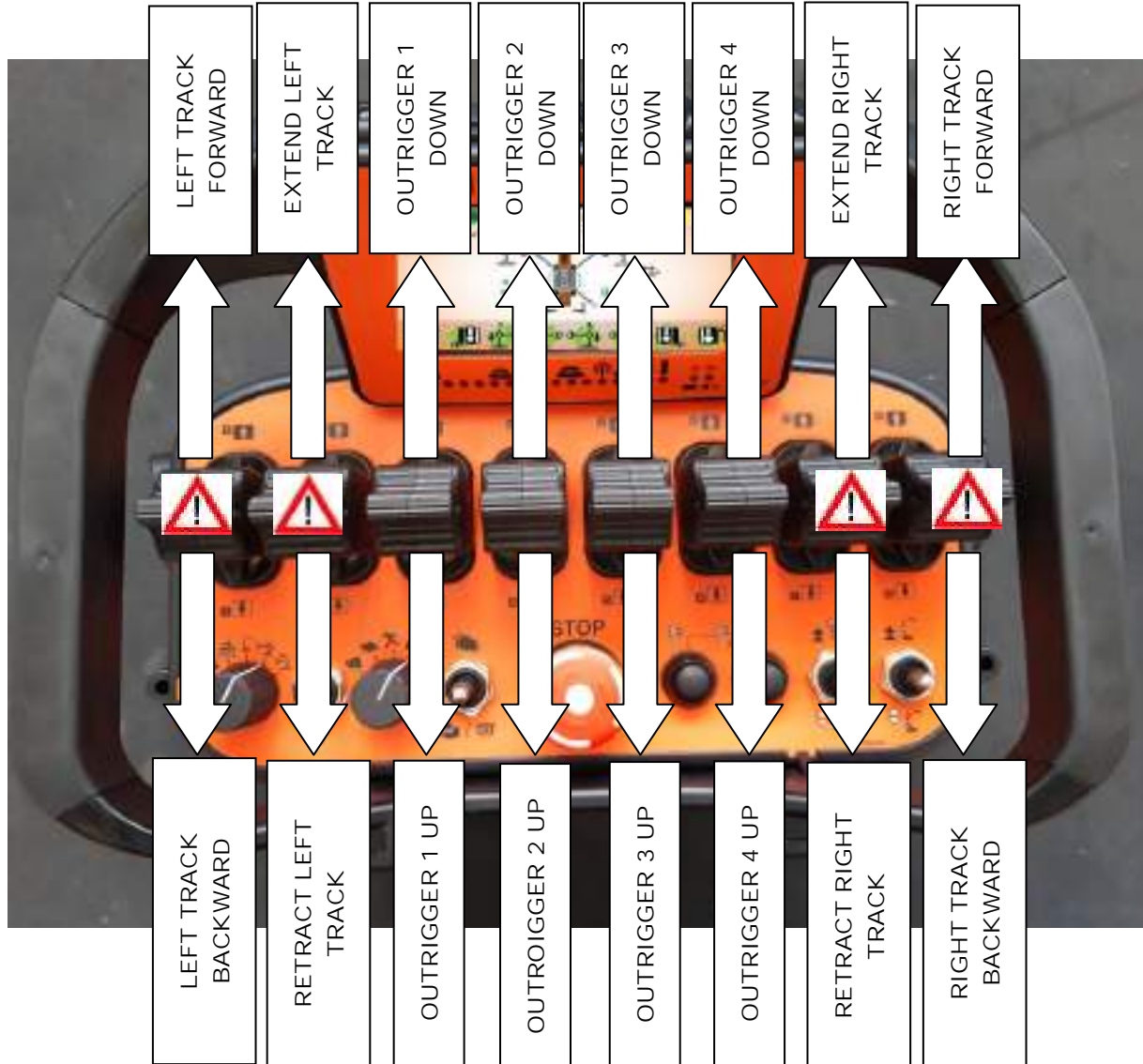

WARNING!

The tracks drive and tracks extension are always enabled when the outriggers mode is enabled!

10.5. OUTRIGGERS OPENING ANGLES (SWING FUNCTION)

Possible outriggers opening angles: 0° - 20° - 47° - 68° - 90°.



All outriggers at 0°



All outriggers at 20°



All outriggers at 47°



All outriggers at 68°



All outriggers at 90°

The machine can work with differentiated areas and in many different outriggers configurations.

NOTE:

For further details about the overall dimensions check the Technical data.

10.6. OUTRIGGERS EXTENSION

Possible outriggers extension positions: 2.15m or 2.62m.

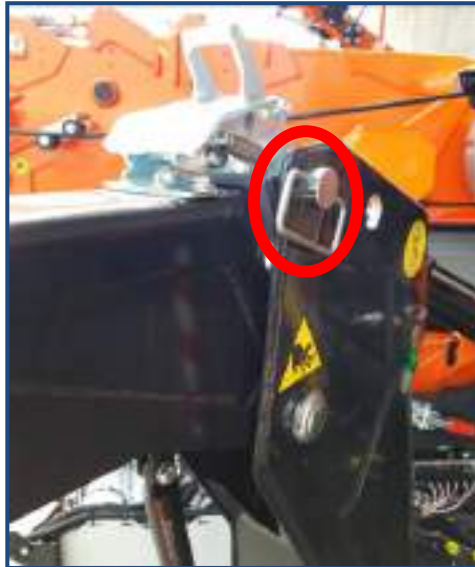

Outrigger retracted

The load charts are calculated according to the outriggers opening angles (swing) and extension.

NOTE:

When the outrigger is in retracted position, the lifting capacity will be de-rated (less stability = less capacity)

Each outrigger has got two sensors:

- on ground position sensor;
- outrigger extension sensor.

The machine can be operated in **differentiated lifting capacity areas** applying different load charts according to the stability conditions.



Outrigger extended

10.7. OUTRIGGERS / TURRET INTERFERENCE

When stabilizing the machine, pay attention to the safety stickers installed on the outriggers' cylinders.

IMPORTANT:

To avoid the interference between outriggers and turret, the green arrow must be into the green area!

Pay attention while performing the turret rotation function!

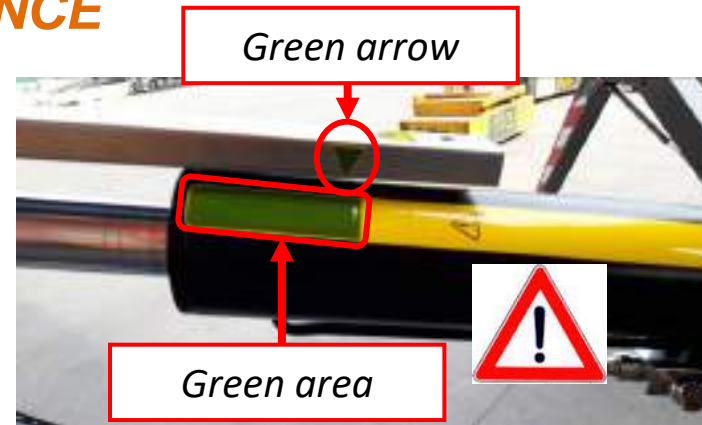

It's operator's responsibility to properly stabilize all 4 outriggers to avoid this interference!



JIB1000.2H interference



Ballast interference

10.8. SELF-LEVELING BUTTON

Thanks to the biaxial planimetric sensor, the SPX532 can be stabilized automatically by holding the **Self-leveling button**.

NOTE:

The self-leveling function will operate only outriggers down maneuvers (LIFTING UP THE MACHINE).

The self-leveling function stops when you release the button or when carrier's inclination is 0° on both axes.

The self-leveling doesn't prevent the outriggers / turret interference (see chapter 9.8)!



10.9. SELF-LEVELING CONDITIONS

Self-leveling function can be operated if:

- outriggers functions are enabled (see chapters 10.1 and 10.2);
- **all 4 outriggers have the same swing angle** (not possible at 0° or 90°).

The self-leveling function is possible even if some outriggers are extended and some outriggers are retracted.



Self-leveling not allowed with all outriggers at 0° or all outriggers at 90°

11. CRANE

Rotate the *Working mode selector* in position  and the Crane page will be displayed (see picture beside).

IMPORTANT:

If the icons of the levers are not displayed on bottom of the screen, the working mode needs to be enabled!

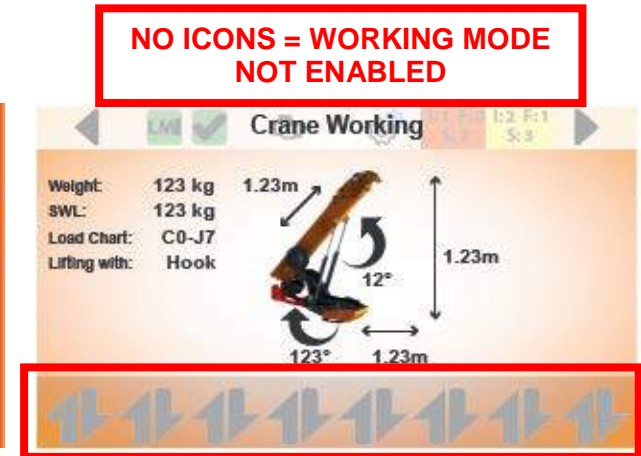
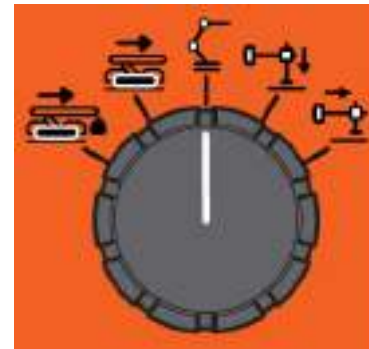

11.1. ENABLE CRANE FUNCTIONS

To enable the crane functions press once the **Start button** on the remote control.

The conditions to enable crane functions are in the next page.

Once the functions are enabled, the **Machine enabled icon** (on top of the screen) will become green and the icons of the levers will appear (on the bottom of the screen).



MACHINE WORKING MODE ENABLED



MACHINE WORKING MODE NOT ENABLED

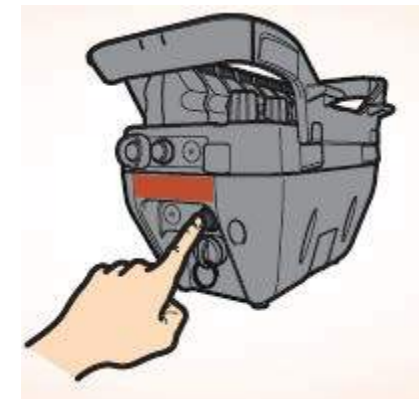

11.2. CONDITIONS TO ENABLE CRANE

The following conditions must be respected to enable the crane functions:

- All 4 outriggers on the ground;
- All 4 outriggers opening angles (swing) must be acceptable values (locking pin correctly inserted).

If these conditions are not respected, the icons of the levers won't appear on the display and it won't be possible to operate the functions

11.3. CRANE SCREEN APPERANCE

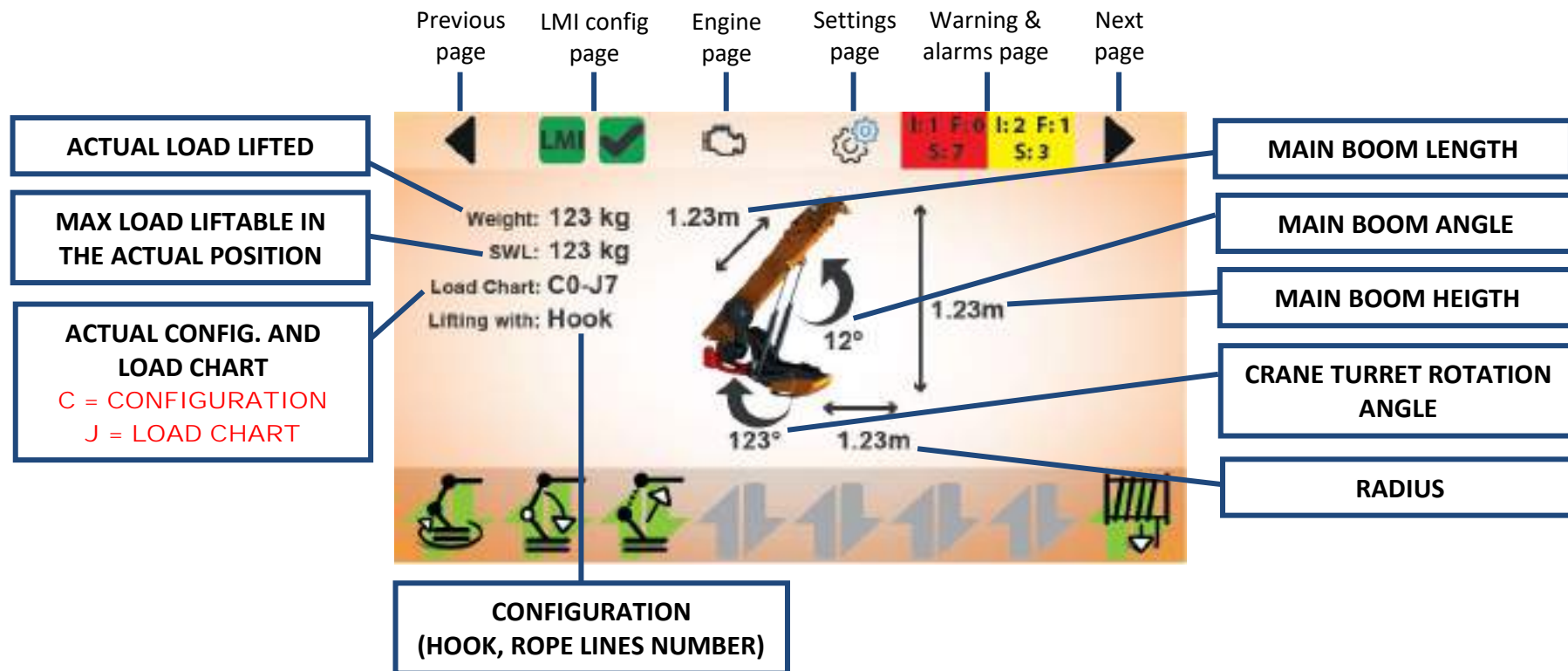

11.4. CRANE FUNCTIONS

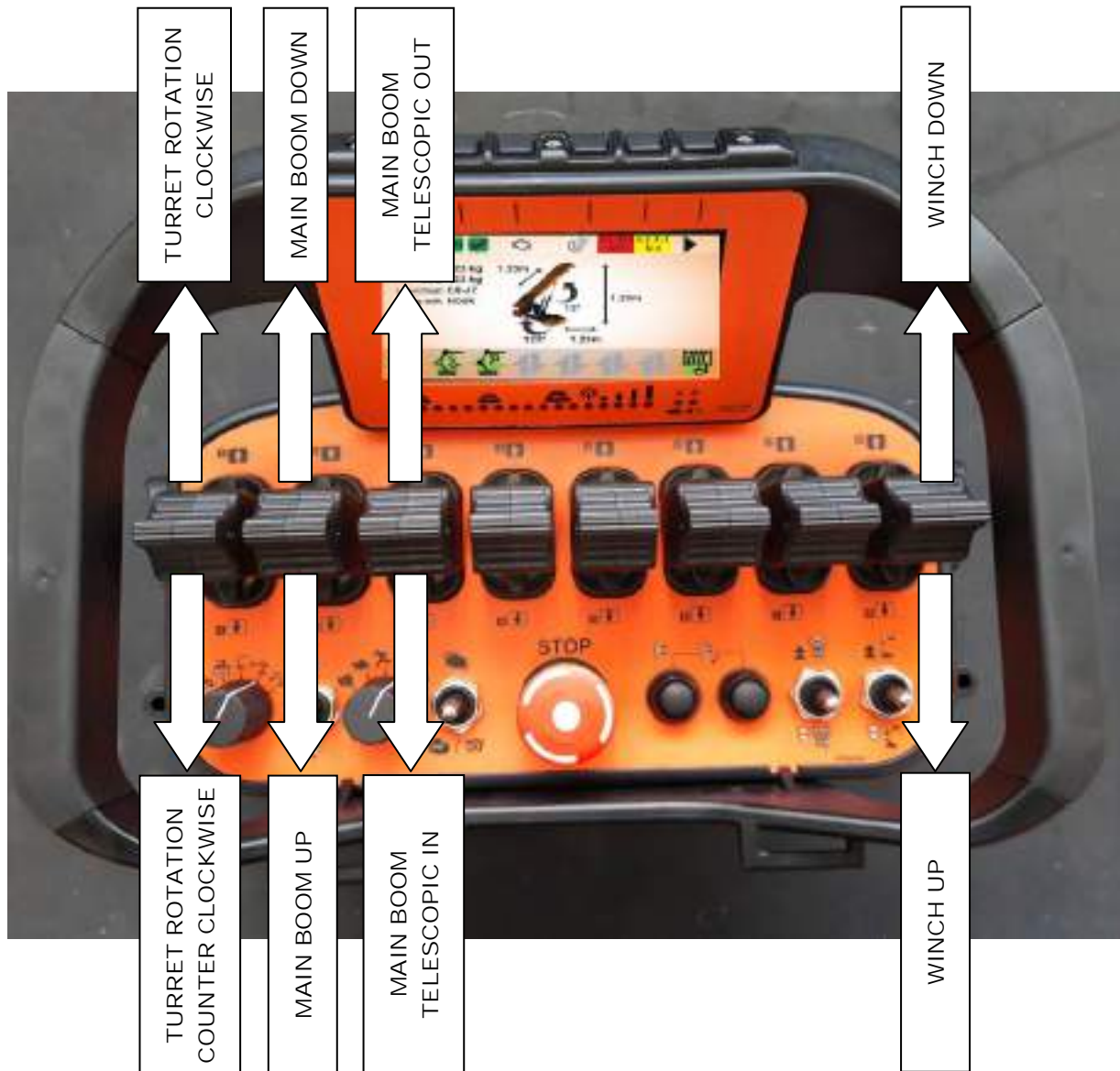

WARNING!

The winch functions are automatically disabled when working in hook mode!

12. PICK & CARRY



PAY ATTENTION! TURRET ROTATION ENABLED!

Rotate the *Working mode selector* in position  and the Pick & Carry page will be displayed (see picture beside).

IMPORTANT:

If the icons of the levers are not displayed on bottom of the screen, the working mode needs to be enabled!

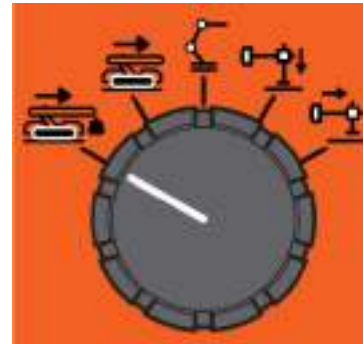

12.1. ENABLE PICK & CARRY FUNCTIONS

To enable the pick&carry functions press once the **Start button** on the remote control.

Once the functions are enabled, the **Machine enabled icon** (on top of the screen) will become green and the icons of the levers will appear (on the bottom of the screen).



MACHINE WORKING MODE ENABLED



MACHINE WORKING MODE NOT ENABLED

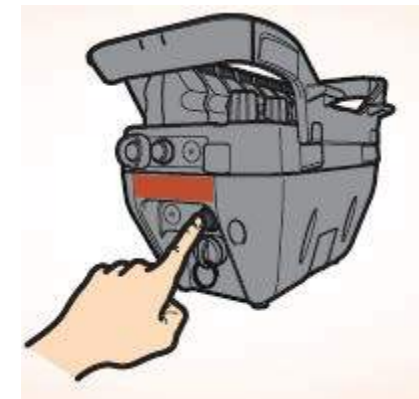



12.2. CONDITIONS TO ENABLE PICK & CARRY

The following conditions must be respected to enable the pick & carry functions:

- All 4 outriggers lifted up from the ground
- No load (only at the moment of enabling).

If these conditions are not respected, the icons of the levers won't appear on the display and it won't be possible to operate the functions.

12.3. PICK & CARRY SCREEN APPEARANCE

The screenshot shows the LMI (Load Moment Indicator) screen with the following elements:

- Navigation:** LMI config page, Engine page, Settings page, Warning & alarms page, Next page.
- Top Status:** LMI (checked), Engine icon, Settings gear, Warning & alarms (I:1 F:0 S:7, I:2 F:1 S:3), Next page arrow.
- Main Display:**
 - Weight: 123 kg
 - SWL: 123 kg
 - Load Chart: C0-J7
 - Lifting with: Hook
- Left Callouts:**
 - MAIN BOOM LENGTH: 1.23m
 - MAIN BOOM ANGLE: 12°
 - MAIN BOOM HEIGHT: 1.23m
 - RADIUS: 1.23m
 - CRANE TURRET ROTATION ANGLE: 123°
- Right Callouts:**
 - LEFT/RIGHT INCLINATION: 0.0°
 - FRONT/BACK INCLINATION: 0.0°
 - ACTUAL LOAD LIFTED: 0.0t
 - MAX LOAD LIFTABLE IN THE ACTUAL POSITION: 0.0t
 - ACTUAL CONFIG. AND LOAD CHART: C = CONFIGURATION, J = LOAD CHART
- Bottom Callouts:**
 - CONFIGURATION (HOOK, NUMBER OF FALLS)

PAY ATTENTION! TURRET ROTATION ENABLED! →

12.4. PICK & CARRY FUNCTIONS

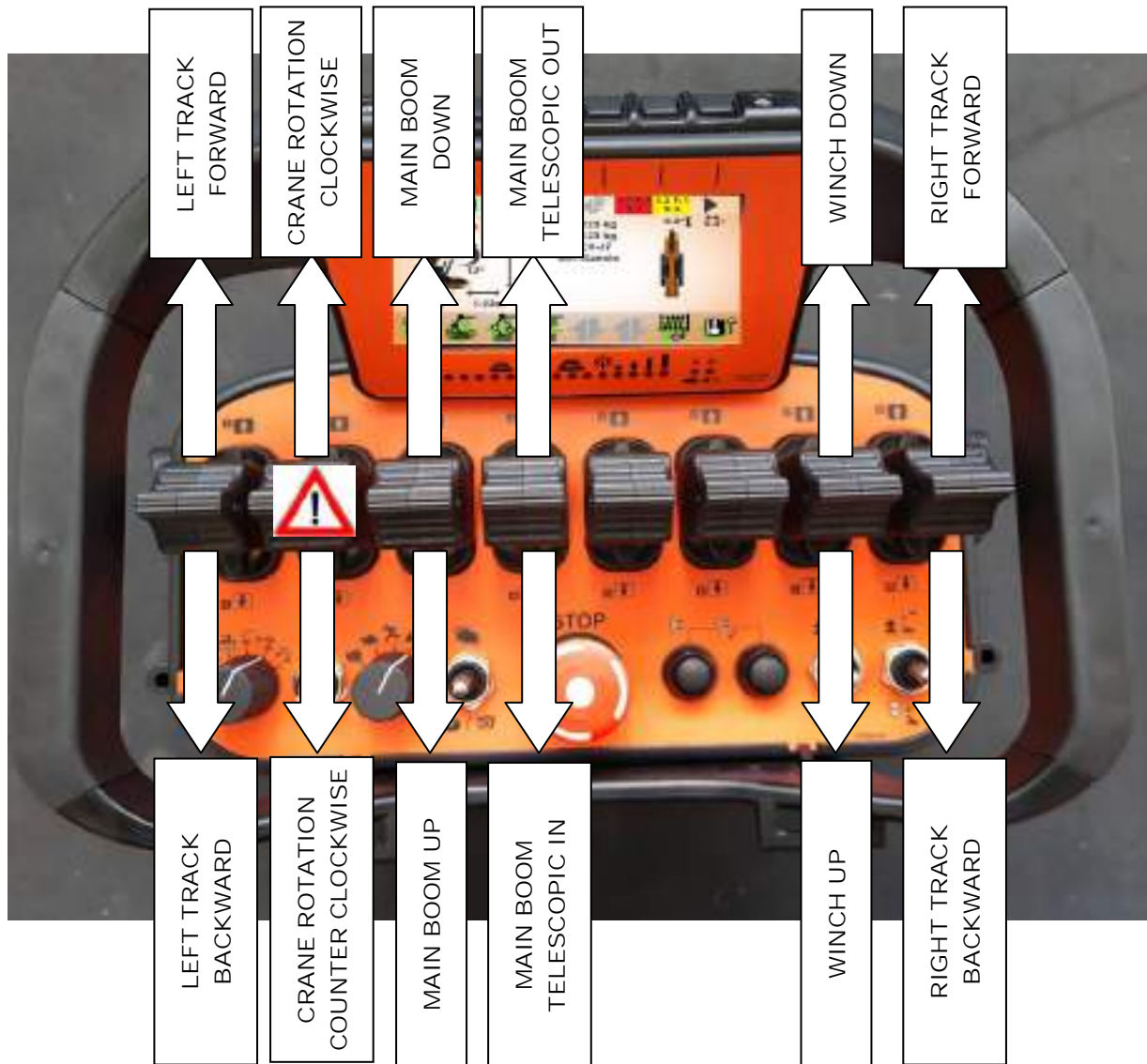

WARNING!

The turret rotation function is enabled!

The winch functions are automatically disabled when working in hook mode!

12.5. PICK & CARRY LIMITATIONS

When the machine is operated in Pick & Carry mode:

- **Crane turret rotation function is enabled only if working in main boom configurations** (turret rotation is automatically disabled when doing Pick & carry with JIB1000.2H configurations);
- Check the Technical Data for further details about the lifting capacity and geometrical limitations.

12.6. PICK & CARRY ROTATION INTERFERENCE (WITH MAIN BOOM)

When working in **Pick & Carry mode with the main boom**, the turret rotation functions are enabled!

Don't operate the rotation function when the outriggers are completely folded, or you will damage them!

TURRET ROTATION IS ENABLED!!!



13. MACHINE STABILITY (NO FUNCTIONS AVAILABLE)

Rotate the *Working mode selector* in position  and the screen beside will be displayed.

In this page the operator can check the machine stability (extension and swing rotation angles of outriggers).





There are no functions associated to this working mode, for this reason there are no functions associated to the levers.



This page can be displayed even by scrolling the pages with the *Arrow right button* ().

13.1. WORKING ZONES AND LIFTING CAPACITY

From Stability page the operator can check the lifting capacity of each sector and also the turret rotation angles that limit each working zone (see the picture above).

-  **J0 (RED SECTOR) = NO WORKING ZONE (accessible only for parking the crane)**
-  **J1 (GREY SECTOR) = PICK & CARRY CHART**
-  **J5 (YELLOW SECTOR) = 50% APPROX. LIFTING CAPACITY**
-  **J6 (ORANGE SECTOR) = 75% APPROX. LIFTING CAPACITY**
-  **J7 (GREEN SECTOR) = 100% LIFTING CAPACITY**

The load charts J2, J3 and J4 are not used.





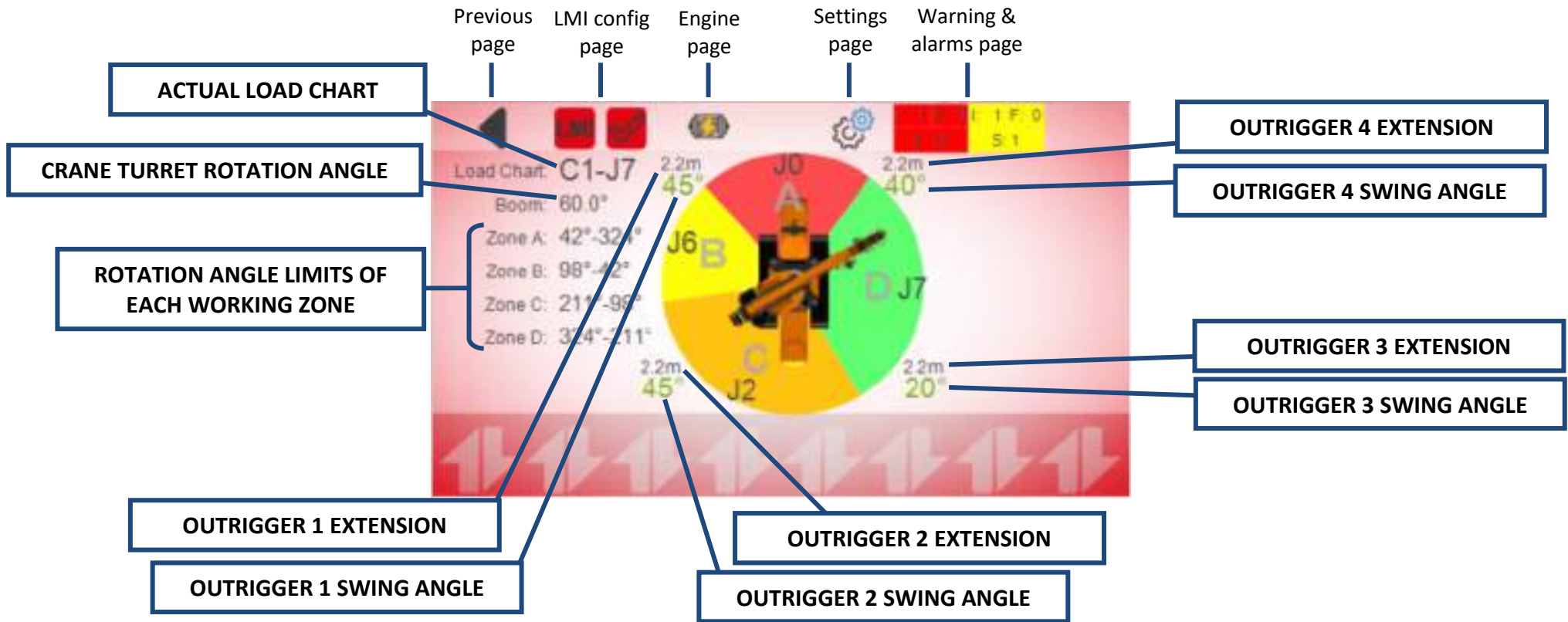

13.2. MACHINE STABILITY SCREEN APPEARANCE



14. ENGINE POWER MODE SELECTOR

The operator can select the engine power mode by rotating the *Engine power mode selector* on the remote control: the power modes adjust the working pressure (force), the oil displacement (speed) and therefore the performance of the crane.

-  **Min. Speed (Max Force)**
-  **Slow Speed**
-  **Fast Speed**
-  **Super fast speed**
-  **Auto Mode (Speed VS Force)**

$$P [W] = p [bar] \times Q \left[\frac{l}{min} \right]$$

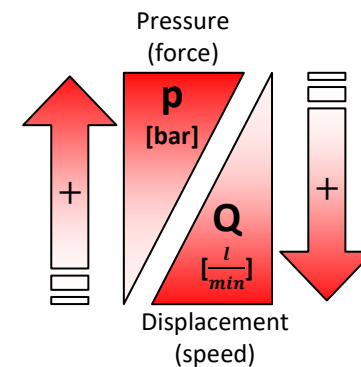

According to the power mode selected, the background color of the remote control screen will change

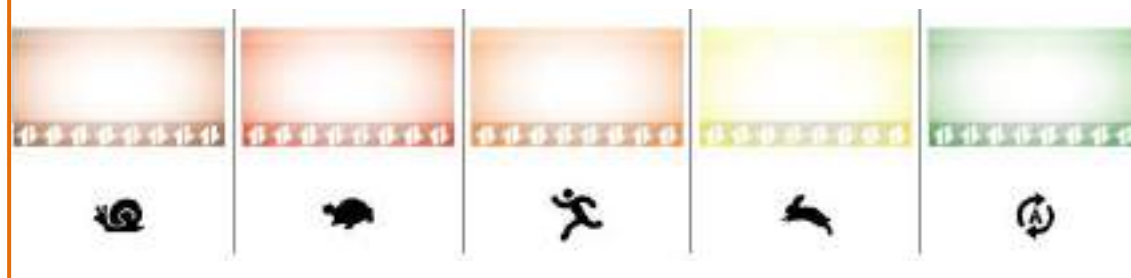

15. WINCH SPEED REDUCTION SELECTOR

The operator can regulate gradually the winch speed by using the *Winch speed reduction selector*: the speed can be adjusted even while operating the function itself.



Increase winch



Reduce winch

15.1. SPEED INDICATOR

The color of the icons (on the bottom of the display) will indicate the speed of the winch.



Green color → $100\% \leq \text{Speed} \leq 40\%$



Yellow color → $40\% \leq \text{Speed} \leq 20\%$

16. CRANE SPEED REDUCTION SELECTOR

The operator can regulate gradually the speed of all crane functions (winch included) by pushing up or down the *Crane speed reduction selector*: the speed can be adjusted even while operating the functions.



Increase speed of all crane functions (winch included)



Reduce speed of all crane functions (winch included)

16.1. SPEED INDICATOR

The color of the icons (on the bottom of the display) will indicate the speed of the winch and track functions.



Green color → $100\% \leq \text{Speed} \leq 40\%$



Yellow color → $40\% \leq \text{Speed} \leq 20\%$

17. ALARMS & WARNINGS

If any alarm or warning is active, the code will be displayed on top of the screen. When there are more alarms or warnings active, the codes will roll (see the picture below).



ALARM CODE ACTIVE

WARNING CODE ACTIVE

ALARMS & WARNING CODES:

Each alarm or warning code is composed by:

- **ID:** is the can bus unit/electronic device involved (example: 1 = SPN06)
- **FMI:** is the family/group;
- **SPN:** a generic progressive number; each family (FMI) has its own list which could restart from 1 or not.

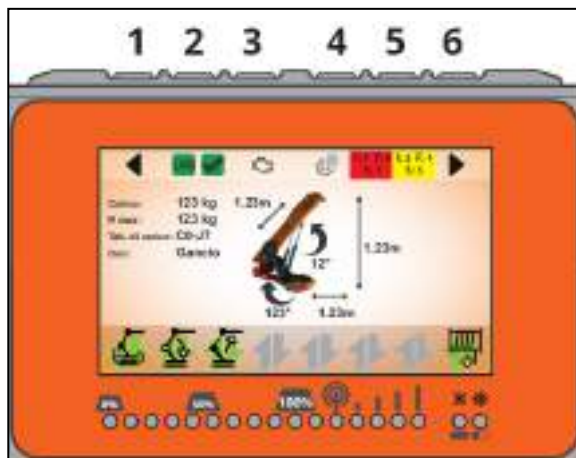

IMPORTANT: Referring to alarm or warning codes, always indicate and specify ID, FMI and SPN to identify it.

Push the Button 5 of the remote control (on top of the display) to open the Warning page and Alarm page.

17.1. ALARM PAGE

In the Alarm page, the alarms are listed with a brief description that helps to understand the faults / possible causes.

HOW TO CLEAN ALARMS:

To clean the alarms press and hold the *Button 6* (on top of the display) for 2 seconds.

If the alarms don't disappear, do it twice!

By cleaning the alarms pushing *Button 6*, only the active alarms will remain written in the alarm list.

For further details, please check the “SPX532 WARNING AND ALARM CHART”.

Push the *Button 2* (on top of the display) to open the Warning page (see page 37).

NOTE: The alarm page has got the yellow symbol here!

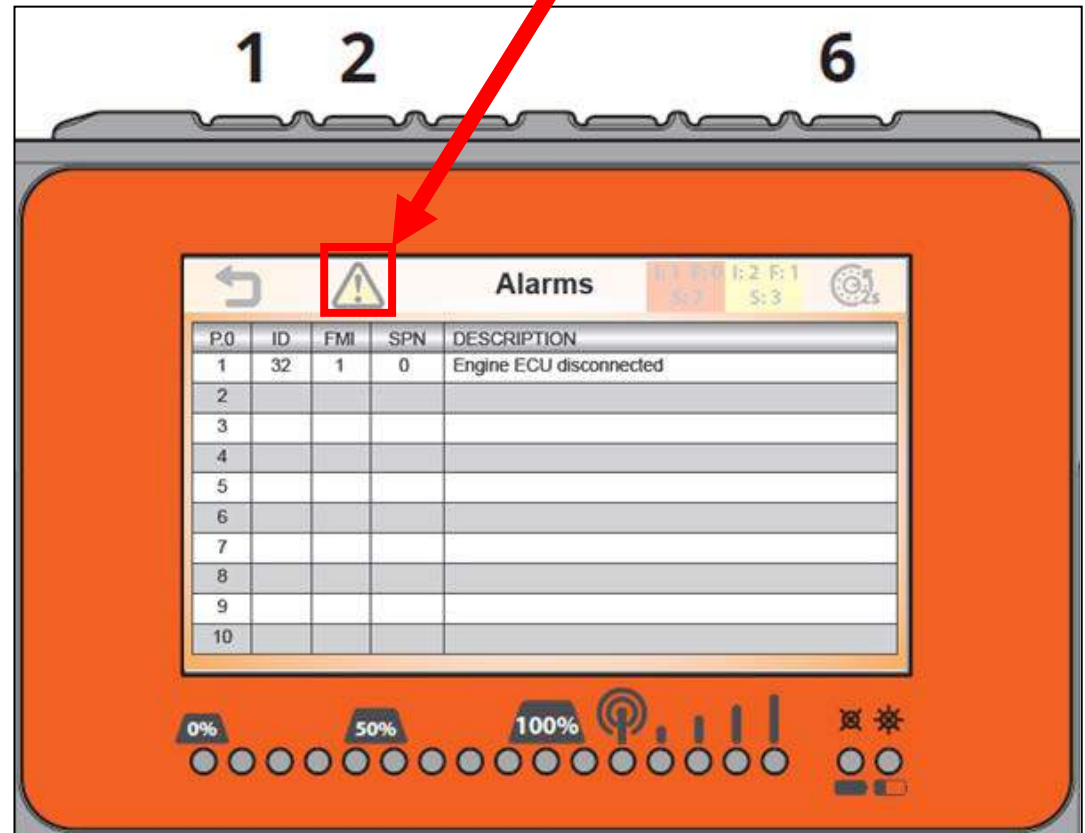

17.2. WARNING PAGE

In the Warning page, the warnings are listed with a brief description that helps to understand the possible causes.

IMPORTANT:

The warning code is displayed only while the operator is trying to operate the not-allowed function!

For this reason, to read the warning code and its description, you must hold the joystick or the function until the code is displayed.

DEFINITION:

A warning blocks only one or more specific functions that are not allowed for some reason

related to the machine configuration or to the context: a warning cannot be cleaned like the alarms!

(example: **A2B rope fully in limit-switch is activated** → Warning code ID:1 FMI:0 SPN:2

Description: *Block by fully winded rope (A2B)*

Effect: Winch up function and telescopic out functions are locked)

NOTE: The warning page has got the red symbol!

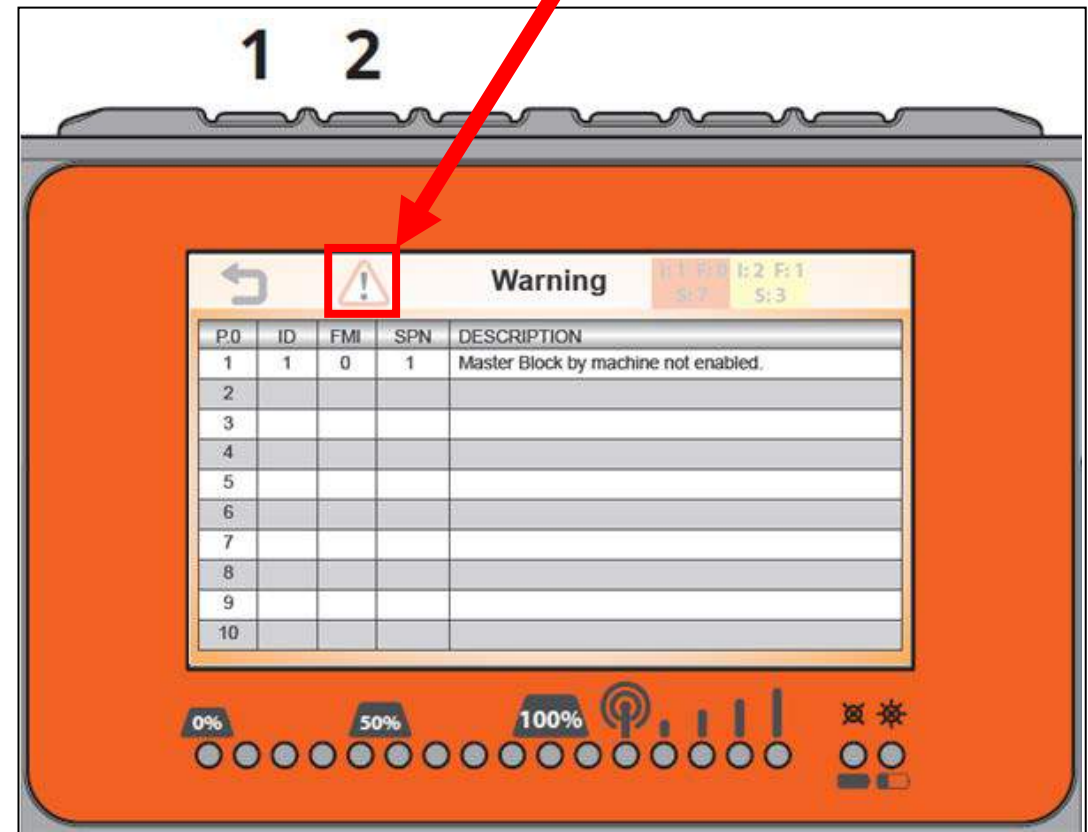

17.3. WARNING “BLOCK BY MACHINE NOT ENABLED”

Warning code: *ID:1 FMI:0 SPN:1*
Description: *Block by machine not enabled*
Effect: *The working mode selected cannot be enabled (working mode selector)*

Working mode selector

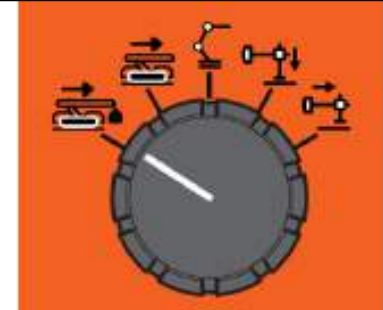

- Suggestions:**
- 1) Verify that all the conditions to enable the working mode selected are fulfilled!
 - 2) Go into the Warning page
 - 3) Press and hold the **Start button** of the remote control for few seconds (the horn will sound): on the Warning page will be displayed one or more warning codes to explain why the working mode selected can't be enabled!

In this way the machine will tell you why the working mode cannot be enabled, and which is the condition not respected!

