

The logo for HIRD, featuring the word "HIRD" in bold yellow capital letters inside a blue square. The square is framed by two white curved lines, one above and one below the text. Below the square, the website address "www.hird.co.uk" is written in white.

HIRD

www.hird.co.uk

OPERATORS MANUAL

MAEDA MINI CRANE MC174



Northern (Head Office)
Tel: +44 (0)1482 227333

Central
Tel: +44 (0)1302 341659

Western
Tel: +44 (0)1384 900388

Southern
Tel: +44 (0)203 174 0658

CONTENTS

ITEM	Page
INTRODUCTION	1- 1
1. INTRODUCTION	1- 2
2.FOR SAFE USE OF MACHINE	1- 3
3. MACHINE OVERVIEW	1- 4
3.1 SPECIFIED OPERATIONS	1- 4
3.2 MACHINE CONFIGURATION	1- 4
3.3 MACHINE FUNCTIONS	1- 5
4. QUALIFICATION FOR OPERATION	1- 6
4.1 QUALIFICATION FOR CRANE OPERATION	1- 6
5. TERMINOLOGY	1- 7
5.1 DEFINITION OF TERMS	1- 7
5.2 DIAGRAM OF WORKING RADIUS AND LIFTING HEIGHT	1- 8
5.3 TOTAL RATED LOAD CHART	1- 9
5.4 ANGLE INDICATOR	1-14
SAFETY	2- 1
1. BASIC PRECAUTIONS	2- 2
2. DRIVING RELATED PRECAUTIONS	2- 7
2.1 BEFORE STARTING THE ENGINE	2- 7
2.2 AFTER STARTING THE ENGINE	2- 8
2.3 WORKING WITH THE CRANE	2-12
3. TRANSPORT PRECAUTIONS	2-21
4. BATTERY HANDLING PRECAUTIONS	2-23
5. MAINTENANCE PRECAUTIONS	2-25
5.1 PRECAUTIONS BEFORE MAINTENANCE	2-25
5.2 PRECAUTIONS DURING MAINTENANCE	2-27
6. SAFETY LABEL LOCATIONS	2-32
7. WEEE DIRECTIVE LABEL LOCATIONS	2-39
OPERATION	3- 1
1. MACHINE BY SECTION	3- 2
1.1 MACHINE BY UNIT	3- 2
1.2 TRAVELLING OPERATION UNIT	3- 3
1.2.1 DESCRIPTION OF EACH LEVER	3- 4
1.2.2 DESCRIPTION OF EACH SWITCH	3- 6
1.2.3 DESCRIPTION OF EACH METER AND LAMP	3- 8
1.3 CRANE OPERATION UNITS	3- 9
1.3.1 DESCRIPTION OF EACH LEVER	3-10
1.3.2 DESCRIPTION OF EACH SWITCH	3-11
1.4 MOMENT LIMITER (OVERLOAD DETECTOR)	3-16
1.4.1 MOMENT LIMITER CONFIGURATION	3-16
1.4.2 FUNCTION OF MOMENT LIMITER	3-17
1.4.3 MOMENT LIMITER OPERATIONS	3-18

ITEM	Page
1.4.4 NAMES OF MOMENT LIMITER DISPLAY UNIT	3-20
1.4.5 OTHER MOMENT LIMITER FUNCTIONS	3-29
1.4.6 MOMENT LIMITER STARTING STATUS	3-30
1.4.7 MOMENT LIMITER ERROR CAUSES AND ACTIONS TO BE TAKEN	3-31
1.5 OVER HOIST DETECTOR	3-32
1.6 MACHINERY COVER	3-33
2. OPERATIONS	3-34
2.1 CHECKS BEFORE OPERATION	3-34
2.1.1 CHECKS BEFORE STARTING THE ENGINE (VISIBLE CHECKS)	3-34
2.1.2 CHECKS BEFORE STARTING THE ENGINE	3-37
2.1.3 CHECKS AFTER STARTING THE ENGINE	3-46
2.2 STARTING THE ENGINE	3-54
2.2.1 NORMAL ENGINE START	3-54
2.2.2 STARTING THE ENGINE WITH AUXILIARY STARTER SWITCH	3-56
2.2.3 STARTING THE ENGINE WITH RECOIL STARTER	3-58
2.3 OPERATIONS AND CHECKS AFTER STARTING THE ENGINE	3-59
2.4 BREAKING-IN MACHINE	3-61
2.5 MACHINE TRAVELLING POSITION	3-61
2.6 STARTING MOVING THE MACHINE	3-62
2.7 CHANGING MACHINE TRAVELLING MODE	3-63
2.8 CHANGING DIRECTION OF THE MACHINE	3-63
2.9 STOPPING/PARKING THE MACHINE	3-64
2.10 STOPPING THE ENGINE	3-65
2.11 INSPECTION AFTER STOPPING THE ENGINE	3-65
2.12 CAUTIONS WHILE DRIVING	3-66
2.13 OUTRIGGER SET UP OPERATION	3-68
2.13.1 NAME OF OUTRIGGER COMPONENTS	3-70
2.13.2 OUTRIGGER SET UP OPERATION	3-70
2.14 CAUTIONS BEFORE CRANE OPERATION	3-75
2.15 OPERATIONS BEFORE CRANE OPERATIONS	3-76
2.16 CRANE OPERATION POSITION	3-77
2.17 HOOK RAISING/LOWERING OPERATION	3-78
2.18 BOOM DERRICKING OPERATION	3-79
2.19 BOOM TELESCOPING OPERATION	3-80
2.20 SLEWING OPERATION	3-81
2.21 ACCELERATION OPERATION	3-82
2.22 CRANE STOWING OPERATION	3-83
2.23 OUTRIGGER STOWING OPERATION	3-85
2.24 DO'S AND DON'TS DURING CRANE OPERATIONS	3-91
3. HANDLING RUBBER TRACKS	3-93
3.1 GOOD USE	3-93
3.2 WARRANTY	3-93
3.3 PROHIBITIONS AND CAUTIONS WHEN USING RUBBER TRACKS	3-94
4. WHAT TO DO WITH TWISTED WINCH WIRE ROPE	3-97

ITEM	Page
5. TRANSPORTATION	3-98
5.1 LOADING/UNLOADING	3-98
5.2 HOISTING MACHINE	3-99
5.3 CAUTIONS IN LOADING MACHINE	3-100
5.4 CAUTIONS DURING TRANSPORTATION	3-100
6. HANDLING IN COLD WEATHER	3-101
6.1 PREPARING FOR LOW TEMPERATURE	3-101
7. LONG-TERM STORAGE	3-103
7.1 BEFORE STORING THE MACHINE	3-103
7.2 DURING STORAGE	3-103
7.3 AFTER STORAGE	3-103
8. HANDLING THE BATTERY	3-104
8.1 CAUTIONS IN HANDLING BATTERY	3-104
8.2 REMOVING/INSTALLING THE BATTERY	3-105
8.3 CAUTIONS WHEN CHARGING THE BATTERY	3-106
8.4 STARTING THE ENGINE WITH BOOSTER CABLE	3-107
9. TROUBLESHOOTING	3-109
9.1 ELECTRICAL COMPONENTS	3-109
9.2 MACHINE BODY	3-109
9.3 ENGINE	3-110
INSPECTION AND MAINTENANCE	4- 1
1. PRECAUTIONS FOR MAINTENANCE	4- 2
2. BASIC MAINTENANCE	4- 4
3. LEGAL INSPECTION	4- 6
4. CONSUMABLES	4- 6
5. LUBRICATING OIL	4- 7
5.1 USE OF LUBRICATING OIL ACCORDING TO TEMPERATURES	4- 7
6. ACCESSORY TOOLS AND STANDARD TIGHTENING TORQUE	4- 8
6.1 ACCESSORY TOOLS	4- 8
6.2 STANDARD TIGHTENING TORQUE LIST	4- 8
7. INSPECTION AND MAINTENANCE LIST	4-10
8. MAINTENANCE PROCEDURES	4-12
8.1 INITIAL 10 HOUR MAINTENANCE	4-12
8.2 INITIAL 25 HOUR MAINTENANCE	4-12
8.3 INITIAL 50 HOUR MAINTENANCE	4-12
8.4 INITIAL 200 HOUR MAINTENANCE	4-12
8.5 CHECKS BEFORE OPERATION	4-12
8.6 IRREGULAR MAINTENANCE	4-13
8.7 MAINTENANCE EVERY 50 HOURS	4-24
8.8 MAINTENANCE EVERY 100 HOURS	4-30
8.9 MAINTENANCE EVERY 250 HOURS	4-30
8.10 MAINTENANCE EVERY 500 HOURS	4-31
8.11 MAINTENANCE EVERY 1000 HOURS	4-33

ITEM	Page
SPECIFICATIONS	5- 1
1. SPECIFICATIONS	5- 2
2. OVERALL DIMENSIONS	5- 4
3. OUTRIGGER SPREAD DIMENSIONS	5- 5
4. RATED TOTAL LOAD CHART	5- 6
5. WORKING RANGE	5- 9
REMOTE CONTROL	6- 1
1. OUTLINE OF REMOTE CONTROLLER	6- 2
1.1 FEATURE	6- 2
1.2 CONFIGURATION	6- 2
1.3 FUNCTIONS OF REMOTE CONTROL SYSTEM	6- 3
2. SAFETY PRECAUTIONS	6- 4
2.1 FOR SAFETY OPERATIONS	6- 4
2.2 PRECAUTIONS FOR CRANE OPERATION	6- 6
2.2.1 PRIOR TO STARTING ENGINE	6- 6
2.2.2 SUBSEQUENT TO STARTING ENGINE	6- 7
2.2.3 TERMINATING THE OPERATION	6- 7
3. LOCATIONS OF SAFETY LABELS	6- 8
4. COMPONENTS OF THE TRANSMITTER	6-10
5. COMPONENTS OF THE RECEIVER	6-15
5.1 COMPONENTS OF THE RECEIVER	6-15
5.2 FUSE IN THE RECEIVER	6-17
6. MODE SETTING OF THE TRANSMITTER	6-18
6.1 A MODE	6-18
6.1.1 OPENING A MODE SCREEN	6-18
6.1.2 MESSAGES IN THE A MODE SCREEN	6-18
6.1.3 AN EXAMPLE FOR SETTING IN THE A MODE	6-22
6.2 PROCEDURE IN THE OPERATION MODE	6-23
6.2.1 CALL OUT CRANE MODE	6-23
6.2.2 CALL OUT OUTRIGGER MODE	6-24
7. CHECKING BEFORE OPERATION	6-26
7.1 CHECKING BEFORE STARTING ENGINE	6-26
7.1.1 CHECKING BEFORE TURNING ON THE TRANSMITTER	6-26
7.1.2 CHECKING AFTER TURNING ON THE TRANSMITTER	6-27
7.1.3 CHECKING RECEIVER	6-31
7.2 CHECKING AFTER STARTING ENGINE	6-32
7.2.1 VERIFICATION FOR THE ENGINE START AND STOP	6-32
7.2.2 CHECKING "OUTRIGGER MODE" OPERATION	6-33
7.2.3 CHECKING "CRANE MODE" OPERATION	6-35
8. OPERATION	6-38
8.1 CAUTIONS BEFORE OPERATION	6-38
8.2 OPERATION IN OUTRIGGER MODE	6-39
8.2.1 OUTRIGGER SETTING	6-41
8.2.2 OUTRIGGER STOWING	6-43

ITEM	Page
8.3 OPERATION IN CRANE MODE	6-44
8.3.1 SLEWING OPERATION	6-46
8.3.2 BOOM TELESCOPING	6-46
8.3.3 HOOK RAISING AND LOWERING	6-47
8.3.4 BOOM DERRICKING	6-47
8.3.5 SET-UP AND CANCEL MICRO SPEED	6-48
8.3.6 ENGINE STOP AND EMERGENCY STOP PROCEDURE	6-50
8.3.7 ENGINE START AND RESET PROCEDURE	6-50
8.4 CHECKING AFTER CRANE OPERATION	6-51
9. TROUBLE SHOOTING	6-52
9.1 BEFORE TROUBLE SHOOTING	6-52
9.2 ERRORS IN THE REMOTE CONTROL DEVICES	6-53
10. SYSTEM SPECIFICATIONS	6-55

INTRODUCTION

1. INTRODUCTION	1- 2
2. FOR SAFE USE OF MACHINE	1- 3
3. MACHINE OVERVIEW	1- 4
4. QUALIFICATION FOR OPERATION	1- 6
5. TERMINOLOGY	1- 7

1. INTRODUCTION

Thank you for purchasing our Mini Crawler Crane “MC-174CRM”.

This manual is a guidebook for the safe and effective use of this machine.

This manual describes the procedures for proper operation and maintenance of the machine.

Warnings and precautions defined in this manual must be observed for safety.

Accidents are caused when operation, inspection, or maintenance is not followed according to these guidelines.

Be sure to read this manual and understand the procedures for machine operation, inspection, and maintenance thoroughly before operating this machine.

Failure to observe the basic precautions defined in this manual may lead to hazardous accidents.

WARNING

Failure to use this machine properly can lead to serious personal injury or death. Operators and maintenance personnel must always read this manual prior to operation or maintenance of this machine.

Save this manual at a designated place for reference when necessary. All personnel who work on this machine are to carry out periodic reference.

- **Only those who have a thorough understanding of the fundamental procedures provided in this manual are qualified to perform machine operation.**
- **Keep this manual handy for reference when necessary.**
- **Should you lose or damage this manual, contact Maeda or our sales service agency immediately for ordering a new manual.**
- **This manual should always accompany this machine upon transfer of the machine to the next owner.**
- **This manual has adopted data that was available at the time of the creation of the manual.**

The contents of this manual, including maintenance specifications, tightening torque, pressure, measuring method, adjustment value, and illustrations, are subject to change upon unremitting refinement of the machine, without notice.

Machine maintenance may be susceptible to revisions. Always obtain the latest information from Maeda or our sales service agency before performing maintenance of this machine.

For safety instructions, see “2. For Safe Use of Machine” on page 1-3 and “Safety” on page 2-1.

2. FOR SAFE USE OF MACHINE

This manual classifies the risks into the following three categories to present the details of the safety labels in easy-to-understand manner.



! DANGER

This denotes that there is an imminent hazard which will cause serious personal injury or death.

Follow instructions to avoid danger.



! WARNING

This denotes that there is a hazard which can cause serious personal injury or death.

Follow instructions to avoid danger.



! CAUTION

This denotes that there is a potential hazard which may cause minor or moderate personal injury or serious damage to this machine.

Follow instructions to avoid danger.

This manual also provides the following to indicate what must be observed for the sake of the machine and what will be of help.



CAUTION

This denotes that failure to handle the machine properly may damage the machine or shorten its life.



NOTES

This denotes helpful information.

This manual covers not only procedures for operation, inspection, and maintenance of this machine, but also safety precautions where this machine is only used for specified tasks.

Not every event is foreseeable and therefore, cautions given in this manual and on this machine do not necessarily cover every safety-related issue.

The result of operation, inspection, and maintenance carried out in a way that is not described in this manual are your responsibility.

Even in the above case, never attempt any work or operation that this manual prohibits you to do.

3. MACHINE OVERVIEW

3.1 SPECIFIED OPERATIONS

This machine is to be used for operation listed below.

- Crane operation

This machine is a mobile crane with a rubber track travelling dolly (carrier) mounted with a boom crane. This self-propelled crane is capable of moving (travelling) in the worksite and craning an object weighing within the rated total load.

This is also a remote-controlled crane.

3.2 MACHINE CONFIGURATION

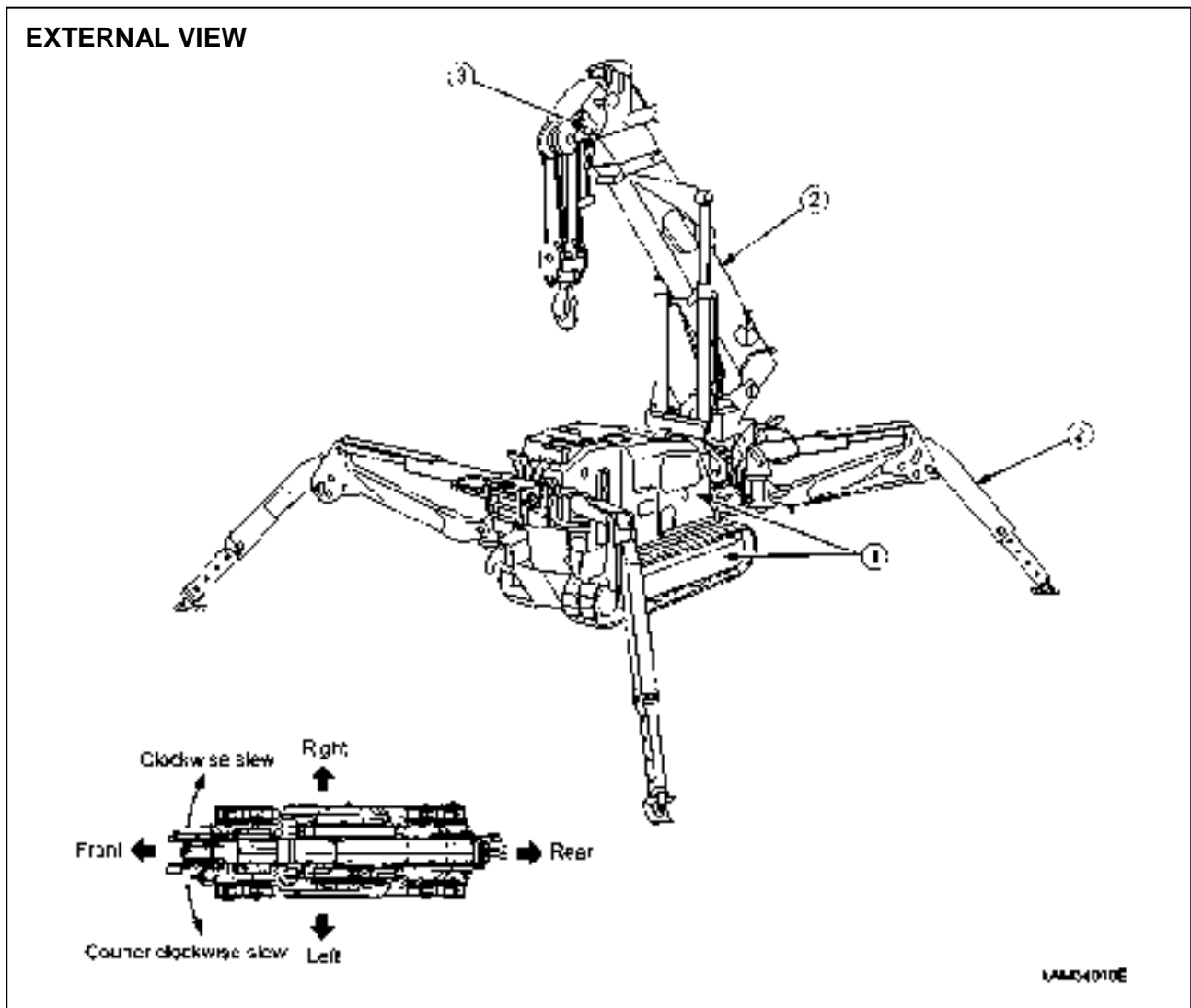

- (1) Travelling dolly
- (2) Crane
- (3) Safety device

Viewed from the operator's seat, the front, back, left, and right of the machine are determined in this manual, viewing in the travelling direction (front) of the machine.

Boom slewing motion is determined with the machine viewed from immediately above; slew clockwise denotes right-handed motion and slew counterclockwise denotes left-handed motion.

This machine is composed of the units listed below.

[1] TRAVELLING DOLLY

This is composed of a travelling gear, engine, travelling operation unit, and crane operation unit.

[2] CRANE

This is composed of a telescoping system, derrick system, hook block, winch system, and outrigger system.

[3] SAFETY DEVICE

This is composed of the following parts and devices: Over hoist detector/automatic stop device, angle indicator, hydraulic safety valve, hydraulic automatic locking device, slinging rope detachment protector, alarm buzzer, audio alarm, level, crane tip-over alarm (an alarm issued in the event of the crane operation at 3-degree inclination and travelling at 15-degree inclination), travelling lever lock, travelling/crane selector switch (designed to prevent the machine from craning at travelling), moment limiter (working envelope limited), working status lamp.

3.3 MACHINE FUNCTIONS

[1] TRAVELLING DOLLY

- This is a compact machine designed to keep the overall width between the crane and outrigger minimized with them housed (in travelling position).
This compact design is ideal for work in confined areas.
- Two-travelling lever operation enables not only direction changes among forward, backward, and right/left but pivot turn and spin turn.

[2] CRANE

- An automatic slide outrigger is included in the crane to permit outrigger extension and grounding from the operator's station.
- Through the combined use of telescoping, derricking, slewing, and winch system operation, the crane is capable of raising or lowering the hook block and moving an object weighing within the rated total load to a designated position within the confines of the working envelope.
- Remote-control units allow remote outrigger setting and remote crane operation.

4. QUALIFICATION FOR OPERATION

WARNING

- A high incidence of occupational accidents in crane operation has been reported. Be aware that experienced engineers are also no exception.
- Warnings and precautions defined in this manual shall be observed for safety assurance during operation of the machine.

4.1 QUALIFICATION FOR CRANE OPERATION

Only personnel that have obtained the correct training or license stipulated by laws and regulations applicable to the place of use are qualified to operate this machine.

Contact the relevant government office or our sales service agency for further information.

5. TERMINOLOGY

5.1 DEFINITION OF TERMS

[1] RATED TOTAL LOAD

This is the maximum load that can be applied according to a boom length and angle. The load includes the mass (weight) of hoisting accessories (hooks) and slinging ropes.

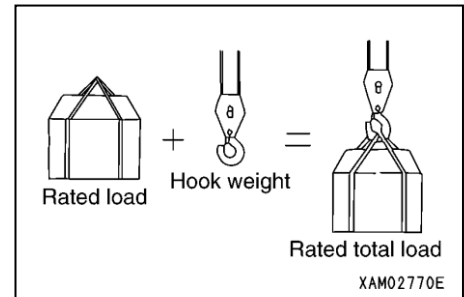

[2] RATED LOAD

This is a load derived by subtracting the mass (weight) of hoisting accessories (hooks) and slinging ropes from the rated total load, which is a withstand load for hoisting.

[3] WORKING RADIUS

This is a horizontal distance between the axis of slewing and the hook center.

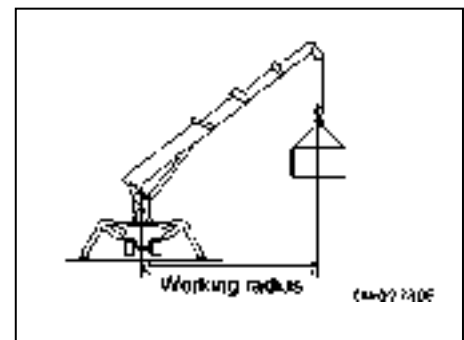

[4] BOOM LENGTH

This is a distance between the boom primary pin and the sheave pin of the end boom.

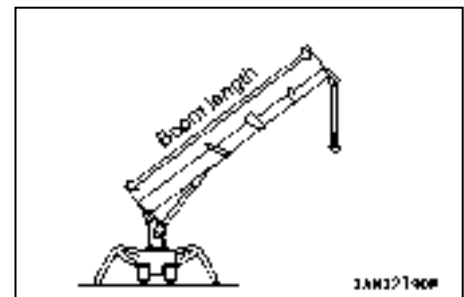

[5] BOOM ANGLE

This is an angle which the boom forms with the horizontal plain.

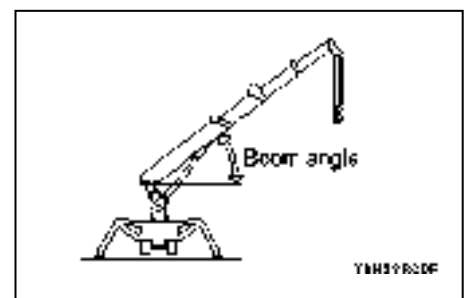

[6] LIFTING HEIGHT ABOVE GROUND

This is a vertical distance between the hook bottom and the ground with the hook raised to the upper limit.

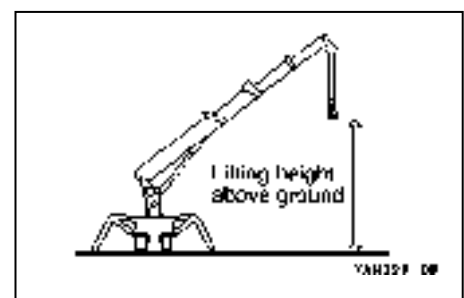

5.2 DIAGRAM OF WORKING RADIUS AND LIFTING HEIGHT

⚠ WARNING

- The diagram of working radius and lifting height shows the relationships between the working radius of this machine, boom angle, and lifting height above the ground with no object hoisted. The diagram has been made allowing for no deflection in the boom.
- The boom (4) in the diagram of working radius and lifting height represents a state that half of the “ mark” passes boom (3).

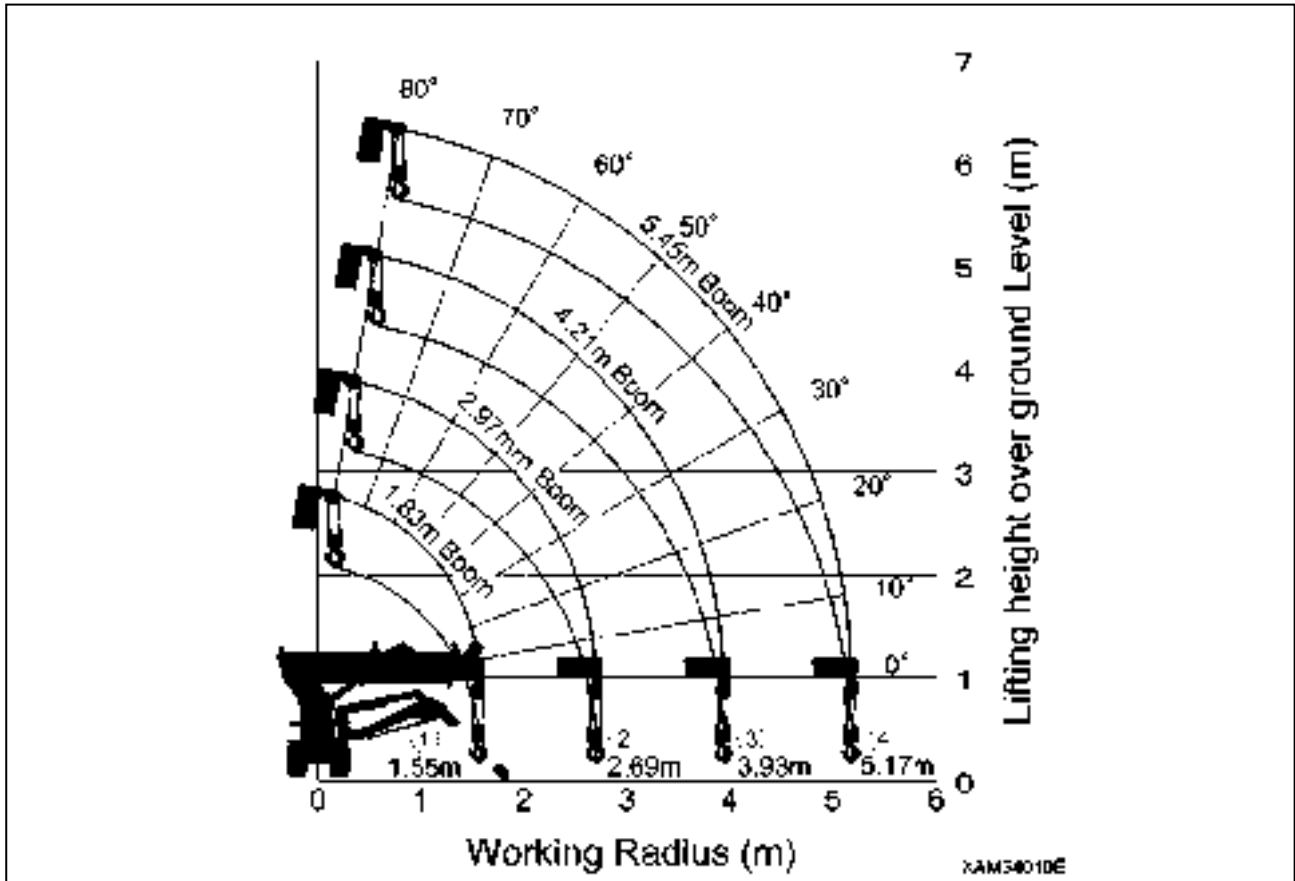

1. Point A denotes a boom angle and point B denotes a lifting height above ground in the figure at right.
The same working radius is applied to points A and B.

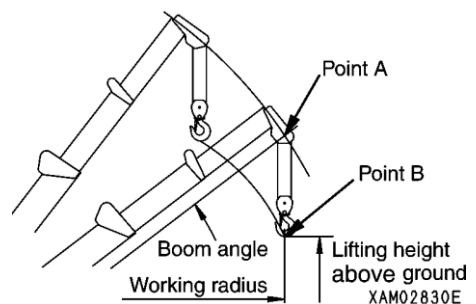

2. The “diagram of working radius and lifting height” shows the relationships the working radius, boom angle, and lifting height at no load, allowing for no deflection in the boom. A deflection occurs in the boom when an object is hoisted, which causes the working radius to widen slightly. The rated total load decreases with increase in the working radius. Actual crane operation requires the planning of work, allowing for sufficient clearance more than that provided in the diagram.

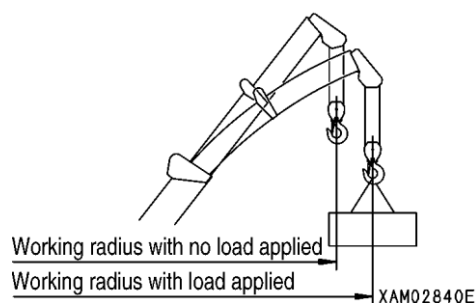

5.3 TOTAL RATED LOAD CHART

⚠ CAUTION

- All the values provided in the total rated load chart are based on the assumption that the machine is placed on a level and firm surface.
The machine may topple over if proper outrigger setting or ground condition fails to be assured. Exercise due caution when performing crane operation.
- The values in the total rated load chart are determined based on the working radius allowing for deflection that is developed when load is applied to the boom.
- When extending 3rd boom even if only slightly, crane operation should proceed to the extent of performance of "4.21m Boom".
- When half of the "⚠ mark" passes 2nd boom, crane operation should proceed to the extent of performance of "5.45m Boom".
- If the working radius exceeds that stated in the table even if only slightly, crane operation should proceed with respect to the rated total load corresponding to the working radius in the following table.
- The rated total load is a load including the mass of a hoisting accessory (hook: 20kg).
- When the crane is used with the outriggers extended other than at the maximum, crane operation should proceed with respect to the values specified in the total rated load chart corresponding to Rated Total Load Chart with outrigger extended to other than Maximum.

Rated Total Load Chart with outrigger extended to maximum								Rated Total Load Chart with outrigger extended to other than maximum							
1.83m Boom		2.97m Boom		4.21m Boom		5.45m Boom		1.83m Boom		2.97m Boom		4.21m Boom		5.45m Boom	
Working Radius (m)	Rated Total Load (t)	Working Radius (m)	Rated Total Load (t)	Working Radius (m)	Rated Total Load (t)	Working Radius (m)	Rated Total Load (t)	Working Radius (m)	Rated Total Load (t)	Working Radius (m)	Rated Total Load (t)	Working Radius (m)	Rated Total Load (t)	Working Radius (m)	Rated Total Load (t)
0.0	1.72	0.0	1.72	0.0	1.32	0.0	0.77	0.0	1.22	0.0	1.22	0.0	0.94	0.0	0.72
1.3	1.32	1.3	1.32	1.5	1.12	2.0	0.70	1.3	0.94	1.3	0.94	1.5	0.81	2.0	0.60
1.55	1.09	1.5	1.12	2.0	0.82	2.5	0.66	1.55	0.79	1.5	0.81	2.0	0.60	2.5	0.39
		2.0	0.82	2.5	0.67	2.8	0.58			2.0	0.60	2.5	0.39	2.8	0.33
		2.5	0.67	3.0	0.53	3.0	0.53			2.5	0.39	3.0	0.30	3.0	0.30
		2.69	0.58	3.5	0.42	3.5	0.41			2.69	0.31	3.5	0.22	3.5	0.22
				3.93	0.37	4.0	0.33					3.93	0.18	4.0	0.18
						4.5	0.27							4.5	0.14
						5.17	0.22							5.17	0.10

1. The Rated Total Load Chart is based on actual working radius with the bending of boom attributable to load collected and it shows with the mass of hook (20kg) included when.
 2. If third stage boom is extended to any extent work should be performed within the capacity for "Boom 4.21m".
 3. If one half or more of the mark ⚠ is passed from second boom work should be performed within the capacity for "Boom 5.45m".
 4. Rough total weight of crane is extremely important. Such is self operation.

XAM04020E

The total rated load chart provides the maximum loads that the crane is capable of hoisting objects in parallel with the length of the boom. The loads are specified by working radius.

[1] BOOM LENGTH

The following figures illustrate the condition of the booms, “1.83m Boom”, “2.97m Boom”, “4.21m Boom” and “5.45m Boom” in the preceding boxes in the total rated load chart.

1. “1.83m Boom”: All the booms are retracted.

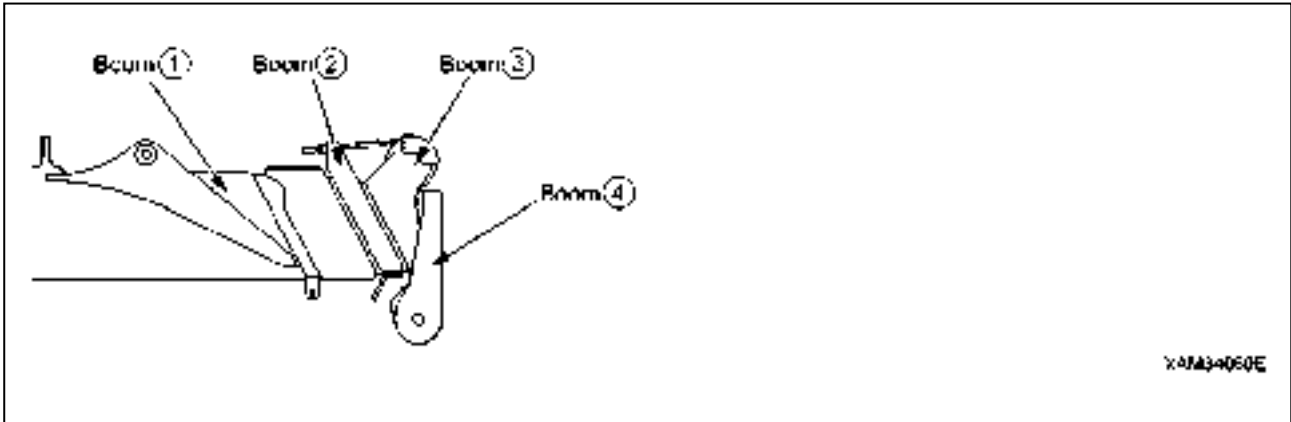

2. “2.97m Boom”: With booms (3) and (4) retracted, boom (2) is fully extended.

“2.97m Boom” is to apply to crane operation with boom (2) extended even if only slightly.

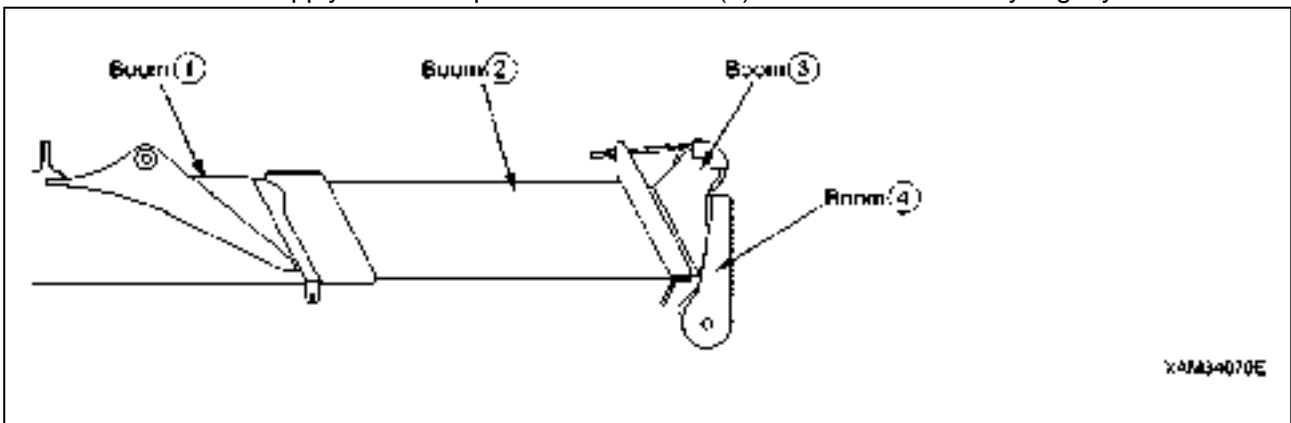

3. “4.21m Boom”: With booms (2) fully extended, booms (3) and (4) are extended midway (half of the “ mark” passes boom (2)).

“4.21m Boom” is to apply to crane operation with booms (3) and (4) extended even if only slightly.

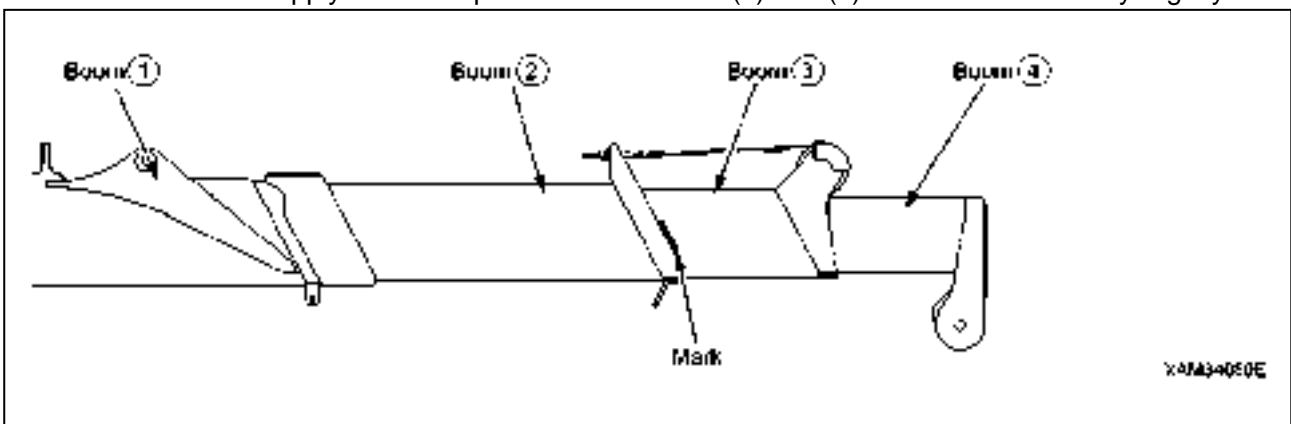

4. "5.45m Boom": All the booms are fully extended.

"5.45m Boom" is to apply to crane operation with half of the "L mark" on boom (3) passes boom (2).

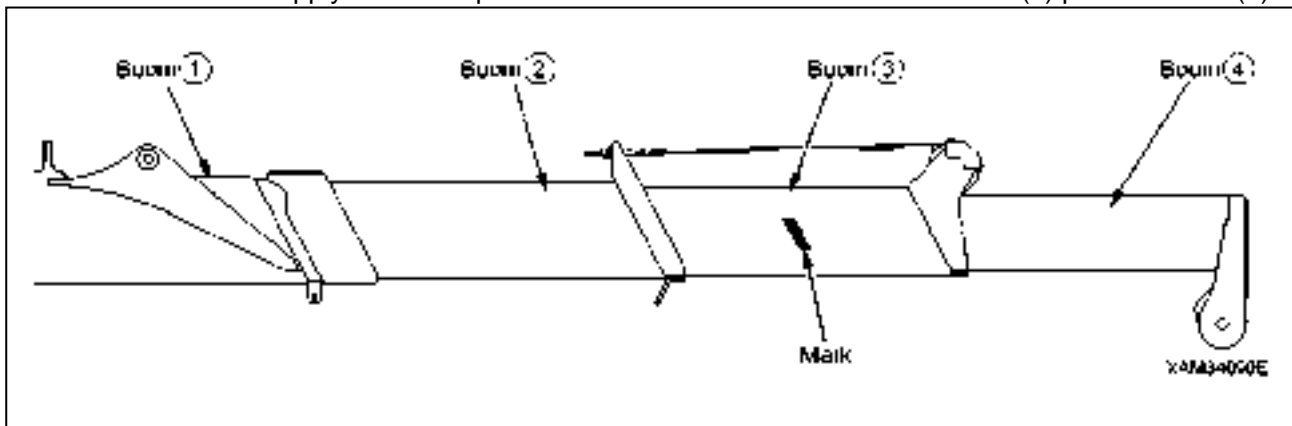

[2] OUTRIGGER MAXIMUM EXTENSION

⚠ WARNING

- Make sure all the outriggers are placed in the correct position before performing crane operation.
It is strictly forbidden to perform any crane operation before you place outriggers.
- Always place the machine in a horizontal position with the use of the level when extending the outriggers. A warning buzzer sounds when the machine is inclined 3° or more and stops when the machine is placed in a horizontal position.
- Where a crane operation in a condition that outriggers are not fully extended is required, see "Rated Total Load Chart with outrigger extended to other than Maximum" of the Rated Total Load Chart. Failure to perform crane operation with proper values may cause the machine to topple over. Exercise caution when performing operation.
- Despite the maximum extension of all the outriggers, the width of extended outriggers decreases due to an ungraded ground even when clearance "a" in the right figure is 50 mm. Crane operation should proceed with respect to the values specified in "When the crane is used with the outriggers extended midway" in the total rated load chart.
- Where any of the outrigger inner box is retracted into the outer box, only "Rated Total Load Chart with outrigger extended to other than Maximum" of the Rated Total Load Chart is applicable for that crane operation, even when it is retracted for the length of 1 position pin span.
- The machine becomes unsteady at some point if it undergoes a 360-degree slewing with an object hoisted. Irrespective of the rated total load, ensure operation is in a short working radius and at low speed.

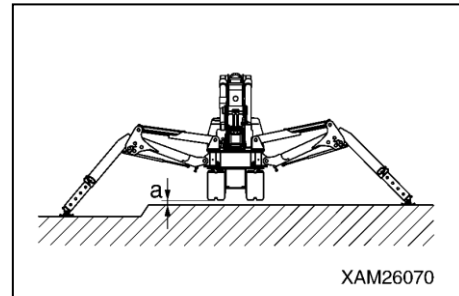

The diagram shown on the right represents the condition "When the crane is used with the outriggers extended at the maximum" in the total rated load chart.

If the inner box is retracted even if only slightly, crane operation should proceed with respect to the values specified in the total rated load chart corresponding to "Rated Total Load Chart with outrigger extended to other than Maximum".

See "OPERATION 2.13 OUTRIGGER SET UP OPERATION" for proper setting of the outriggers.

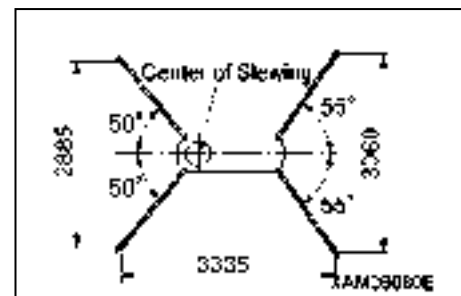

NOTES

Outrigger maximum extension is defined as that:

1. The outrigger is set at the positioning pin position (55 degrees front, 50 degrees back).
2. The inner box of all the outriggers is extended fully.
3. All the outriggers are placed on a level surface.
4. Approx. 50mm is assured for clearance "a" (between the outrigger bottom and crawler bottom) as shown in the figure to the right.

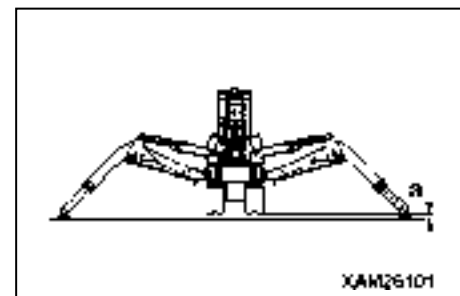

[Placement of outrigger position pins when "outriggers are extended to maximum".]

Figures below shows the placement of outrigger position pins (12) in a condition that "outriggers are extended to maximum"

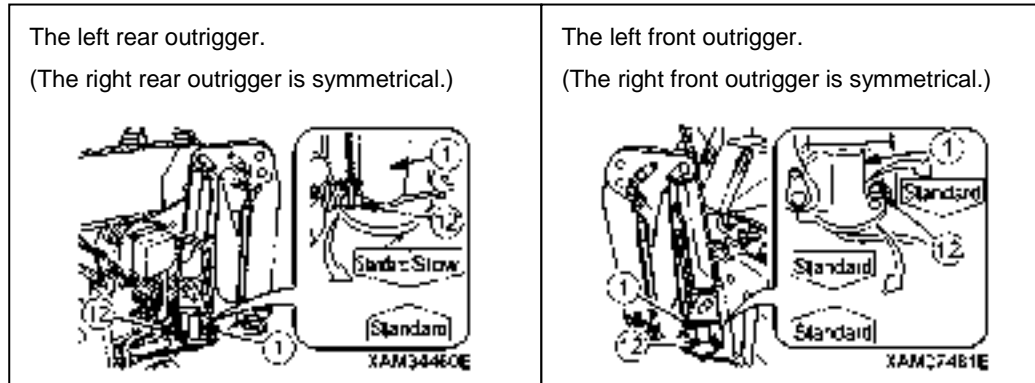

5.4 ANGLE INDICATOR

⚠ WARNING

- Use the Boom angle indicator to check the angle of the boom in operation when the crane is operated from a distance; using a remote-controller, for instance.
- Before hoisting a load, always see the Rated Total Load Chart to determine the correct boom length (i.e. number of boom boxes used) and angle, then check the actual weight of the load with the applicable rated total load and ensure that weight of both of the load itself and sling utensils never exceeds the rated total load. The Boom angle indicator is helpful to confirm the boom angle, then,

The Boom angle indicators are attached to both left and right sides of the No.1 Boom. The indicator consists of a scale plate and a pointer as shown in the figure on the right.

Use boom angle indicators as follows:

- Read the figure which the pointer indicates.
The figure shows the "Boom angle" of the moment.

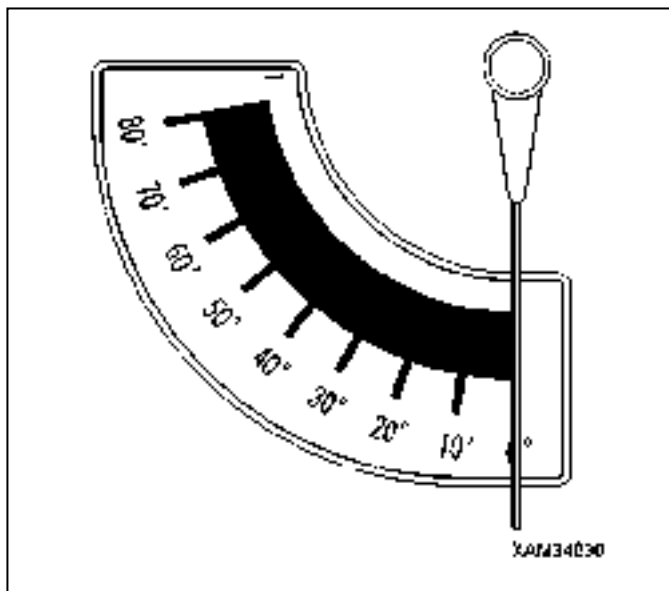

SAFETY

1. BASIC PRECAUTIONS	2- 2
2. DRIVING RELATED PRECAUTIONS	2- 7
3. TRANSPORT PRECAUTIONS	2-21
4. BATTERY HANDLING PRECAUTIONS	2-23
5. MAINTENANCE PRECAUTIONS	2-25
6. SAFETY LABEL LOCATIONS	2-32
7. WEEE DIRECTIVE LABEL LOCATIONS	2-39

WARNING

All the safety precautions defined in this manual should always be read and observed.

Failure to follow the safety precautions can cause serious personal injury or death.

1. BASIC PRECAUTIONS

OBSERVE THE MANUAL AND SAFETY LABELS

- Read thoroughly and understand this manual as well as the safety labels on various part of this Machine. Attempting to drive/operate without understanding fully may result in wrong operation that may cause personal or equipment accidents.
- Fully understand the proper use and inspection/maintenance procedures, and exercise safe working.
- Make sure this manual and the safety labels labeled on various part of this Machine are legible all the time. Whenever illegibility or loss occurs, contact us or our sales service agency to put the safety label back to the original location.



DRIVING LICENSE

- **Full training or a License** are necessary to drive this Machine. Always obtain training or a license before driving.
★ See "Introduction 4. Qualification for Operation" for details
- Drivers are requested to receive education and training of the handling methods and other subjects from the applicable office, and obtain sufficient driving operation skill before work.

WEAR PROTECTIVE EQUIPMENT AND CLOTHES SUITABLE FOR WORK

- Always put on a helmet, safety shoes and safety belt.
- Select and make sure to put on necessary protective equipment suitable for the relevant working condition.
- Do not wear loose garments or accessories that may catch operation levers or protrusions and cause unexpected movement of the Machine.



COMMIT TO SAFE OPERATION

- Obey the instructions and signs given by the manager and work supervisor, and observe safety first during the work.
- Obey the crane work basics during work.
- Before starting driving or work, always carry out the inspections.
- Do not work in bad weather for instance strong wind, thunder or mist.
- Do not drive under any circumstances when you are overtired, under the influence of alcohol or after taking a somnific drug.
- Obey all of the workplace rules, safety regulations and operation method sequences during driving operations and inspection/maintenance.
- Pay attention to the surrounding conditions and pedestrians all the time when driving or working. Whenever a pedestrian approaches without taking due care, stop working straight away, and take a measure such as issuing a warning.
- When driving, be mentally prepared for any unexpected situation and so that you can take measures immediately.
- Do not attempt any use out of the capabilities and purposes described in this manual under any circumstance.
- Observe the designated rated total load and work range when driving.
- Do not attempt inattentive driving, harsh driving or awkward operation under any circumstances.
- Remove the key when leaving the machine.

USE OF MACHINE THAT WAS RENTED OR PREVIOUSLY USED BY SOMEONE ELSE

Check the following subjects in writing before using any Machine that was rented or previously used by someone else.

In addition, check the inspection record table for the maintenance conditions such as the periodic inspections.

- (1) Crane capacity
- (2) Crane maintenance condition
- (3) Behavior and disadvantage unique to the crane
- (4) Other subjects that require attention when driving
 - (a) Operating condition of the brakes, crutches etc.
 - (b) Presence/absence and lighting condition. Checkup of lighting and rotating lamps
 - (c) Operation condition of hook, winches, boom, outriggers and related items

CHECK SAFETY DEVICES

- Check that all guards and covers are attached properly. Repair immediately if damaged.
- Understand how to use the safety devices well and use properly.
- Do not detach any safety device under any circumstances. Keep control to achieve proper function all the time.
- Improper use of safety device may lead to serious bodily accidents.
- Do not trust safety device too much during operation.

FOLLOW INSTRUCTIONS AND SIGNS WHEN WORKING

- When working with the crane, appoint a work supervisor and agree mutual signs beforehand, and follow the work supervisor and signs during work.
- When working at a location where many areas are out of view from the driver, be especially careful to follow the instructions and signs of the work supervisor and pay attention when driving.
- When working with the crane, the clearance between the boom and the travelling dolly and also the gaps between the movable parts of the derrick cylinder may catch body parts such as an arm or finger. The driver is requested to make sure no one is within the working radius of the crane before operating the crane.

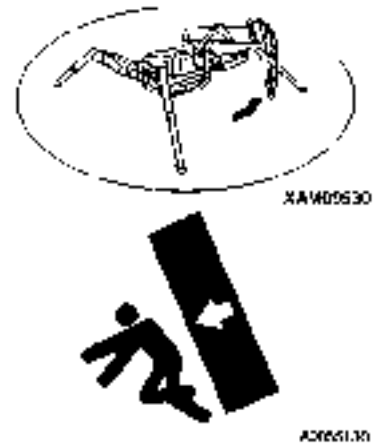

PREPARE FOR ABNORMALITY

- Carry out secure inspections and services to prevent accidents.
- Whenever you feel abnormality of the Machine, abort working immediately, ensure safety and report to the manager.
- Assign in advance who takes which solution to prevent a secondary accident.
- Do not drive the Machine when fuel or hydraulic oil is leaking from the Machine. Report to the manager the abnormality, and fully repair the fuel/hydraulic oil problem before use.

This machine uses gasoline/LPG as its fuel. Pay particular attention to any fuel leakage.
- Before leaving the Machine, lower the hoisted load to the ground, stop the engine and remove the engine key.



TEMPORARY STORAGE WHEN ABNORMALITY IS FOUND WITH MACHINE

In case the Machine is found with an abnormality and is therefore stored temporarily waiting for service, apply following measures to notify all people in the office that its use is prohibited due to failure.

- Indicate warning tags on the crane operation lever and other applicable parts.

Write clearly the information such as abnormality contents, name and contact of the storage manager, and the term of storage.

- Keep immobile when parked by putting blocks on the rubber tracks as pawls.
- Remove the engine key and take it with you.

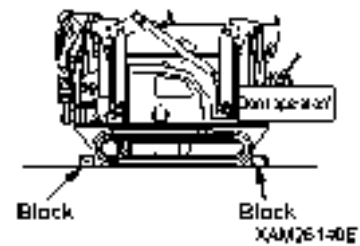

PROVISION OF FIRE EXTINGUISHER AND FIRST AID BOX

Always observe followings to prepare for injuries and fires.

- To prepare for fires, decide the fire extinguisher storage location and install one, fully read the attached label for the usage and be prepared for fighting emergencies.
- Decide the location to store the first aid box. In addition, inspect the first aid box periodically and replenish the contents as necessary.
- Decide the measures to take upon an injury or fire accident.
- Decide how to contact the emergency address (for instance the emergency physician, ambulance or fire department), and show the contact address at designated position so any person can make the contact.

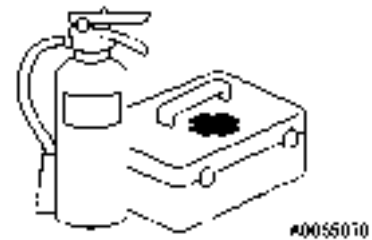

DO NOT RUSH AND BE CAREFUL WHEN WORKING

- Do not attempt sudden lever operation or harsh driving.
- When two or more cranes work close to each other, drive carefully while paying attention to accidents such as trips caused by contacting each other. Also, appoint a guide if necessary for increased prevention of contact accidents.
- When abnormality or danger occurs during work, abort working immediately to avoid hazard.
- Stop work under in bad weather conditions (heavy rain, strong wind, thunder, thick fog).

Decide when to abort working by seeing the "work abort decision standard" in the work schedule and by discretion of the work supervisor of the site.

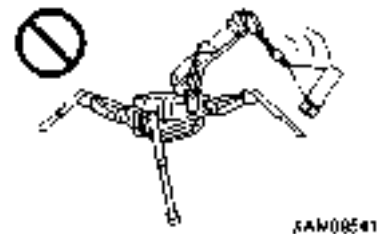

DO NOT MODIFY

Do not modify the Machine without our written consent under any circumstance.

The modification raises a safety issue, so consult us or our sales service agency beforehand.

We cannot be held responsible for any bodily accident or failure caused by modification that was performed without consulting us.

SAFETY WHEN REFILLING FUEL

- This machine operates using gasoline/LPG.
Do not refill with the wrong kind of fuel.
Refilling with the wrong fuel may damage the engine.
- Always stop the engine before refilling fuel.
Refilling the fuel when engine is driving may cause leaked fuel to catch fire from hot muffler or other related parts.
- Oversupply of fuel results in spilling and is dangerous. Refill slightly lower than the specified level.
Always wipe away cleanly whenever the fuel spills.
- Securely close the tank cap after replenishing fuel.



A0055023



A0055040

KEEP FIRE AWAY FROM OIL

- Attempt to let a fire approach the fuel, hydraulic oil or engine oil may result in catching fire. Strictly observe the followings.
- Do not let any fire such as a cigarettes or matches near the combustibles.
 - Securely close all of the fuel and oil container caps.
 - Keep the fuel and oils in well-ventilated location.
 - Store the fuel and oils in a fixed location and keep unauthorized persons away.
 - Do not leave the site when replenishing the fuel or oil.
Be especially careful to observe "Safety when refilling fuel" described earlier when replenishing fuel.
 - Cleanly wipe away any fuel or oil spilled during replenishment.



A0055023



A0055040

HANDLING IN HIGH TEMPERATURE

- For a short time after ceasing operation of the Machine, the engine itself and engine oil, cooling water and hydraulic oil will have a high temperature, and in addition the pressure is accumulated inside the hydraulic oil tank.
- Any attempt to inspect the engine, remove the radiator cap, drain oil, drain water or replace the filter under such condition may result in burns.
- Wait until the temperature cools, then carry out the following procedure.
1. To prevent emission of the high temperature oil, stop the engine and wait until the oil temperature drops.
 2. Loosen the bolts so that the cap is raised a little to allow the release of inner pressure.
 3. Remove bolts and then remove cap.
(To find how much the oil temperature dropped, hold your hand near the surface of the hydraulic oil tank or similar location without actually contacting and find out from the ambient temperature.)



A0355050

BEWARE OF ASBESTOS DUST

Inhalation of air containing asbestos may result in lung cancer. This Machine does not use any asbestos, but asbestos may be contained in the wall, ceiling or other part of construction within the work area of this Machine. In addition, be careful of the followings when working with a material that may be using asbestos.

- Put on designated dust free mask and/or other equipment as necessary.
- Do not use compressed air for cleaning.
- Spray water when cleaning to prevent asbestos dusts from flying into air.
- Always work downwind when driving the Machine at a site that may contain asbestos dusts.
- Strictly observe the assigned rules related to the working site and environmental standard.



A0065040

CRANE INJURY PREVENTION

Do not let whole or part of your body enter any of the following clearances, since such act may cause serious bodily accidents.

- Between the boom and the travelling dolly.
- Between the outrigger support and the ground contact surface.
- Between the boom/post and the derrick cylinder.
- Between the winch drum and the wire ropes.
- Between sheaves and wire rope.
- Between the crawlers and the ground.



A0065130

BEWARE OF EXHAUST GAS

When starting the engine or handling fuel/cleaning oil/paint indoors or at a location with bad ventilation condition, prevent gas-poisoning risk by improving the ventilation by opening the windows and exits. If the ventilation is insufficient even after opening the windows and exits, set up a ventilation fan.



A0065040

2. DRIVING RELATED PRECAUTIONS

2.1 BEFORE STARTING THE ENGINE

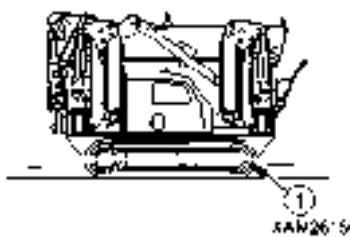
ESTABLISH SAFETY OF THE WORKING SITE	
<ul style="list-style-type: none">• Confirm that no danger is present at the working site before starting work.• Investigate the ground and road surface condition of the working site and decide the best working method.• Flatten the inclination of the working site as much as possible before starting work. Also, if sand and gravel are excessive, hose down before work.• When working over the roadway, place guides or surrounding barriers, to ensure the safety of traffic, vehicles and pedestrians.• Prevent people from entering the working site and apply measures to prevent people from approaching. Attempting to approach a moving Machine may result in hard collision by contact or pinching, and may result in serious bodily accidents and deaths.• When travelling in the water or crossing over shallow water, check the ground condition, depth and water velocity beforehand and make sure not to exceed the allowable water depth (no higher than center of idler (1)). ★ See "Operation 2.12 [2] Allowable Water Depth" for details	 <p>① XAN26-50</p>

INSPECTION BEFORE STARTING ENGINE	
<p>Execute following inspections before the first engine startup of the day. Omitting these inspections may result in serious bodily accidents.</p> <ul style="list-style-type: none">• Inspect for fuel/oil leak, accumulation of combustibles around the engine and battery systems, and similar phenomenon. ★ See "Operation 2.1 Checks Before Operation" for details.• Inspect the fuel quantity, cooling water quantity, hydraulic oil tank quantity, air cleaner blockage, electrical wiring damage, and check operations of safety devices and instruments. ★ See "Operation 2.1 Checks Before Operation" for details.• Make sure the operation levers are at neutral position. Check that the operation linkages operate adequately. Always repair if any result of the above is faulty.	 <p>A0055023</p>

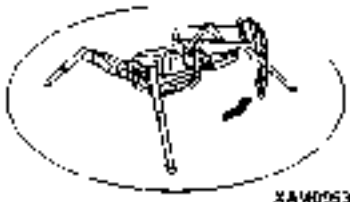
CAUTIONS WHEN STARTING ENGINE	
<ul style="list-style-type: none">• Make sure no person or object is within the boom swing radius area before starting engine.• Blow the horn for warning before starting the engine.• Do not start the engine by short-circuiting the starter circuit. Such actions may cause a fire.	 <p>XAN05530</p>

2.2 AFTER STARTING THE ENGINE

INSPECTION AFTER STARTING THE ENGINE

Omitting the inspections after starting the engine results in delay to notice any machine abnormalities, and may result in bodily accidents and Machine damage.

Inspect a wide area to ensure no obstacles, also ensure people are prevented from approaching the Machine.

- Inspect the equipment operation conditions, Machine travelling conditions, outrigger operation conditions, winch winding up and down, boom derricking, and crane operation conditions such as extension, retraction and swinging.
- Inspect the sound, vibration, heat and odor of the Machine, and check for instrument errors, air leaks, oil leaks, fuel leaks and other bad factors. Be extra careful with fuel leaks.
- Always repair broken part whenever an abnormality is found.
Attempt to use without servicing may result in unexpected bodily accidents and/or Machine failures.

CAUTIONS WHEN STARTING TO MOVE THE MACHINE

To prevent serious injuries and death accidents, always execute the followings before moving the Machine.

- Set the Machine to the travelling position in the right diagram.
Do not travel when the hook block is not contained.
- Ensure the boom is fully lowered and retracted.
- Fix the hook block into the containment position.
- Ensure the outrigger is contained.
- ★ See "Operation 2.5 Machine Travel Position" for details.
- Make sure again that no one or object is in the vicinity before starting to move.
- Blow the horn for warning before starting to move.
- When travelling, be sure to stand in front of the travel lever located on the travel control panel side. When the machine starts moving, walk and keep your pace with the machine speed.
- The Machine is prohibited to travel when a person or load is on the travelling dolly or the boom.
- When travelling, stow hook and outrigger, and make sure of the surrounding safety.
- When stowing outriggers, insert each position pins completely to lock.

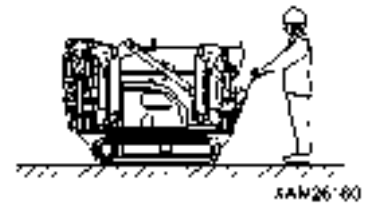

CAUTIONS WHEN MOVING FORWARD/BACKWARD OR CHANGING DIRECTION

Always observe followings to prevent serious injuries and death when moving the Machine.

- Drop the speed early and wait until the Machine stops before changing from forward to backward, or backward to forward.
- Blow the horn and alert the people nearby before changing between forward/backward movements or changing direction.
- Check that no one is around the Machine.
The front of the Machine frame requires special attention because certain areas of vision are blocked, so stop the Machine as necessary and make sure no one is at front or around.
- Place a guide if the location is hazardous or with a bad view.
- Make sure to prevent people from crossing the moving direction or in the direction to be changed.

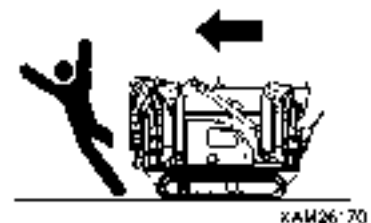

CAUTIONS WHEN TRAVELLING

Always observe the following to prevent serious injuries, fatal accidents when the Machine is travelling.

- Do not attempt looking sideways or other dangerous acts when driving.
- Do not over speed, start moving suddenly, stop suddenly, swing suddenly or meander since such acts are dangerous.
- When travelling backward, the operator should be extremely careful of uneven ground. Lower the speed and drive the machine carefully and take care not to get trapped by bumps or other obstacles.
- Whenever you find a machine abnormality (sound, vibration, odor, instrument error, fuel leak, water leak or oil leak), immediately park the Machine in a safe location and inspect the cause.
- Do not suddenly change the direction. Doing so may cause the Machine to lose balance or damage the machine or nearby objects.
- When travelling over uneven terrain, change travel speed mode to "low speed" to travel as slow as possible to prevent tripping, and avoid acute operation when changing the direction.
- Avoid moving over obstacles as much as possible.
Change travel speed mode to "low speed" and travel as slowly as possible when moving over an obstacle for unavoidable reason. Also, do not move diagonally over obstacles that cause the Machine to tilt excessively (10 degrees or more).
- When travelling, ensure extra clearance to prevent accidental contact with other machinery or objects.
- When travelling in water or crossing over shallow water, check the ground condition, depth and water velocity (never attempt to enter into flowing water) beforehand and make sure not to exceed the allowable water depth (no higher than center of idler (1)).
★ See "Operation 2.12 [2] Allowable Water Depth" for details.
- Check weight limits against the Machine mass before crossing over a bridge or construction that is private property. In case of public road, ask the applicable road management administration and follow the given advice.
- Do Not travel with load hoisted.

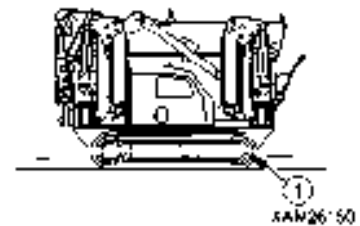
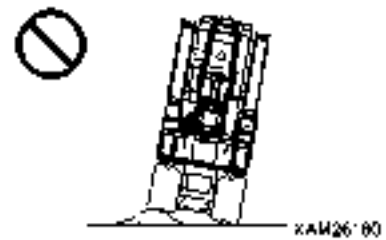
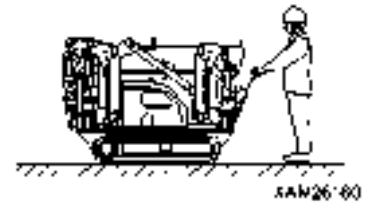

BE CAREFUL WHEN TRAVELLING OVER SLOPES

ALWAYS observe followings to prevent serious injuries, death or accidents when travelling over a slope for unavoidable reason.

- Be careful of tripping and skids when travelling over slope.
- Do not change orientation on or horizontally when travelling over slope. Practice safe travelling by for instance lowering to the flat land and divert.
- ★ See "Operation 2.12 [3] Cautions on Upward/downward slope" for details.
- Skids happen more than you think on grass, fallen leaves, and on wet steel plates.
Avoid the Machine from being horizontal over the slope as much as possible, and decrease the speed sufficiently.
- Travel slowly in low speed when travelling downhill, after changing travel speed mode to "low speed". In addition, apply brake (by setting the travel lever to neutral) as necessary.

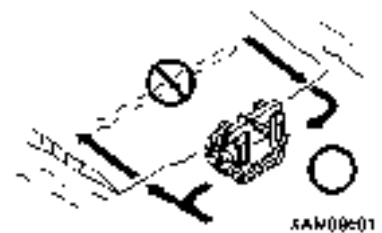
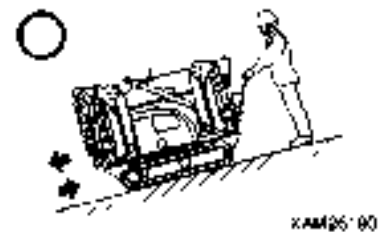

BE CAREFUL OF TRIPPING ON UNSTABLE GROUND

Always observe the following to prevent serious injuries and fatal accidents when travelling over unstable ground for unavoidable reason.

- Do not enter soft ground area. The Machine is difficult to evacuate from such area.
- The ground near cliff, roadside and deep gully is unstable, so avoid going near such ground as much as possible.
The Machine may trip or fall when the ground loosens due to mass and/or vibration of the Machine. Be especially careful that the ground is likely to loosen after rain, use of dynamite or earthquake.
- Avoid going near the earth fills or dug gutters that are unstable.
Crumbles caused by mass and/or vibration of the Machine may cause the Machine to tilt.

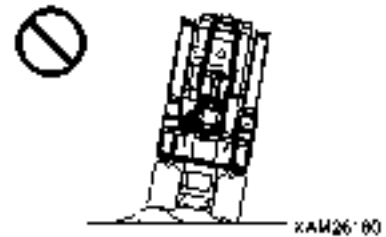

CAUTIONS WHEN THE GROUND IS COVERED IN SNOW OR FROZEN

Always observe the following to prevent serious injuries and fatal accidents when travelling over a snow covered ground or frozen road for unavoidable reason.

- The snow covered ground and frozen roads cause slips even when the inclination is small, so decrease the speed when travelling and avoid starting suddenly, stopping suddenly and swinging suddenly. Uphill and downhill are especially likely to cause slips and thus dangerous.
- Ground of the frozen road becomes soft when the air temperature rises and causes the machine travel and other operations to be unstable. Be very careful.
- Under cold weather, check that the load to be hoisted is not frozen, stuck to the ground or any other surface. Attempting to hoist without knowing the load is frozen, stuck to the ground or any other surface is dangerous.
- Do not directly contact metal surface with your body part such as a finger or hand under cold weather.
Attempt to contact the metal surface of the Machine under harsh cold weather may cause the skin to stick to the frozen surface.
- Remove snow and/or ice laid on the Machine that causes the safety nameplates to be hard to read. Be especially careful to securely remove those that are on the boom and thus may fall.

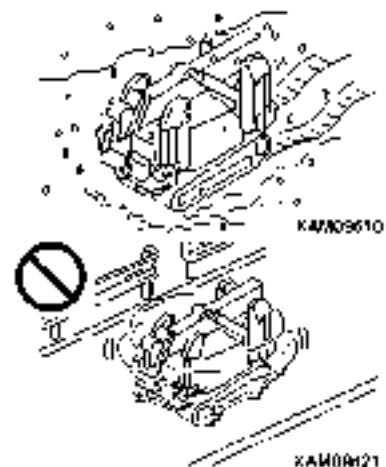

CAUTIONS WHEN PARKING

- Park at a location where the ground is level, rock falls and landslides do not occur, if it is a lowland check that flooding does not occur.
- If you must park on a slope for an unavoidable reason, use blocks as pawls to immobilize the Machine.
- When parking on the street, place flags, protection barriers, lighting and caution notices that do not interfere with the traffic, so that other vehicles are aware.
- Stop the engine before leaving the Machine.
Always remove the starter key and store in a fixed location.
- When parking, the lock lever must be placed to "Lock".

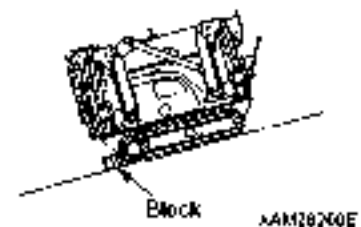

PRECAUTIONS IN COLD WEATHER

- Remove snow from and defreeze the swing gear, boom and winch related parts, and check the movements before work.
- Warm up thoroughly.
Attempting to operate the operation levers and switches without enough warm-up will cause the Machine to be slow in reaction, and may result in unexpected accidents.
- Avoid acutely accelerating the engine shortly after starting the engine.
- Increase the oil temperature of the hydraulic circuit by relieving the oil pressure (let the pneumatic oil escape to the hydraulic oil tank by raising it above the hydraulic circuit set pressure) by using operation lever. Doing so improves the Machine reactions and prevents improper operations.
- If the battery fluid is frozen, do not charge battery or start the engine using other power source.
Such acts may cause the battery to catch fire.
Before charging or starting up using other power source, defreeze the battery fluid and check that failures such as battery fluid leak do not exist.
- After end of the work, wipe off and apply wraps if substances such as condensation, snow or mud are stuck to the wire harness, connector (1), switches, sensors or similar part.
If the infiltrated condensation and/or similar substance freezes, the Machine may not operate properly upon the next use and cause unexpected accidents.

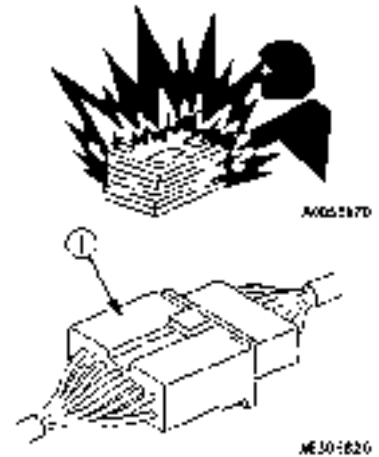

2.3 WORKING WITH THE CRANE

INSPECTION BEFORE STARTING WORK

Check that the safety devices and crane operate properly.

- Operate each of the operation levers and switches under no load, and check operations are performed normally.
Repair immediately if any abnormality exists.
- Check that the safety devices such as the moment limiter, and over hoist detector device activate properly.

CAUTIONS WHEN HANDLING MOMENT LIMITER

- Use/store the moment limiter under the following ranges of ambient temperature.
★ Temperature of use: 10 to 50 °C Storage temperature: -20 to 60 °C
- Avoid direct sunlight so that the temperature of the moment limiter body does not exceed the range.
- Avoid locations with strong acid or alkaline atmosphere as much as possible. Otherwise, unexpected failures may occur.
- Do not apply impact to the moment limiter body for instance by colliding with an object.
Such attempt may damage the case and may result in failures and improper operations.
- Do not push the panel sheet of the moment limiter body by a force more than necessary or push with sharp object such as a tip of a screwdriver. Such action may damage the panel sheet and may result in failures and improper operations.
- Do not remove the case cover or panel sheet from, or disassemble the moment limiter body. Such action may damage the case and/or panel sheet and may result in failures and improper operations.

CAUTIONS WHEN SETTING UP MOMENT LIMITER

- The moment limiter calculates the moments assuming the Machine is level.
If you work with the crane when the Machine is not level, warnings and alarms are not issued even when the rated total load is near.
Always set the outrigger horizontally to the ground while looking at the level gauge.
- Before using the crane, check that the boom angle display, boom length display and real load display of the moment limiter are displayed correctly following the crane movements. Attempting to use without the correct display results in failure to obtain correct measurement result and may result in serious bodily accidents caused by improper operation and/or breakage of nearby equipment.
- Always make sure the wire strand setting of the moment limiter matches with the wire strand of the crane. If the wire strands do not match, always let the wire strands match by changing the wire strand setting of the moment limiter or by changing the wire strand of the crane. Attempting to use with unmatched wire strands results in failure to obtain correct measurement result and may result in serious bodily accidents caused by improper operation and/or breakage of nearby equipment.
- Do not carelessly change the setting when measuring with the moment limiter. Such action results in failure to obtain correct measurement result and may result in serious bodily accidents caused by improper operation and/or breakage of nearby equipment.

PLACE CRANE ON LEVEL AND HARD GROUND

- Always place the outriggers on a level, stable and solid ground.
Attempt to work with crane without outriggers firmly contacting the ground may cause the Machine to trip.
- Always place all outriggers before working with crane.
- Do not set any outrigger near the location that may collapse, for instance, soft ground, roadside or drilled hole.
In case the outriggers need to be placed on soft ground for an unavoidable reason, always reinforce the ground by laying a sufficiently large and strong base plate below each of the outrigger supports.

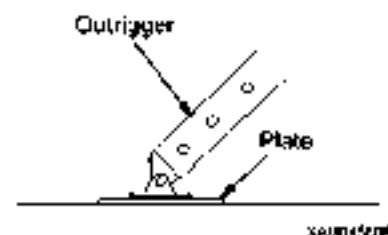

CHECK OUTRIGGER PLACEMENT CONDITION

Always observe followings to prevent serious injuries and fatal accidents when placing the outriggers.

- When placing the outriggers, always keep the Machine level while looking at the level gauge. Occasionally view the level gauge and make sure to keep the Machine level during the crane works as well.
- Place the outriggers at a maximum extension condition as the basic rule.

In case of placing in a non-maximum extension condition for unavoidable reason, always find the values outrigger extended to other than maximum value in the total rated load chart before work.

- Place the outriggers so that the rubber tracks are approximately 50 mm above the ground.
- Make sure all of the outrigger position pins are securely fixed.

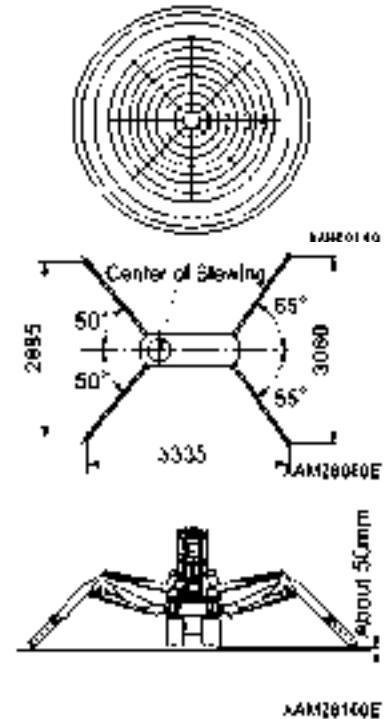

CAUTIONS WHEN PLACING THE OUTRIGGERS

Do not let people approach nearby when placing the outriggers. Otherwise serious accidents, for instance the outrigger support catching a foot, may occur.



BEWARE OF ELECTRICAL CABLE ABOVE

- Do not let the Machine come into contact with overhead electrical cables.
High voltage cables may inflict electrical shock just by being near to them.
- People who throw objects are likely to suffer electrical shocks.
Always observe following to prevent accidents.
- If the boom or the wire ropes may come into contact with an electrical cable in the workplace, consult the electricity company and make sure that the measures (for instance security personnel or the application of wrap tubes and warning tags to the electrical cable) stipulated by the related regulations are taken before starting work.
- Wear rubber soled shoes and rubber gloves, and be careful that the body parts unprotected by rubber or other insulation do not come into contact with the wire rope or the Machine frame.
- Place a guide and let him/her watch so that the boom, wire rope or Machine frame does not get too near to the electrical cable.
Before beginning work, decide on the emergency signs and other necessities.
- Ask the electricity company for the voltage in the electrical cables in the working site.
- Ensure the offset distances (safe distance) shown in the following table between the boom/Machine frame and electrical cables.

	Voltage of Electrical Cable	Minimum Safe Distance
Low voltage (Distribution line)	100-200V	2m
	6,600V	2m
Special (Transmission line)	22,000V	3m
	66,000V	4m
	154,000V	5m
	187,000V	6m
	275,000V	7m
	500,000V	11m

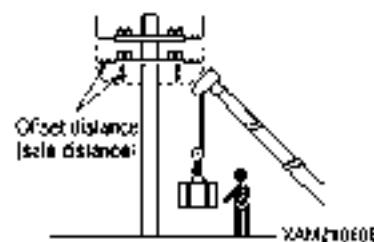
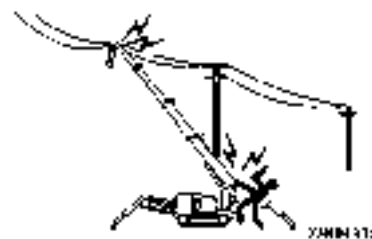

MEASURES WHEN CHARGE ACCIDENT OCCURS

When an electrical charge accident occurs do not panic and follow the steps below:

1. Report

Immediately report to the electricity company or related management company, and receive instructions on how to stop the power transmission, emergency procedures and any other steps.

2. Evacuation of related personnel from vicinity of Machine

Remove related personnel from around the Machine to prevent secondary disasters.

Personnel who suffered electrical shock by holding a sling rope, guide rope or other conductor when the Machine was charged should evacuate by his/her own effort.

Do not try to help such person. Otherwise, secondary electrical shock accident occurs.

3. Emergency procedure

Take the solution by following sequence in case of urgency where personnel received electrical shock because the Machine was charged.

(1) If the Machine can be operated, immediately operate the Machine to move the Machine constructions away from the contact and out of the range of the cause of the charge. Be careful not to touch the distribution power cable.

(2) Evacuate the Machine completely away from the cause of the charge, make sure the Machine is not charged, rescue the electrically shocked personnel and immediately transport them to the hospital.

4. Measure after accident

After accident, do not reuse as is. Such attempt may cause unexpected accidents and enhances failures.

Ask us or our sales service agency for repair.

CAUTIONS WHEN WORKING WITH CRANE IN LOCATION WITH HIGH OUTPUT MICROWAVE EMISSION

Working with the crane near a high output microwave emission equipment such as a radar or TV/radio broadcast antenna causes the crane construction to be exposed to the microwave and generates induced current, therefore is very dangerous. In addition, the mechatronics may become haywire.

Establish grounding between the Machine frame and the ground when working in such location. In addition, slingers are requested to wear rubber boots and rubber gloves since risk of electrical shock by contacting parts such as the hook or wire exists.

PAY ATTENTION TO WEATHER INFORMATION

- In case of thunderstorm, there is a risk of lightning, so abort working with crane, immediately lower the load and contain the boom.
- Exposing the hoisted load to wind causes the load to move and causes the Machine to be unstable, thus is dangerous. Immediately lower the load and contain the boom when the wind is causing the load to move.
- If the maximum instantaneous wind speed is 10 m/s or greater, abort working with crane, immediately lower the load and contain the boom.
- Even when the maximum instantaneous wind speed is below 10 m/s, the bigger the hoisted load, higher the hoisted load position, and longer the boom, the wind effect increases accordingly. Be fully careful during work.
- When a load such as a steel plate that has a large area exposed to wind is being hoisted, the wind arriving from front/rear/side of the boom may cause the Machine to trip or damage the boom. Be fully careful when working.
- When an earthquake occurs, abort working and wait until the earthquake is over.
- ★ The following table indicates approximate relation between the wind speed and wind effect. The wind speed mentioned in the weathercast is mean wind velocity (m/s) during 10 m at 10 m above the ground.

Force	Wind Speed (m/s)	Effect On Land
0	Less than 0.3	Smoke rises vertically.
1	0.3 - below 1.6	Wind motion visible in smoke.
2	1.6 - below 3.4	Wind felt on exposed skin.
3	3.4 - below 5.5	Leaves and smaller twigs in constant motion.
4	5.5 - below 8.0	Dust and loose paper raised. Small branches begin to move.
5	8.0 - below 10.8	Smaller trees sway. Some foam and spray.
6	10.8 - below 13.9	Large branches in motion. Whistling heard in overhead wires. Umbrella use becomes difficult.
7	13.9 - below 17.2	Whole trees in motion. Effort needed to walk against the wind.
8	17.2 - below 20.8	Twigs broken from trees. Progress impeded.
9	20.8 - below 24.5	Light structure damage. Slates blown off.
10	24.5 - below 28.5	Trees uprooted. Considerable structural damage.
11	28.5 - below 32.7	Widespread structural damage.

CAUTIONS WHEN SLINGING

- Check the following before hoisting a load.
Attempt to hoist the load without checking may result in serious bodily accidents by a drop of the load or tripping.
- Observe the values in the total rated load chart.
- Hoist from the center of gravity of the load.
- Check that the wire ropes of the hook block are perpendicular to the ground.
- When the load leaves the ground, stop winding up the load once and check whether the load is stable.
- Before hoisting a slung load, always check whether the sling wire rope "retainer device" of the hook block is hung securely. If the "retainer device" is not hung, the wire rope may leave the hook block and cause the load to fall and results in a serious accident.
- Larger wire rope angle when hoisting the load increases force that applies to the wire rope even when the load weight is unchanged, thus may cause the wire rope to snap. Pay consideration when slinging to prevent excessive force being applied to the wire rope.
- Do not hoist more than one load at once.
Such attempt may cause the hoist bracket to hit and damage the other hoisted load, the loads to move and loose balance and fall or cause other serious accidents.
Do not hoist more than one load even if the total is within the rated total load.
- Hoisting of lengthy load causes the load to lose balance and is dangerous.
In case such load, hoist vertically by using a clamp, or achieve balance of the hoisted load by applying a rope to both ends of the load.

CAUTIONS WHEN HANDLING WIRE ROPE

- The wire rope wears out over time, so inspect before each job, and replace immediately if at or beyond the replacement standard.
At the same time, inspect the sheave at the tip of the boom and the sheave of the hook block. Damaged sheaves accelerate the damage of the wire ropes.
- Use the wire ropes specified by us.
- Always put on leather gloves when handling the wire rope.
- Handling worn and damaged wire may cause injury by wire splinter.
- Do not use any wire rope of which any of the followings apply.
 - 10% or more of the wires (except the filler wires) in one twist of the wire rope are snapped.
 - The wire rope diameter abrasion is beyond 7% of the nominal diameter.
 - Is kinked.
 - Is excessively deformed or corroded.
 - Affected by heat or sparks.

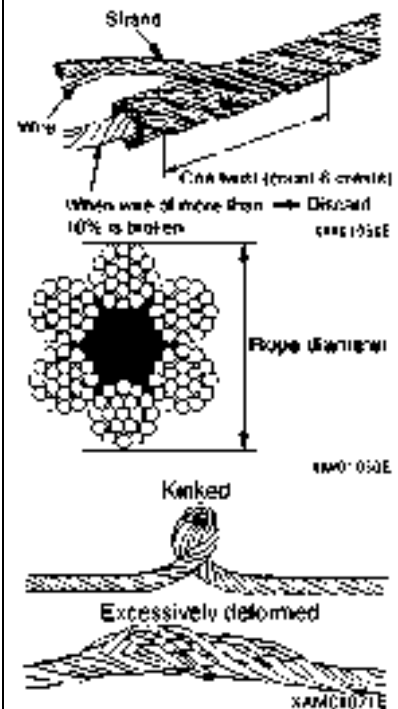

CAUTIONS WHEN WORKING WITH THE CRANE

- Be sure to verify that the emergency stop cancel switch is at OFF (auto) position before operating the crane.
Do not attempt the crane operation when the emergency stop cancel switch is at ON (cancel) position. The emergency stop cancel switch is permitted to be at ON (cancel) position only during the inspection or maintenance works.
- Attempting to work beyond the capacity of the Machine may cause serious accidents and failures caused by for instance tripping or fluctuation. Observe the total rated load chart when working with the crane.
- Do not travel with a load being hoisted under any circumstance.
Such attempt may cause the crane to tip and may result in serious bodily accidents.
- Be slow when operating the crane.
Sudden lever or accelerator operations may cause risks such as the load moving, falling or colliding with nearby objects. Be especially careful to be slow during the swing operations.
- Do not let people approach the work radius or below the load, since risks such as fall of the load and contact with the load exist. Such attempt may result in serious bodily accidents. Also, during the work, consider the fact that the working radius increases when the load is hoisted and the boom is deflected.
- Attempting to work with the crane even when the view is bad due to location or weather is dangerous. Ensure brightness by posting a work lamp or other illumination facility in dark places.
When the view is bad because of bad weather (rain, fog, snow), abort working and wait until the weather recovers.
- Do not use for any other purpose than indicated, for instance raising a person using a crane.
- If the overwinding detector alarm buzzer is heard, immediately remove your hand from the winch lever. The hook block winding stops. Then, operate the winch lever to Down (push forward) to wind down the hook block. In addition, the hook block is wound up when the boom is extended, so be sure to ensure extra clearance between the boom and the hook block during work.
- When the boom extends, the hook block is wound up.
Operate the winch lever to Down (push forward) to wind down the hook block while you extend the boom.
- Whenever an overload occurs during work, lower the load by winding down the winch by setting the winch lever to Down (push forward).
Do not raise or lower the boom suddenly. Such an attempt may cause serious accidents by tripping.
- The volume of the hydraulic oil in each of the cylinders changes depending on the temperature.
By leaving idle with a load being hoisted, as the time passes by the oil temperature drops and the hydraulic oil volume decreases, and changes may occur such as the boom derrick angle decreasing and the boom length decreasing.
In this case, stop boom derricking operations and boom extension operations in order to correct.
- Do not leave the driving operation position when a load is hoisted.
Lower the load before leaving the Machine.
- Keep the hook block wound up when not in use.
Otherwise, anyone near the load may collide with the hook block.
- Operator must not leave operators seat during operation.

CAUTIONS WHEN OPERATING WINCH

- Do not allow anyone below the hoisted load.
- When hoisting a load, always stop at the "takeoff" position where the hoisted load leaves the ground. Check subjects such as load stability and load force, then hoist up the load.
- Do not pull laterally, pull toward you or hoist diagonally. Such attempt may cause the crane to trip or suffer damage.
- Overwinding of the hook block may result in collision with the boom, snipping the wire ropes and causes the hook block and load to fall and cause serious accidents. Be extra careful to prevent overwinding of the hook block.
- Be careful to prevent the wire rope and/or hoisted load from contacting an obstacle such as a tree or steel structure when hoisting a load.

If caught by an obstacle, do not forcibly wind up the hoist load, but untangle the caught part before winding up.

- Do not operate the winch system if the rope is badly wound on the winch drum (tangled). If tangled the rope may be damaged, shortening its life span, and there is a possibility that it may break and cause a serious accident. Observe the following precautions to avoid the rope becoming tangled:
 - Do not let the hook block hit the ground.
 - Before leaving the hook block lowered for a long time for instance when working with underground, leave at least three loops of wire rope in the winch drum.
- If the wire rope is twisted and causes the hook block to turn, fully eliminate the twist before work.

★ See "Operation 4. What to do with Twisted Winch Wire Rope" for details.

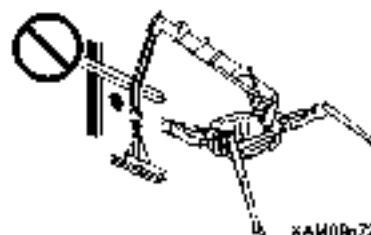

CAUTIONS WHEN OPERATING THE BOOM

- Operate the boom operation lever as slowly as possible. Especially avoid sudden lever operations when the load is hoisted, which may cause the load to move and give large impact to the Machine, and thus may damage the crane or trip the Machine.
- When the boom is lowered, the working radius increases, and the rated total load that can be hoisted decreases. When working while raising/lowering the boom, pay extra attention to ensure that the mass (weight) of the load at the time the boom is most lowered does not cause overloading.
- Attempts to pull the load laterally or pull to bring forth the load by raising/lowering and/or extracting/retracting operation of the boom are prohibited. Do not attempt under any circumstance.
- Be aware of the hook block windup condition and exercise caution when extending or retracting the boom.
- When the boom is extended, the working radius increases, and the rated total load that can be hoisted decreases. When working with extending/retracting the boom, pay extra attention to ensure that the mass (weight) of the load at the time the boom is most lowered does not cause overloading.

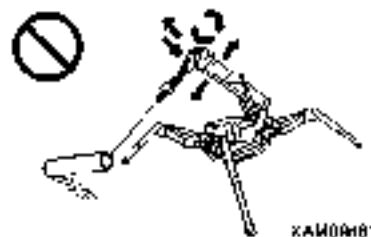

CAUTIONS DURING SWING OPERATION

- Check the safety in the vicinity and blow the horn before swinging.
- If the boom derrick angle is small, be careful to prevent the boom from hitting the driver or the Machine.
- Operate the swing lever as slowly as possible. Make sure to start smoothly, swing slowly, and stop quietly.
Especially avoid sudden lever operations when the load is hoisted, which may cause the load to move and cause the Machine to lose balance, and thus may damage the crane or trip the Machine.
- Attempts to pull to bring forth the load or let the load stand up by swinging operation are prohibited. Do not attempt under any circumstances.
- Be careful to prevent the wire rope and/or hoisted load from contacting an obstacle such as a tree or steel structure when hoisting a load or when swinging.
If caught by an obstacle, do not forcibly wind up the hoist load, but untangle the caught part before winding up.
- Certain outrigger extension condition may cause the boom to hit an outrigger and cause the crane to be damaged or the Machine to trip. Be careful to prevent the boom from hitting outriggers during swing operation.

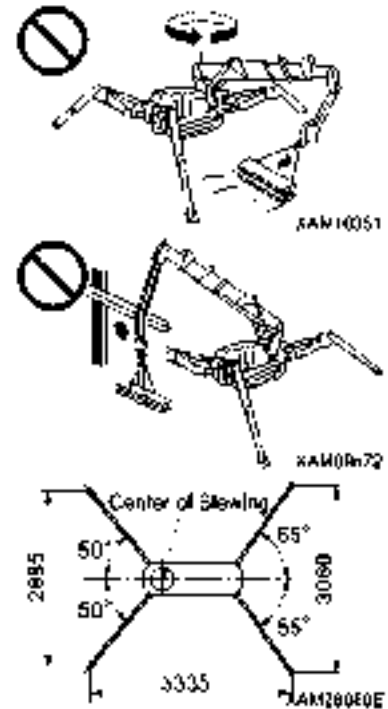

COOPERATION HOISTING IS PROHIBITED AS THE RULE

Cooperation hoisting, that is to use more than one crane to hoist a load, is prohibited.

The cooperation hoisting work is a highly hazardous work that may cause for instance a trip of the Machine due to uneven center of gravity, fall of the hoisted load or boom damage.

If the need for such work is unavoidable, establish a work scheme by responsibility of the user, discuss fully, let the worker fully acknowledge the work method and procedures, then work carefully under the direct leadership of the work supervisor.

Also observe the following cautions:

- Use cranes of same model.
- Choose a Machine model that can handle sufficiently larger loads than the load to be hoisted.
- Make sure only one person gives signs.
- Limit the crane operations to single operations as the rule, and do not attempt any swing operation.
- Appoint one responsible slinger who is most experienced.

WORKING AT A SITE WITH UNDERGROUND LIFTING

- Leave at least three loops of wire rope in the winch drum when winding down the wire rope in case of underground work or similar occasion. This Machine is equipped with three-winding stop alarm / automatic stop device as the safety device, but even then be careful to prevent this safety device from activating.
- Make sure signs are communicated fully.
- Be especially careful with the crane operations.

3. TRANSPORT PRECAUTIONS

CAUTIONS WHEN LOADING OR UNLOADING

- Be especially careful when loading or unloading the Machine because of the risks.
- Select a location that is level and has firm road surface when loading or unloading the Machine. In addition, keep enough distance from the roadside.
- Use ramps underneath with an angle less than 15 degrees. In addition, decide the clearance between ramps to meet the center of the rubber tracks.
- Always set the Machine in the "travelling position" and securely insert the position pins (4 pieces) to the outrigger rotary parts before loading or unloading the Machine.
★ See "Operation 2.5 Machine Travel Position" for details.
- Always move backward when loading the Machine. Moving forward may cause a trip.
- When loading or unloading, set the engine rotation to low idling (low speed rotation) and operate slowly by low speed travels.
- Use ramps that have fully strong width, length and thickness, and that enable safe loading/unloading.
Reinforce with blocks or other substances if the ramps move at all.
- Remove mud and other substances from the footing to prevent the Machine from skidding over the ramps. Remove anything stuck to the ramps such as grease, oil or ice, and keep clean.
Be especially careful in the rain when slips can easily occur.
- Do not change direction over a ramp. Temporarily leave the ramp before correcting the direction.
- Be slow when operating to change the direction on the truck platform where the footing is unstable.
- After loading the Machine, apply the wood blocks so that the Machine does not move, and securely fix with wire ropes or other means.
★ See "Operation 5.1 Loading/unloading" for details.
★ See "Operation 5.3 Cautions in Loading Machine" for details.

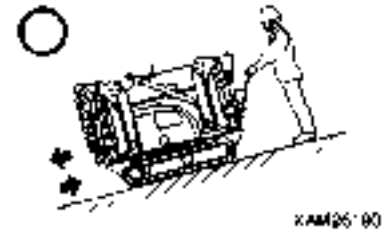
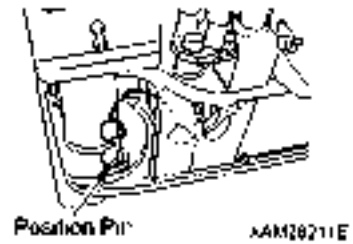
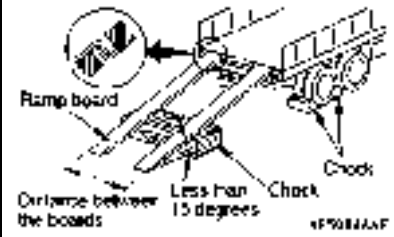

CAUTIONS DURING TRANSPORT

Observe the related regulations and exercise safety during transport.

CAUTIONS WHEN LOADING/UNLOADING WITH A CRANE

Be careful of the following when loading or unloading the Machine by hoisting with a crane.

- When lifting up the Machine, always set it to the stowage position first, and lift from the lifting bracket (A) on the top of the boom. Always use only this bracket and only one sling wire. Any other manner than this, i.e. from other lifting brackets or multiple sling wires, may cause droppage of the machine and result in serious injury or death.

Where there is no choice but the machine has to be hoisted in a different manner, please contact us or service agencies.

- Only use sling utensils (e.g. wire ropes and shackles) which are proved to be capable to the mass (weight) of the machine.
- The crane's stowed posture when it is hoisted means its "travelling position" where 4 of outrigger position pins are securely inserted in the outrigger rotary.

The center of the balance of the machine is specified subject to that the machine is in its travelling position. In addition, to set it into that position correctly, secure the hook block (4) to its stowing position, as well as stretch the wire rope tight which aid to prevent the boom derricking cylinder form extending.

★ See "Operation 2.5 Machine Travel Position" for details.

- When the machine is hoisted in such manner for an extensive time, the boom derricking cylinder may extend which causes the center of the balance of the machine to change and put it out of balance. Thus, hoisting should be limited to within 10 minutes.
- Where it is required to hoist the machine for a longer time (exceeding 10 minutes), or when it is carried by a helicopter, use a proper carriage deck as shown in the diagram on the right, for safe transportation.

★ Recommended hoisting equipment

- Shackle: BC or SC, nominal 14

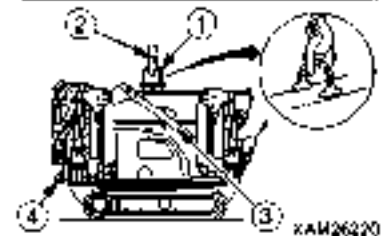
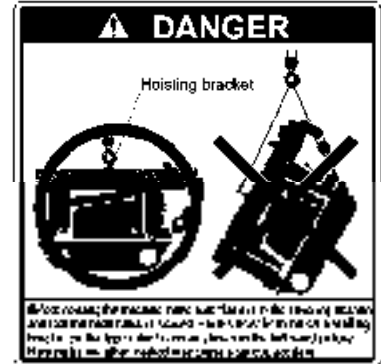
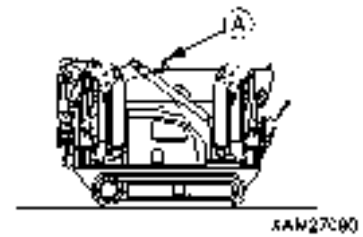

4. BATTERY HANDLING PRECAUTIONS

BATTERY HANDLING PRECAUTIONS

The battery fluid includes diluted sulfuric acid, and generates hydrogen gas, and causes bodily accidents and fires if handle improperly, so always observe the followings.

- Do not let a cigarette or any fire source approach the battery.
- Always put on protective glasses and rubber gloves before handling the battery.
- If the battery fluid has contacted clothing or skin, immediately wash away with a large quantity of water.
- If the battery fluid entered an eye, wash immediately with water and see the doctor as soon as possible.
- If you have swallowed the battery fluid by mistake, immediately drink a large quantity of water, milk, raw egg or vegetable oil, and see the doctor as soon as possible.
- Wipe with a wet clean cloth when cleaning the battery upper surface or related part. Do not use organic solvent or detergent for instance gasoline or paint thinner.
- Tighten the battery cap fully.
- If the battery fluid is frozen, do not charge battery or start the engine using other power source. Such act may cause the battery to catch fire.
- Before charging or starting up using other power source, defreeze the battery fluid and check that failures such as battery fluid leak do not exist.
- Always detach the battery from the Machine frame before charging the battery.



PRECAUTIONS WHEN STARTING UP USING BOOSTER CABLE

Wrong booster cable connection method may result in fire, so always observe the following.

- Start the engine with two people, with one standing on the driving operation position in the travel operation panel side.
- When starting using other Machine, be careful to prevent contact between the normal Machine and broken Machine.
- Keep the starter switch key of both the normal Machine and the broken Machine in OFF position when the booster cable is connected.
- Do not connect to wrong side [connecting (+) to (-), (-) to (+)] when connecting the booster cable.
- Start connecting from (+) terminal first, but start disconnecting from (-) terminal (ground) first.
- Connect the ground to the (-) terminal of the battery of the broken Machine when connecting the ground as the last procedure.
★ See "Operation 8.4 Starting Engine with Booster Cable" for details.
- Avoid the contact between clips of the booster cable, and contact between a clip and the Machine when disconnecting the booster cable.

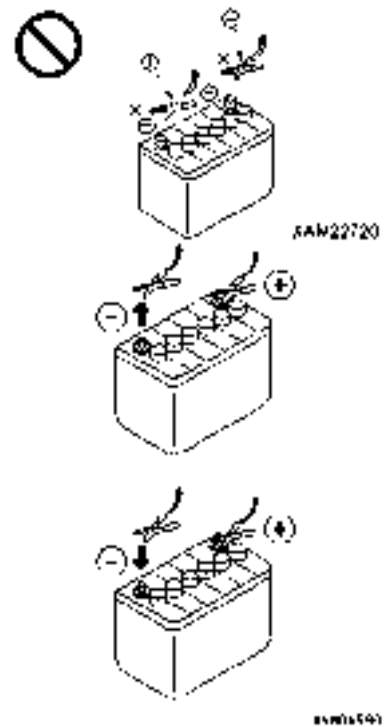

PRECAUTIONS WHEN CHARGING THE BATTERY

Improper handling when charging the battery may cause the battery to explode. Follow the manuals attached to the Machine and the charger, and always observe the followings.

- ★See "Operation 8.3 Cautions in Charging the Battery" for details.
- Carry the charger to a location with good ventilation, then remove the battery cap. Doing so causes the hydrogen gas to disperse and prevents explosion.
- Adjust the charger voltage to suit the voltage of the battery to charge. Mistake in adjusting the voltage may cause explosions due to overheat and ignition of the charger.
- Securely fix the (+) charge clip of the charger to the (+) terminal of the battery, then securely fix the (-) charge clip to (-) terminal of the battery.
- Set the charge current to no more than 1/10 of the rated capacity of the battery, or, in case of quick charge, set to the rated capacity of the battery or smaller.
- Excessive charge current may cause leap fire and explosion caused by fluid leak or fluid deficiency.



5. MAINTENANCE PRECAUTIONS

5.1 PRECAUTIONS BEFORE MAINTENANCE

FAILURE REPORT

Execution of maintenance not described in our manual may cause unexpected failures. Ask us or our sales service agency for repair.

CLEAN BEFORE INSPECTION OR MAINTENANCE

- Before starting an inspection or maintenance, clean the Machine and prevent rubbish from entering the Machine to ensure safety during maintenance.
- Attempting inspection or maintenance with the Machine still dirty not only lessens chance of locating faulty part, but may cause rubbish or mud to get into your eyes, or slipping and tripping that results in injury.
- Always observe followings when washing the vehicle.
 - Use antislip shoes to prevent slips and trips caused by it being wet underfoot.
 - Put on protective equipment when using a high pressure steam car wash. Avoid the accidents that the contact with high pressure water causes the skin laceration or mud or other substance flying into eye.
 - Do not spray water directly onto the electrical system (sensors, connector (1), receiving box and related). Any water in the electrical system causes faulty operations and may trigger improper operations, thus is dangerous.



TIDY UP THE WORKPLACE

In the workplace, put away the tools, hammers and other things that obstruct the works, wipe off slippery items such as greases and oils, and exercise tidy up and cleaning for safe work. An untidy workplace may cause stumbles and slips that result in injury caused by tripping.

FOLLOW SUPERVISOR INSTRUCTION DURING TEAMWORK

Appoint a person who supervises the work and follow his/her instructions in case of Machine repair or installing/uninstalling a work device. Unexpected accidents due to mis-communication between workers may occur during teamwork.

USE APPROPRIATE TOOLS

Do not use damaged or deteriorated tools, or use a tool not intended for the purpose. Use tools suitable for the maintenance work. Entrance of a broken piece of a tool such as a boss with crashed head or a hammer may destroy eyesight.



HANDLING ILLUMINATION DEVICES

- Use explosion-proof illumination devices when inspecting the fuel, oil, battery fluid or similar substance. Failure to use an explosion-proof illumination device may cause leap fire and explosion.
- Attempting to work without using an illumination device in a dark place may cause injury or other issue. Always use an illumination device.
Do not use a lighter or other burning object even if dark. Such use may cause fire, and furthermore the battery gas may catch fire and explode.



STOP ENGINE BEFORE INSPECTION OR MAINTENANCE

- Before inspection or maintenance, always park the Machine at a location where the ground is level, rock-falls and landslides do not occur, is a lowland and flood does not occur, and fully retract and lower the boom, and stop the engine.
- Operate each of the crane operation levers forward backward several times to relieve the pressure remaining in the hydraulic circuits.
- Apply pawls to prevent rubber tracks from moving.
- People in charge of the maintenance should pay attention to prevent body parts and clothes from contacting the moving parts.

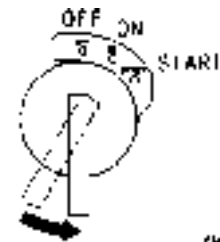

FIRE RISK PREVENTION

- Always observe the followings during maintenance where the fuel, oil, battery or other substance that may catch fire are handled.
- Keep the fuel, oil and any other easily combustible oil and fats away from fire during storage.
 - Do not leave the site when replenishing the fuel or oil.
 - Use incombustible cleaning oil for the objects such as the components, and do not use light petroleum, gasoline or anything else that may catch fire.
 - Do not smoke when inspecting or maintaining. Smoke at a location designated to do so.
 - When inspecting fuel, oil, battery fluid or similar, use explosion-proof illumination devices but do not use fires such as a lighter or a match for illumination.
 - Loosened and damaged electrical connections may cause short circuit that may result in a fire. Inspect accordingly during the inspections before starting work.
 - Make sure a fire extinguisher is in place near the inspection/maintenance site.



5.2 PRECAUTIONS DURING MAINTENANCE

NO UNAUTHORIZED PEOPLE

Do not admit anyone other than necessary workers during maintenance. And post a guard as necessary.
Be especially careful in case of a polishing, welding work, or digging work.

MEASURES UPON FINDING ABNORMALITY DURING INSPECTION

- Always repair whenever an abnormality is found during inspection. Attempt to use without repairing the defect may cause bodily accidents.
- Ask us or our sales service agency for repair depending on the failure type.

DO NOT DROP TOOLS OR PARTS INSIDE THE MACHINE

- Do not drop any bolt, nut or tool inside the Machine when inspecting while opening the inspection port or tank replenishment port. Dropped objects may damage the Machine or cause the Machine to operate improperly and thus may cause accidents. If dropped, always retrieve.
- Do not keep anything unnecessary for the inspection in your pocket.

NOISE CAUTION

Large noise in the surroundings may cause hearing difficulty or deafness.
Put on ear covers or earplugs before long time noise exposure for instance an engine maintenance.

WORK TO BE CARRIED OUT BY AT LEAST TWO PEOPLE DURING MAINTENANCE WITH THE ENGINE RUNNING

To prevent accidents, do not attempt maintenance when the engine is running.

Always observe the followings in case of maintaining with the engine running for unavoidable reason.

- One should be in an operable position by the travelling operation unit of the machine and be ready to stop the engine whenever necessary, and both should keep a good interaction, as well.
- Be especially careful when working near a rotating part which may become entangled.
- Do not touch operation levers. Before handling an operation lever for unavoidable need, always give a sign to other person and let him/her evacuate to a safe place.



XXM12010

PRECAUTIONS WHEN WORKING BELOW THE MACHINE

- Park the Machine over a level and firm location, and fully retract and lower the boom.
- Before the maintenance below the Machine, extend the outriggers to the maximum so the Machine lifts. When doing so, insert support platforms (height increasers) below front and rear of the Machine to stabilize the Machine.



W1025140

CAUTIONS WHEN WORKING ABOVE MACHINE

- Tidy the footing to avoid falling and always observe following precautions during maintenance above the Machine.
- Do not spill oil or grease.
- Do not sprawl the tools.
- Beware of the footing when walking.
- Do not jump from the Machine under any circumstance. Use a platform, and secure your body with three locations of the limbs (both feet and one hand, or both hands and one foot) when climbing up or down the Machine.
- Use protective equipment that suit the work.
- Do not step on the boom, outrigger or machinery cover to prevent bodily accidents such as falling or tripping due to slippage.



A0105470

CAUTIONS WHEN REPLENISHING FUEL OR OIL

The fuel, oils and similar substance may catch fire if a fire comes near.

Gasoline is used as the fuel and thus requires extra effort to observe the followings.

- Keep the engine stopped when supplying.
- Do not smoke when supplying.
- Immediately wipe away dripped fuel or oil.
- Securely tighten the fuel and oil caps.
- Supply fuel/oil at a location with good ventilation.
- Do not leave the site when replenishing the fuel or oil.



A0055023



A0055040

BEWARE OF CHIPS WHEN WORKING WITH HAMMER

During hammering works, keep protective equipment such as protective glasses and a helmet on, and insert a copper bar or similar object between the hammer and the target when hitting.

Giving impact to a hard metal part such as a pin or a bearing may cause a broken chip to enter eye and inflict injury.



A0305480

PRECAUTIONS DURING WELDING REPAIR

Weld in a location with good facilities, and, only authorized personnel are permitted to weld. Unauthorized personnel are strictly prohibited since risks such as gas generation, fire and electrical shock are present when welding.

The personnel authorized to weld are requested to always observe the followings.

- Disconnect the battery terminals to prevent battery explosions.
- Peel off the paint from the welding section to prevent gas generation.
- Attempting to heat up a hydraulic machinery, piping or a section near such part may cause combustible vapor or mist to be generated and catch fire. Avoid heating such section.
- Directly heating a pressurized piping or rubber hose may cause a sudden snip. Apply a fire protection cover.
- Disconnect the wiring connectors of the remote control devices, moment limiter display and converter.
- Put on protective equipment.
- Keep the ventilation well.
- Put away the combustibles and prepare a fire extinguisher.
- Do not ground to a location near electrical part. Such may cause the electrical part to malfunction.

DISCONNECTING THE BATTERY TERMINAL

Disconnect (-) terminal of the battery and stop the electrical flow before repairing the electrical system or starting an electrical weld.

★See "Operation 8. Battery Handling" for details.



CAUTIONS WHEN ADJUSTING RUBBER TRACK TENSION

- Grease is sealed inside the rubber track tension adjuster. The grease is at a high pressure because of the tension of the rubber track. Attempting to release the grease without observing the following precautions may cause the grease valve to pop out and result in a serious accident.
 - Do not loosen the tension adjustment grease valve one full turn or above. Doing so may cause the grease valve may pop out.
 - To avoid the risk during tension adjustment, do not place your body in right front of the grease valve.
- ★ See "Operation 2.1.3 [1] Checking/adjusting Rubber Track Tension" for details.



HIGH PRESSURE HOSE HANDLING CAUTIONS

Oil leaking from high pressure hose may cause fire or bodily accident due to faulty operation. Whenever a damaged hose or loosened bolt is found, abort working and ask us or our sales service agency for a repair.

- Replacement of high pressure hose requires experienced skill. In addition, the tightening torques are decided by the hose types and size. Customers are prohibited to repair.
- Replace the applicable part if any of the following conditions is found.
 - Hose sleeve damage or leak.
 - Scratch or truncation of the coat, or exposure of reinforcing layer of a wire
 - Coat is partially swollen.
 - Indication of twist or collapse is at a movable part of hose.
 - Alien object buried in coating.
 - Hose sleeve deformation.

HIGH PRESSURE OIL CAUTIONS

Failure to make sure the pneumatic circuit pressure is relieved before inspection or replacement of a high pressure piping or hose may result in bodily harm.

Always observe the followings.

- Do not start any inspection or replacement before the pressure dissipates.
- Put on protective glasses and leather gloves.
- When a piping or hose leak exists, the piping/hose itself or vicinity or the ground is wet. If such is seen, a piping crack, hose crack or inflation is considerable, so always ask us or our sales service agency for a repair.
- High pressure oil leaking through a small hole may puncture the skin or destroy eyesight upon contacting with skin or eye. If the high pressure oil gave serious injury to skin or eye, wash away with flowing water and see the doctor as soon as possible.

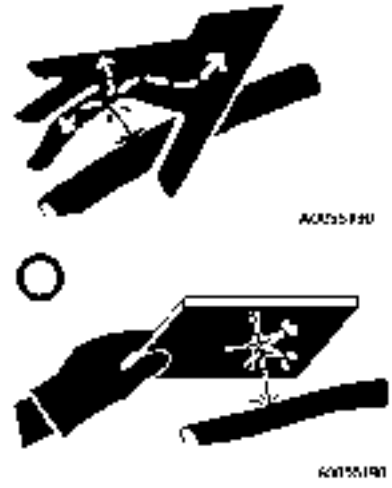

CAUTIONS WHEN TEMPERATURE IS HIGH

Parts such as the engine, all oils, exhaust system manifold and muffler are at high temperature for a short time after stopping the engine.

Attempting to remove the cap or carry out maintenance such as oil draining, water draining or filter replacement may result in suffering burns.

Wait until the temperature lowers, then execute the inspection/maintenance following the procedure written in this manual.

- ★Operation 2.1.2 Checking Before engine starting: checking cooling water level, checking oil level in engine oil pan, checking oil level in hydraulic oil tank.
- ★Maintenance 8.7 50 hours maintenance: Replacement engine lubrication oil and filter cartridge,
- ★Maintenance 8.10 500 hours maintenance: Replacement hydraulic oil return filter
- ★Maintenance 8.11 1000 hours maintenance: Replacement oil inside hydraulic oil tank



CHECKS AFTER INSPECTION/MAINTENANCE

Failure to execute an inspection/maintenance item or failure to check the function and operation of the maintained part may cause an unexpected fault which may result in bodily accidents.

Always observe the followings.

- Checks with engine stopped
 - Check for unexecuted inspection/maintenance.
 - Check that inspection/maintenance was done without errors.
 - Check for any dropped tool or part. Ones caught by the interior or lever related link mechanism poses extra danger.
 - Check for any fuel leak, water leak, oil leak, bolt loose and similar issues.
- Check with engine running

Be fully careful with safety when checking with the engine running while referring to "Work to be carried out by at least two people during maintenance with engine running" section.

 - Check that the inspected/maintained part operates normally.
 - Check that issues such as an oil leak do not occur when load is applied to the oil pressure by increasing the engine rotation.

CAUTIONS WHEN TREATING WASTE

Always observe the following to prevent pollution environment of the district inhabited with human or animal.

- Do not dispose the waste oil down a water system such as a sewer or a river.
- Always drain into a container when draining the oil from the Machine.

Do not directly drain to the ground.

- Observe the applicable legal regulations and rules when disposing harmful substance such as the oil, fuel, solvent, filter or battery.

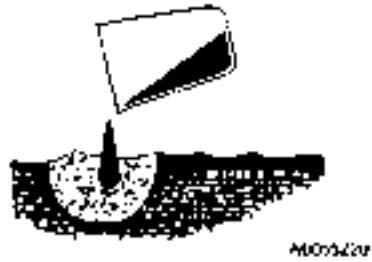

6. SAFETY LABEL LOCATIONS

Keep these labels clean all the time.

If lost, apply again or replace with new one.

Labels other than the following safety labels do exist, treat the same.

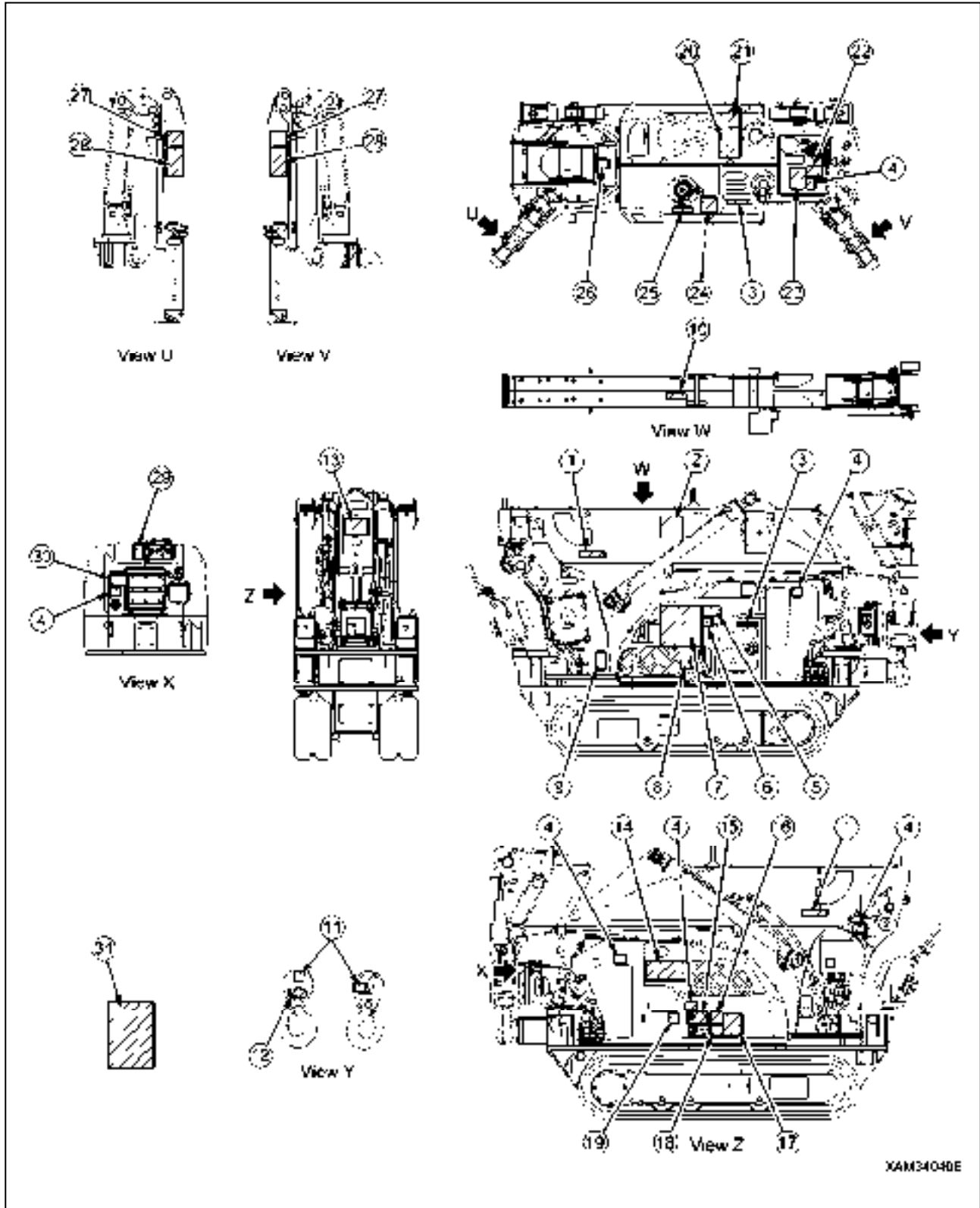

(1) Minimum hoist load (101-4602600) (2 places)

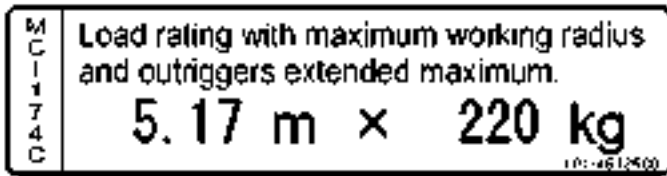

(2) Caution when hoisting machine (350-4589300)

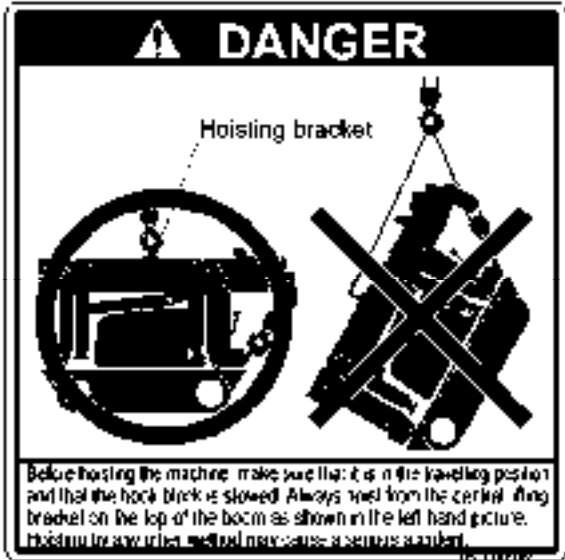

(3) High temperature caution (349-4427800) (2 places) (4) Washing caution (350-4539700) (6 places)

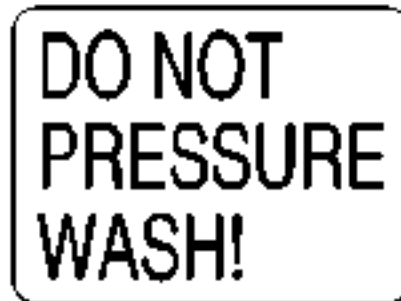

(5) Engine rotation parts caution (553-4268600)



(6) Warning (553-4268000)



(7) Crane operating caution (101-2140500)

<p>MC-1740 Working Radius/Lifting Height Chart</p> <p>Working Radius (m)</p> <p>Lifting Height over ground level (m)</p>	<p>WARNING</p> <ol style="list-style-type: none"> 1. Do not allow rotation to start in any position until fully in line with the jibs. 2. Use outriggers extended to the maximum in principle. 3. For setting correct outrigger pins for particular jobs. <p>- For keeping balance to start outriggers.</p>
<p>Working Radius (m)</p>	<p>CAUTION</p> <ol style="list-style-type: none"> 1. Do not extend jibs past the limit for a particular position of the jibs. 2. Do not allow rotation to start in any position until fully in line with the jibs. 3. Do not allow rotation to start in any position until fully in line with the jibs.
<p>OUTRIGGERS EXTENDED TO MAXIMUM</p>	
	<p>Outrigger Base Outrigger Top</p> <p>Limit Line</p>
<p>WARNING</p> <ol style="list-style-type: none"> 1. Do not allow rotation to start in any position until fully in line with the jibs. 2. Do not allow rotation to start in any position until fully in line with the jibs. 3. Do not allow rotation to start in any position until fully in line with the jibs. <p>101-2140500</p>	

(8) High temperature caution (553-4267700)



(9) No access to crane (349-4422000)



(10) Machine total weight (101-4588900)



(11) Hook block caution (553-4267400) (2 places)



(12) Machine hoisting road (101-4594400)



(13) Caution when travelling on slope (353-4488400)

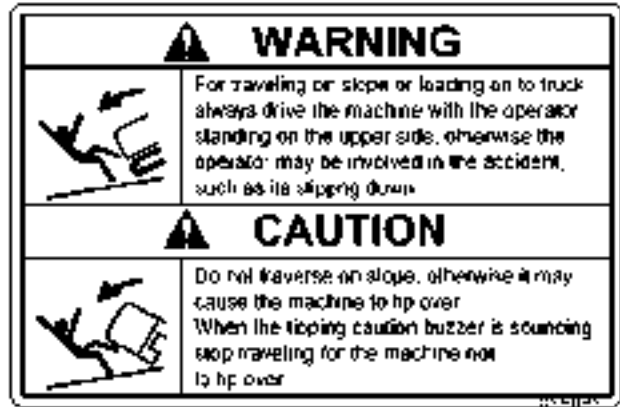

(14) Total rated load chart (101-3314400)

MC-174C Rated Total Load Chart															
Rated Total Load Chart with outrigger extended to maximum								Rated Total Load Chart with outrigger extended to other than maximum							
1.83m Boom		2.97m Boom		4.21m Boom		5.45m Boom		1.83m Boom		2.97m Boom		4.21m Boom		5.45m Boom	
Capacity (kg)	Capacity (lb)	Capacity (kg)	Capacity (lb)	Capacity (kg)	Capacity (lb)	Capacity (kg)	Capacity (lb)	Capacity (kg)	Capacity (lb)	Capacity (kg)	Capacity (lb)	Capacity (kg)	Capacity (lb)	Capacity (kg)	Capacity (lb)
1.0	1.72	1.0	1.72	1.3	1.92	1.7	2.77	1.0	1.22	1.0	1.22	1.3	1.94	1.7	2.72
1.3	1.32	1.3	1.32	1.5	1.12	2.0	0.70	1.3	0.94	1.3	0.94	1.5	0.81	2.0	0.60
1.55	1.09	1.5	1.12	2.0	0.32	2.5	0.66	1.55	0.78	1.5	0.31	2.0	0.60	2.5	0.39
		2.0	0.82	2.5	0.97	2.8	0.59			2.0	0.90	2.5	0.39	2.8	0.33
		2.5	0.67	3.0	0.53	3.0	0.53			2.5	0.39	3.0	0.30	3.0	0.30
		2.59	0.58	3.5	0.42	3.5	0.41			2.59	0.31	3.5	0.22	3.5	0.22
				3.93	0.37	4.0	0.33					3.93	0.18	4.0	0.18
						4.5	0.27							4.5	0.14
						5.17	0.22							5.17	0.10

1. The Rated Total Load Chart is based on actual working radius with the bending of boom attributable to load deflected and is shown with the mass of approx. 20kg, included when:
 2. The third stage boom is extended to any extent work should be performed within the capacity for Boom 4.21m.
 3. If one half or more of the work is exposed from second boom work should be performed within the capacity for Boom 5.45m.
 4. Pouch operation of crane is extremely dangerous. Stick to safe operation.

(15) Caution for remote-control receiver (101-4593000)

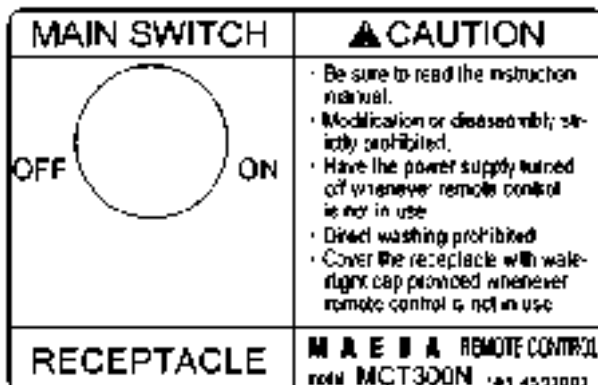

(16) Remote-control receiver error code chart (101-4593100)

ERROR CODES	
If a problem is detected one of the following codes will be shown.	
Error Code	Trouble
E1	Emergency stop activated.
E2	Receiver or Transmitter unit fault.
E5	For resetting, transmitter volume position incorrect.
E6	Problem with receiver EEPROM.
E9	For starting, transmitter switch position incorrect.

101-4593100

(24) Slope caution (353-448600)

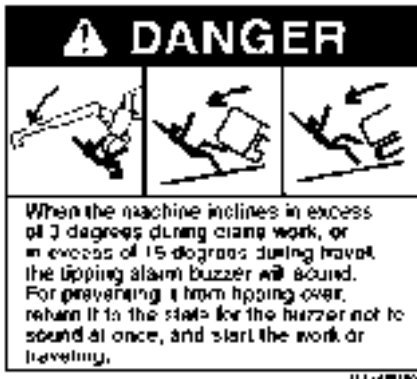

(25) Fire ban (350-4433100)



(26) Winch caution (553-4267500)



(27) Caution when outrigger setting (353-4488700) (4 places)



(28) Outrigger pin hole caution and footing check (101-4593300) (4 places)



(29) Caution when driving, inspecting or maintaining (893-4239100)



(30) Caution on emergency stop cancel (553-4266400)



7. WEEE DIRECTIVE LABEL LOCATIONS

Keep these labels clean all the time.

When replacing electrical equipment on which this label is affixed, always apply a new label.

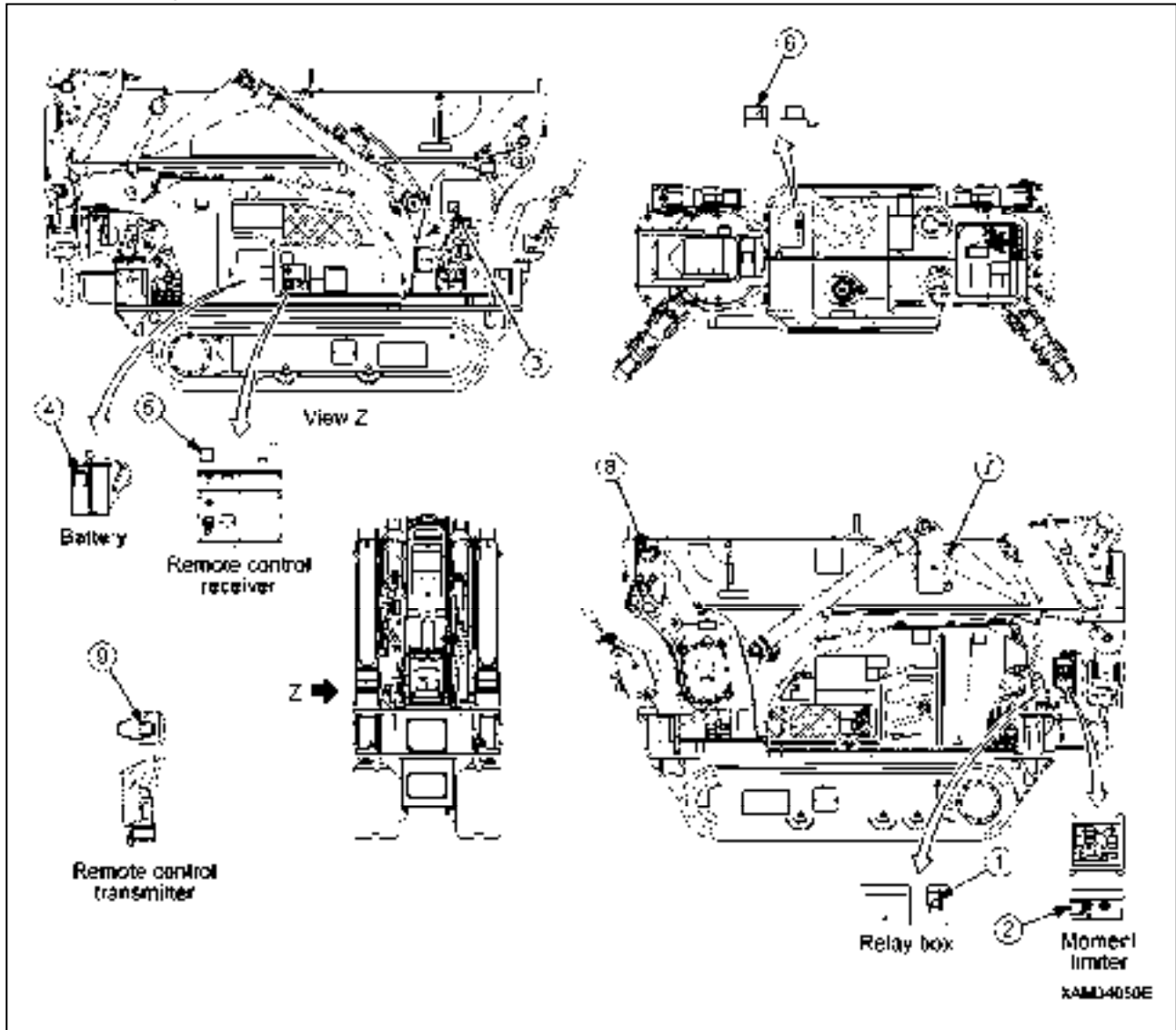

[WEEE DIRECTIVE LABEL (104-4549500)]



[LOCATIONS OF WEEE DIRECTIVE LABELS]

- (1) Side of the relay box at the moment limiter display backward
- (2) Lower side of the moment limiter display
- (3) Side of the moment limiter converter
- (4) Side of the battery
- (5) Top of the remote-controlled receiver
- (6) Side of the inclination sensor
- (7) Side of the boom length detector
- (8) Side of the boom angle detector
- (9) Side of the radio-controlled transmitter

OPERATION

1. MACHINE BY SECTION	3- 2
2. OPERATIONS	3-34
3. HANDLING RUBBER TRACKS	3-93
4. WHAT TO DO WITH TWISTED WINCH WIRE ROPE	3-97
5. TRANSPORTATION	3-98
6. HANDLING IN COLD WEATHER	3-101
7. LONG-TERM STORAGE	3-103
8. HANDLING THE BATTERY	3-104
9. TROUBLESHOOTING	3-109

1. MACHINE BY SECTION

1.1 MACHINE BY UNIT

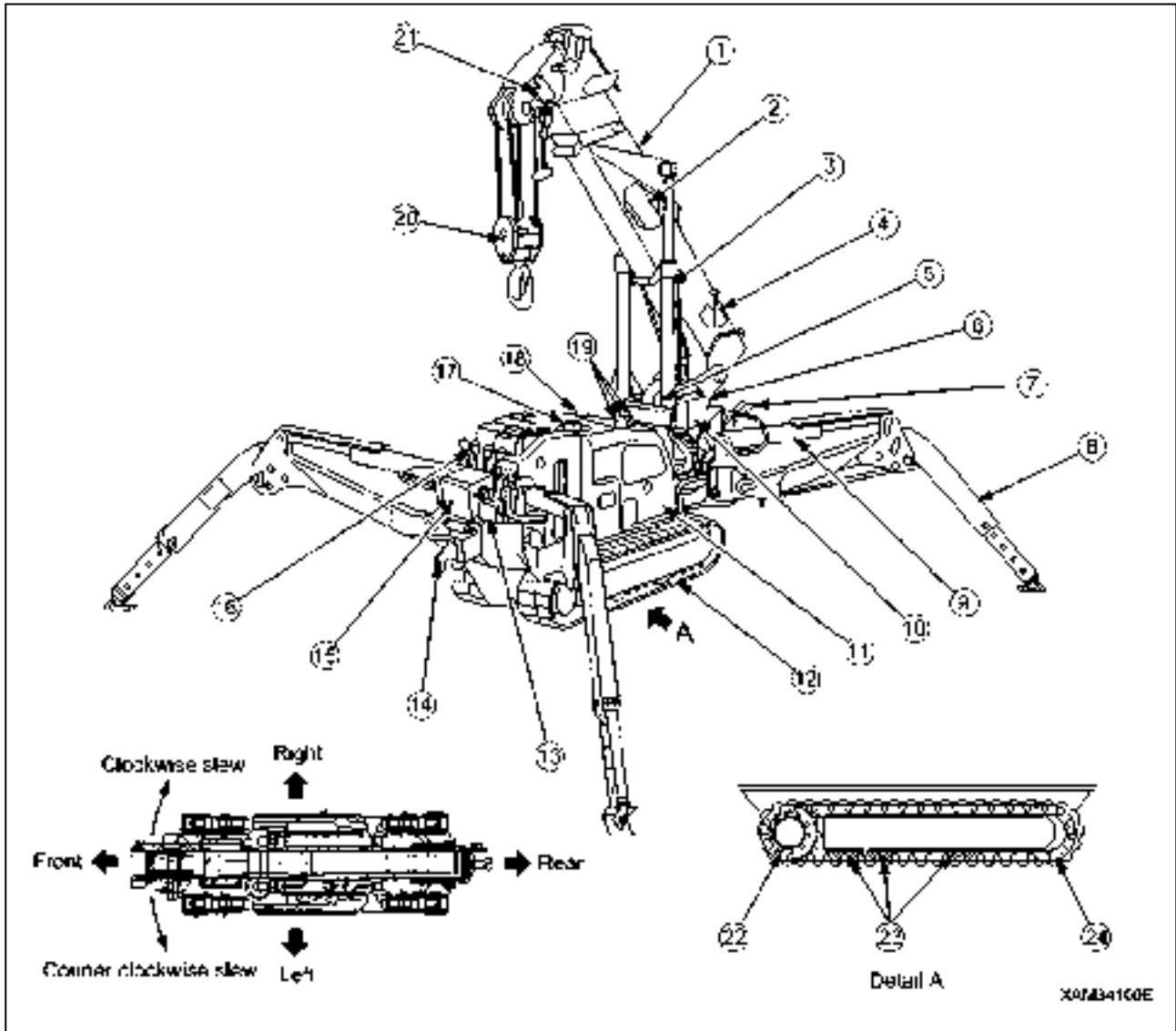

- | | |
|---|--|
| (1) Boom | (13) Headlight |
| (2) Boom telescoping cylinder (Inside the boom) | (14) Hook block hanger |
| (3) Boom derricking cylinder | (15) Moment limiter display unit |
| (4) Boom angle indicator | (16) Crane operation unit |
| (5) Winch | (17) Hydraulic oil tank (Inside machinery cover) |
| (6) Post | (18) Fuel tank (Inside machinery cover) |
| (7) Travelling operation unit | (19) Working status lamp |
| (8) Outrigger | (20) Hook block |
| (9) Outrigger cylinder | (21) Over hoist detector |
| (10) Moment limiter transducer | (22) Travelling motor and sprocket |
| (11) Machinery cover Slewing device | (23) Track roller |
| (12) Rubber track | (24) Idler |

1.2 TRAVELLING OPERATION UNIT

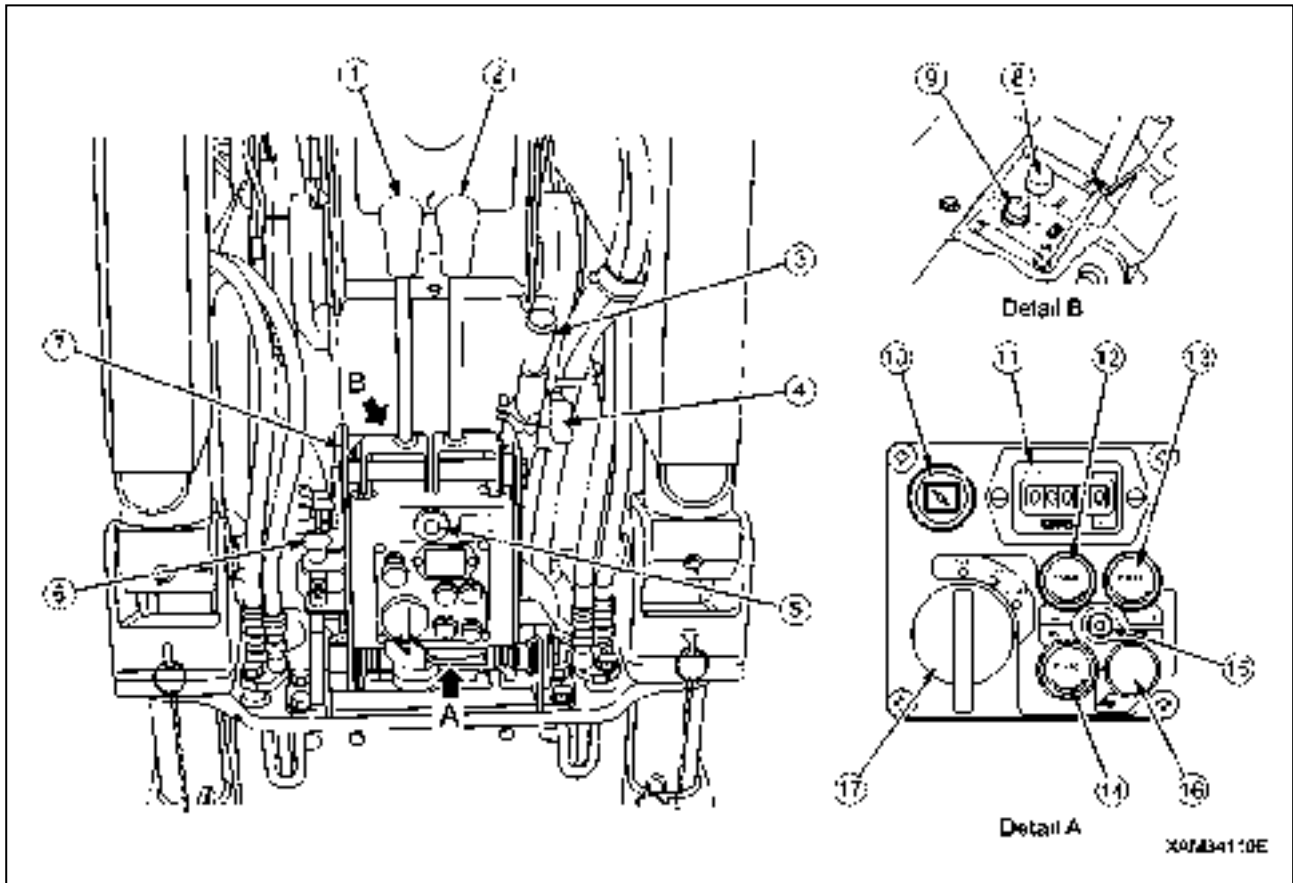

- | | |
|---------------------------------------|--------------------------|
| (1) Left travelling lever | (10) Choke Knob |
| (2) Right travelling lever | (11) Hour meter |
| (3) Grip | (12) Fuse (15A) |
| (4) Acceleration lever | (13) Fuse (15A) |
| (5) Engine emergency stop switch | (14) Fuse (30A) |
| (6) Travelling lever stand lock lever | (15) Battery charge lamp |
| (7) Travelling lever stand | (16) Headlight switch |
| (8) Horn switch | (17) Main starter switch |
| (9) Travelling high-speed switch | |

1.2.1 DESCRIPTION OF EACH LEVER

[1] ACCELERATION LEVER (4)

Use the lever to adjust the engine speed or output.

- Low idling: Pull the lever toward you.
- High speed: Push the lever forward.

NOTES

- At the desired engine speed for your work, release the lever. It will stop at that position.
- Acceleration lever is also provided on the crane operation unit.

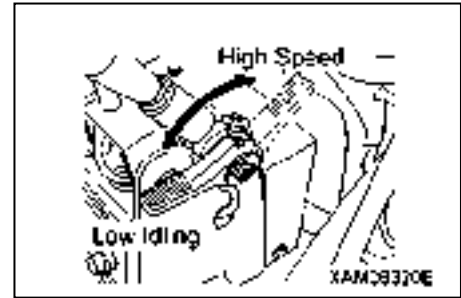

[2] LEFT/RIGHT TRAVELLING LEVER (1), (2)

Use these levers to move the machine forward/backward, stop, slew, and to adjust the travelling speed.

- Forward: Push the left and right levers forward at the same time.
- Neutral: Release your hands from left and right levers at the same time. The levers return to the NEUTRAL position and the machine automatically brakes and stops at that position.
- Backward: Pull the left and right levers toward you at the same time.
- Left turn: Release your hand from the left lever and operate the right lever forward or backward.
- Right turn: Release your hand from the right lever and operate the left lever forward or backward.
- Spin turn: Operate the left and right levers to the opposite direction. The left and right crawlers turn to the opposite direction, allowing you to make the spin turn.

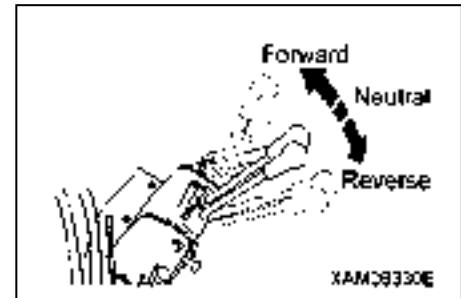

[3] TRAVELLING LEVER STAND (7) AND LOCK LEVER (6)

⚠ WARNING

- Before setting the travelling lever stand to “Travelling position”, be sure to stow the crane and let the machine assume travelling position. Travelling with the crane not in travelling position, may cause it to tip over and cause a serious accident .
- When pulling up the travelling lever stand lock lever, be careful not to contact the travelling lever, as it may cause the undercarriage to move.

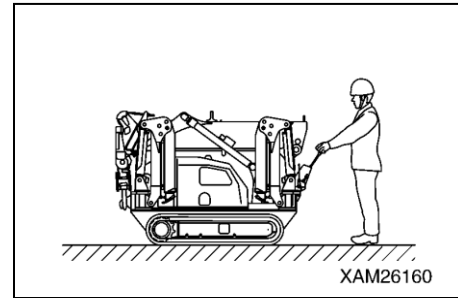

Use this stand to switch the work state of the machine (Travelling control, Crane operation, Stowing position).

- Travel: Pull up the lock lever (6) before erecting the entire lever stand (7) forward to the "Travelling Control Position". The machine is in "Travelling Control Position" when the bottom end of lock lever (6) fits into the guide groove (B).
- Crane: Pull up the lock lever (6) before pressing the whole lever stand (7) down to the "Crane Operation Position". The machine is in "Crane Operation Position" when the end of lock lever (6) fits into the guide (C).

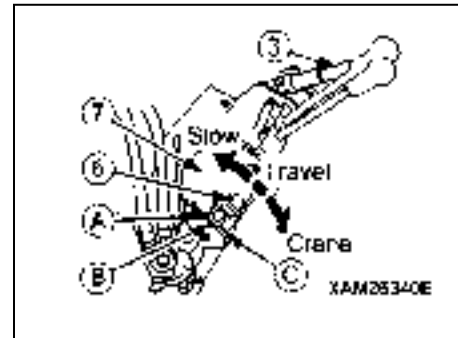

NOTES

- Where the travelling lever stand is set in the “Travelling position”, only travelling operation is available. In such a condition, respective crane control levers and outrigger setting switches are disabled to manage their functions.
- Also, where the travelling lever stand is set in the “Travelling position”, any outrigger setting or crane operations by the Remote Controller are not workable.
- For any outrigger setting or crane operations, set the travelling lever stand in the "Crane Position".

- Stow Position : Pull up the lock lever (6) and grab the Grip (3) to press the whole lever stand (7) down to the "Stow Position". The machine is in "Stow Position" when the end of lock lever (6) fits into the guide (A).

NOTES

When the travelling lever stand is set in the "Stow Position", the whole of the stand can be positioned within the back end of the carrier. (Full length: 2000mm)
This position may be convenient during transportation or when the parking area is restricted.

1.2.2 DESCRIPTION OF EACH SWITCH

[1] STARTER SWITCH (17)

Use this switch to start and stop the engine.

- OFF : You can insert/remove the key at this position. All the switches in the electrical system are turned off and the engine stops.
- ON : Electricity runs into all the circuits.
- START: When the engine has started, release your finger from the key. The key automatically returns to the ON position.

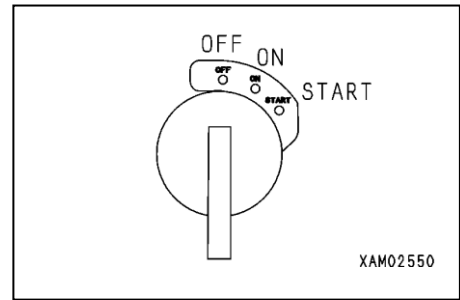

[2] CHOKE KNOB (10)

This knob is to be used when ambient temperature is low and engine is difficult to start.

Use the choke in the following manner:

1. Pull the knob all the way back.
2. Place the starter switch at "START" position.
3. When the engine has started, press the knob to original position.

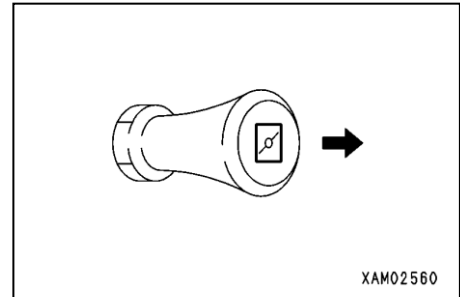

[3] HEADLIGHT SWITCH (16)

Use this switch to turn on the headlights on front of the machine.

- ON: Pull the switch toward you forward. The headlights turn on.
- OFF: Push the switch forward. The headlights turn off.

NOTES

The headlights do not light up even if the headlight switch is operated when the starter switch is at the OFF position.

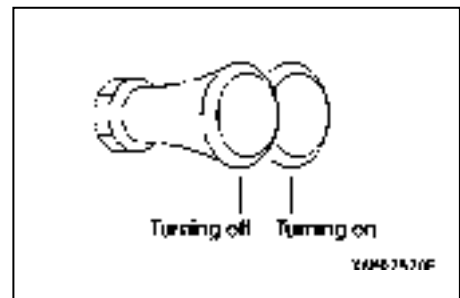

[4] HORN SWITCH (8)

Use this switch to honk the horn.

- Honking the horn: Press the switch.

NOTES

- The horn will stop when you release your finger from the switch.
- The horn switch is provided on the crane operation side as well.

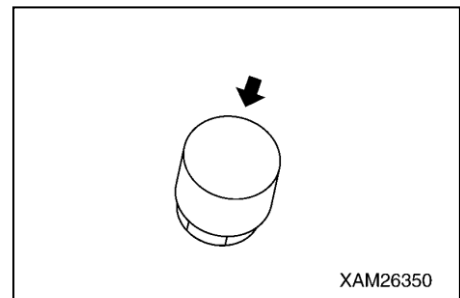

[5] TRAVELLING HIGH-SPEED SWITCH (9)

Use this switch to change the mode of the machine travelling speed.

- ON: Push the switch forward. The travelling speed mode changes to high-speed travelling mode.
- OFF: Push down the switch toward you. The travelling speed mode changes to low-speed travelling mode.

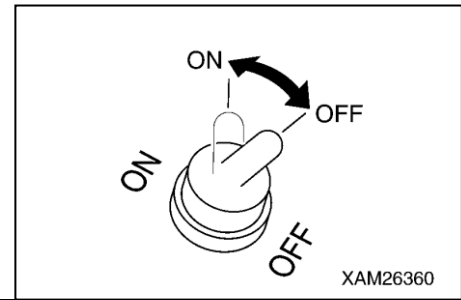

NOTES

- In high-speed travelling mode, you may feel difficulty in changing travelling direction. In such event , it is advisable to switch to low-speed travelling mode.
- During loading to or un-loading from a truck, use low-speed travelling mode since the footing of the operator may become insecure.
- When travelling over uneven terrain, footing of the operator as well as the machine position may become vulnerable. Switch to low-speed travelling mode in such conditions.

[6] ENGINE EMERGENCY STOP SWITCH (5)

Use this switch in case of an error in the machine to stop the machine for emergency.

- ON: Press the switch. The engine stops.
- OFF: Turn the switch clockwise (direction of the arrow in the right figure). The switch returns to the original position.

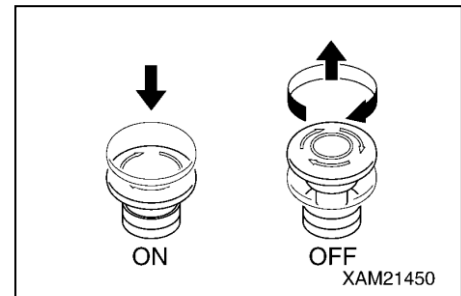

NOTES

When restarting the engine after emergency stop, be sure to turn the engine emergency stop switch to the OFF position before starting the engine.

1.2.3 DESCRIPTION OF EACH METER AND LAMP

[1] HOUR METER (11)

This meter shows the total running hours of the machine.
Use this value as the reference for periodical check interval.
The value in the meter increases when the engine starts.
The value does not change in the condition where the engine stops, though the starter switch is in ON position.

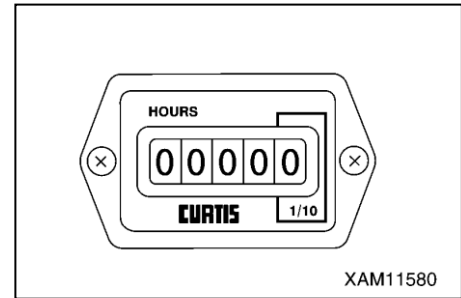

[2] BATTERY CHARGE MONITOR (15)

This monitor indicates errors in the battery charge system.
If it lights up when the starter switch is turned to the ON position and goes off as the engine rotation increases after the engine is started, the battery charge system is normal.
If it lights up during the operation, there is an error in the battery charge system. Immediately stop the machine and check the engine.

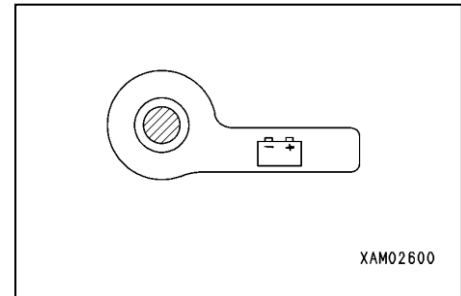

[3] FUSES (12), (13), (14)

⚠ CAUTION

Be sure to turn the starter switch to the OFF position when checking or replacing a fuse.

CAUTION

Fuses protect electrical components and wires from being burnt out.

- Fuses are tubular fuses. If a fuse was corroded and shows white powder, be sure to change the fuse.
- If a fuse has melted down, always check the cause in the circuit and repair the problem before changing the fuse.
- Always use a fuse of the same capacity when replacing one.

Systems and capacities of fuses are as follows:

- Fuse (12) (15A): For remote control system, emergency stop system, engine control system, horn switch, travelling high-speed switch, and moment limiter.
 - Fuse (13) (15A): For lamps, horn and crane inclination alarm system.
 - Fuse (14) (30A): For starter motor, and power source.
1. Turn the fuse holder on control panel counterclockwise and take it out.
 2. Check and replace fuses contained in the removed fuse holder.
 3. Install new or checked fuse to the holder and turn it clockwise to tighten.

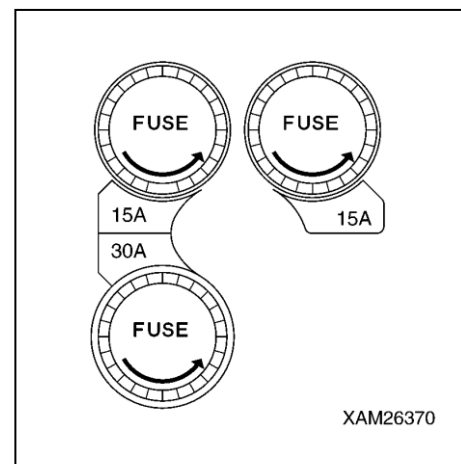

1.3 CRANE OPERATION UNIT

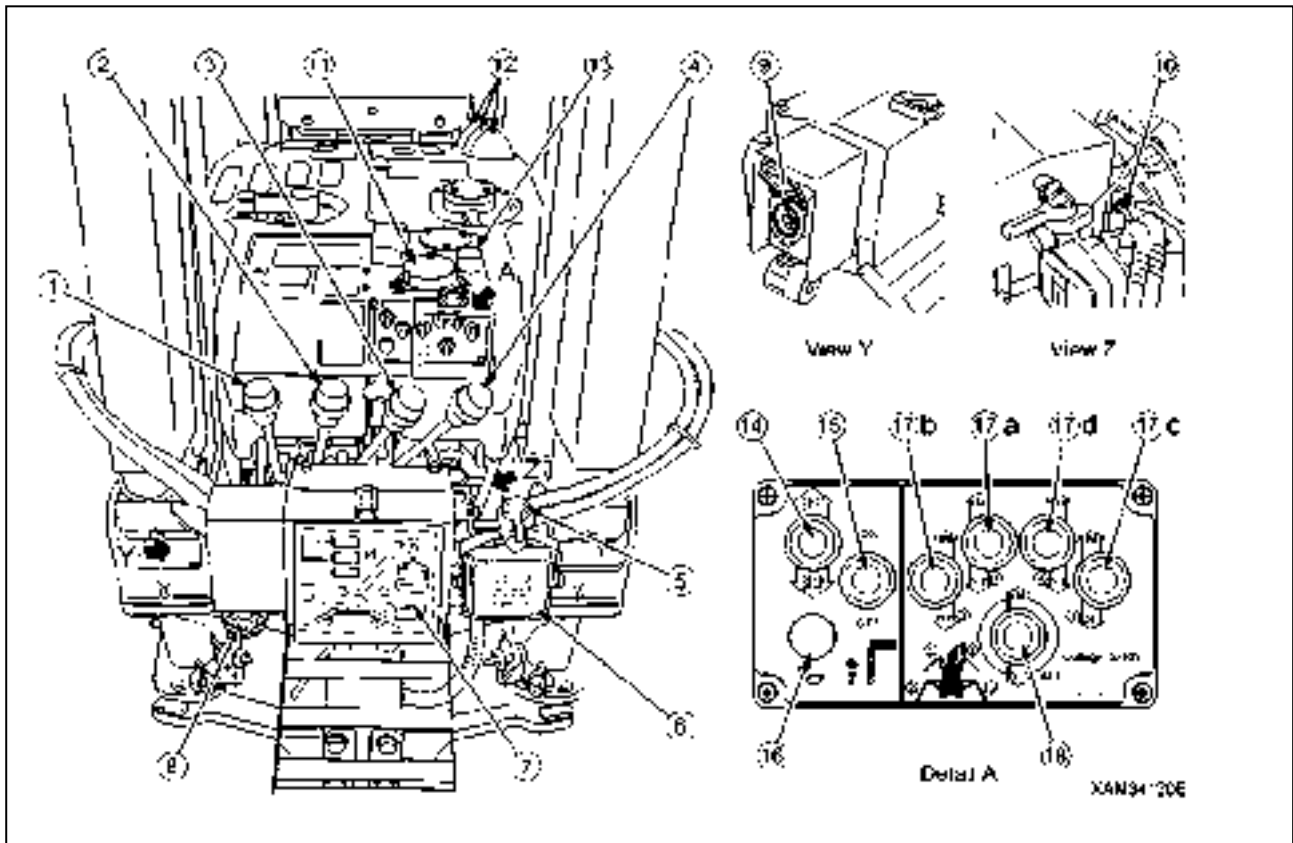

- | | |
|--|--|
| (1) Slewing lever | (12) Working status lamps |
| (2) Boom telescoping lever | (13) Engine emergency stop switch |
| (3) Winch lever | (14) Auxiliary starter switch |
| (4) Boom derricking lever | (15) Hook stowing switch |
| (5) Acceleration lever | (16) Horn switch |
| (6) Headlight | (17) Outrigger individual setting switch |
| (7) Moment limiter display panel | (a) Outrigger (1) setting switch |
| (8) Over hoist and moment limiter alarm buzzer | (b) Outrigger (2) setting switch |
| (9) Emergency stop cancel switch | (c) Outrigger (3) setting switch |
| (10) Boom stowing switch | (d) Outrigger (4) setting switch |
| (11) Level | (18) Outrigger collective setting switch |

1.3.1 DESCRIPTION OF EACH LEVER

[1] ACCELERATION LEVER (5)

Use the lever to adjust the engine speed or output.

- Low idling: Turn the lever to counter clockwise.
- Full speed: Turn the lever to clockwise.

NOTES

- At the desired engine speed for your work, release the lever. It will stop at that position.
- Acceleration lever is also provided on the travelling control unit.

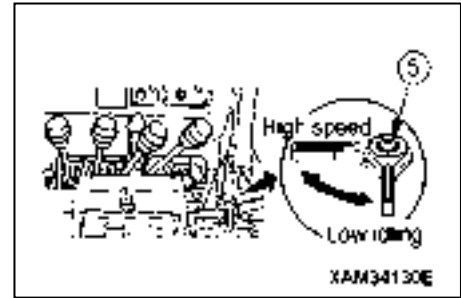

[2] SLEWING LEVER (1)

Use the lever to slew the crane boom and post.

- Slew counter clockwise: Push the lever forward (Left).
- Neutral: Release your hand from the lever.

The lever returns to the NEUTRAL position and the slewing stops.

- Slew clockwise: Pull the lever toward you (Right).

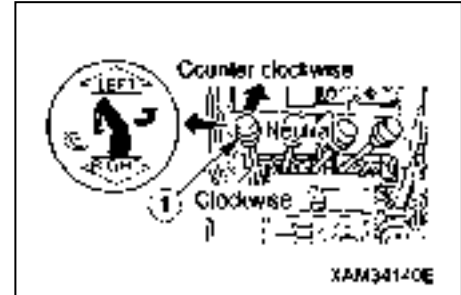

[3] BOOM TELESCOPING LEVER (2)

Use this lever for telescoping the crane boom.

- Extend: Push the lever forward (Extend).
- Neutral: Release your hand from the lever.

The lever returns to the NEUTRAL position and the boom telescoping stops.

- Retract: Pull the lever toward you (Retract).

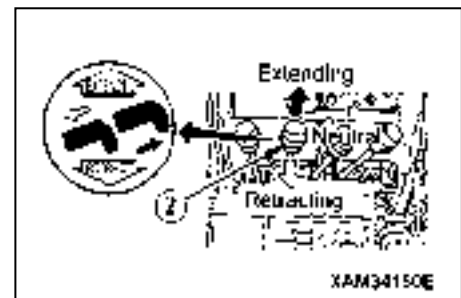

[4] WINCH LEVER (3)

Use this lever to raise/lower the hook block of the crane.

- Lower: Push the lever forward (Down).
- Neutral: Release your hand from the lever.

The lever returns to the NEUTRAL position and the machine automatically brakes. The lowering/raising of the hook block stops.

- Raise: Pull the lever toward you (Up).

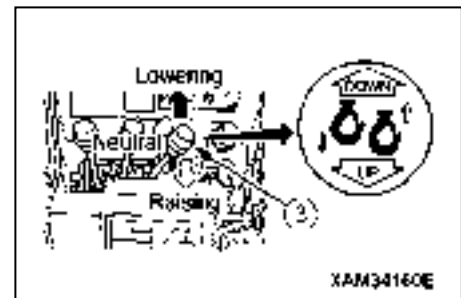

[5] BOOM DERRICKING LEVER (4)

Use this lever for derricking the crane boom.

- Lower: Push the lever forward (Lower).
- Neutral: Release your hand from the lever.

The lever returns to the NEUTRAL position and the boom derricking stops.

- Raise: Pull the lever toward you (Raise).

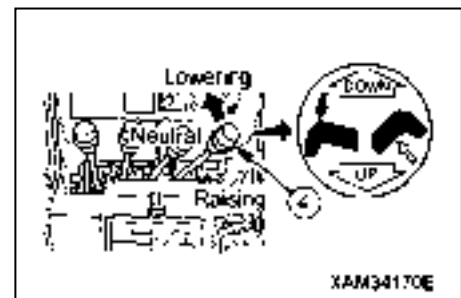

1.3.2 DESCRIPTION OF EACH SWITCH

[1] EMERGENCY STOP CANCEL SWITCH (9)

⚠ DANGER

- Do not turn the emergency stop cancel switch to the ON (cancel) position except in a machine failure condition or when conducting a load test. When the emergency stop cancel switch is in ON position, the moment limiter functions are not available. Any crane operation in such conditions will result in dropping of hoisted load, breakage of crane boom, and/or crane tipping due to over load, and may cause a serious accident resulting in death or serious injury. Key for the switch must be detached during normal operations.
- Do not turn the emergency stop cancel switch to the ON (cancel) position when stowing the hook.
The winch wire rope may be cut causing the hook to fall on or damage the boom.
Use the hook stowing switch when stowing the hook.

Use the emergency stop cancel switch only for the purpose to release emergency stop when the safety device of the Crane seems to have a failure, or when a load test is required.

Open the cover when using the switch.

- ON (Clear): Insert the key into the switch. Turn the key clockwise and retain the key at that position. The activation stop function is cleared while the key is maintained at the ON position.
- OFF (Auto): Insert the key into the switch and turn the key counterclockwise. The activation stop functions. The key can be removed or inserted at this position.

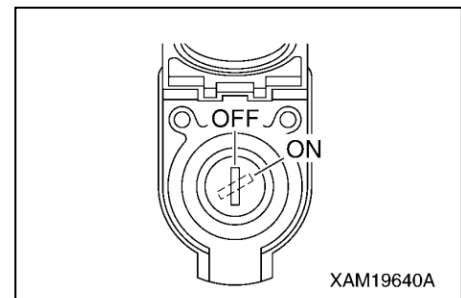

[2] BOOM STOWING SWITCH (10)

⚠ WARNING

- The boom stowing switch cancels the auto-stop function of the lower-limit detecting interlock device during the boom “lowering” operation. Operate the boom derricking lever carefully when stowing the boom. Pay sufficient attention not to let the boom collide with the machine body.
- Use the boom stowing switch only when stowing the boom.

Use this switch to stow the boom.

- ON: Keep pushing the switch downward and operate the boom derricking lever to “LOWER” side. The boom lowers and can be stowed.
- OFF: Release your finger from the switch. The switch returns to the original position and the auto-stop function of the lower-limit detecting interlock device will be activated.

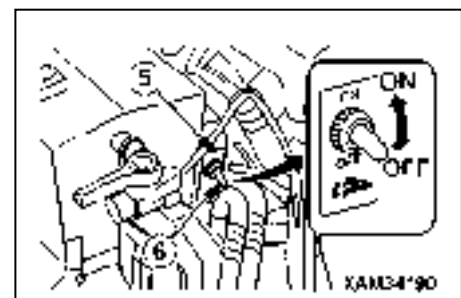

[3] ENGINE EMERGENCY STOP SWITCH (13)

Use this switch in case of an error in the machine to stop the machine for emergency.

- ON: Press the switch. The engine stops.
- OFF: Turn the switch clockwise (direction of the arrow in the right figure). The switch returns to the original position.

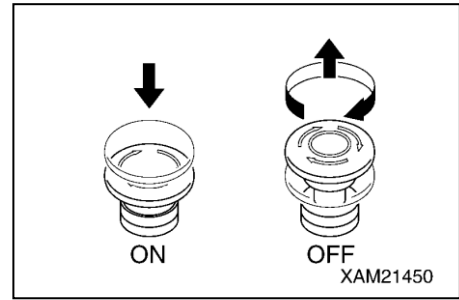

NOTES

When restarting the engine after emergency stop, be sure to turn the engine emergency stop switch to the OFF position before starting the engine.

[4] AUXILIARY STARTER SWITCH (14)

CAUTION

The auxiliary starter switch functions only while main starter switch at travel control is in ON position. To start-up engine using the auxiliary starter switch, the main starter switch must remain at ON position.

Use this switch to start and stop the engine.

- START: Keep pushing the switch upward. The engine starts.
When the engine has started, release your finger from the switch.
- Neutral: Release your finger from the switch. The switch returns to the NEUTRAL position.
- STOP: Keep pushing the switch downward. The engine stops.
When the engine has stopped, release your finger from the switch.

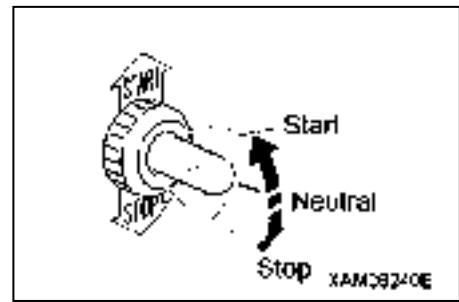

[5] HOOK STOWING SWITCH (15)

WARNING

- The hook stowing switch cancels the auto-stop function of the over hoist detector. Operate the winch lever carefully when stowing the hook block. Pay sufficient attention not to let the hook block collide with the boom.
- Use this switch only when stowing the hook block.
- When the hook block is stowed in the hook block holder and the wire rope slacking is eliminated, turn OFF the hook stowing switch without delay. Otherwise, the wire rope will be over-wound which causes it to wedge into the winch drum.

Use this switch to stow the hook block at the lower top of the machine.

- ON: Keep pushing the switch upward. The over hoist detector is released and the hook block is wound up slower than the normal operation mode, so that it is stowed in the hook holder.
- OFF: Release your finger from the switch. The switch returns to the original position and the auto-stop function of the over hoist detector will be activated.

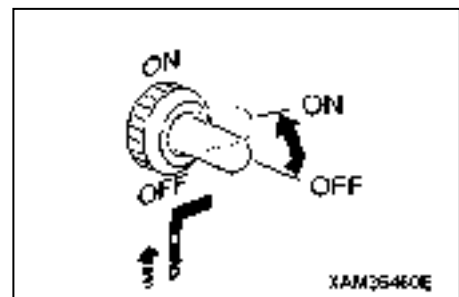

[6] HORN SWITCH (16)

Use this switch to honk the horn.

- Honking the horn: Press the switch.

NOTES

- The horn will stop when you release your finger from the switch.
- The horn switch is provided on the travelling control side as well.

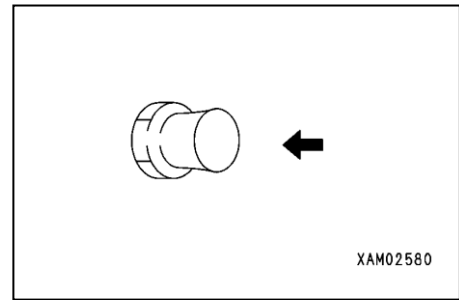

[7] OUTRIGGER SETTING SWITCH (17), (18)

Use these switches to install or stow each of 4 [(1) to (4)] outriggers.

Outrigger setting switch includes 4 Outrigger individual setting switches (17) and 1 Outrigger collective setting switch (18).

4 Outrigger individual setting switches enable to control each of 4 [(1) to (4)] outriggers separately.

In contrast, the Outrigger collective setting switch enables to control all the 4 [(1) to (4)] outriggers simultaneously.

- IN : Turn the switch upward.
Outrigger cylinder retracts and the outrigger is stowed.
- Neutral: Release your finger from the switch.
The switch returns to its NEUTRAL position and extending or retracting of the outrigger is interrupted.
- OUT : Turn the switch downward.
Outrigger cylinder extends and the outrigger is installed.

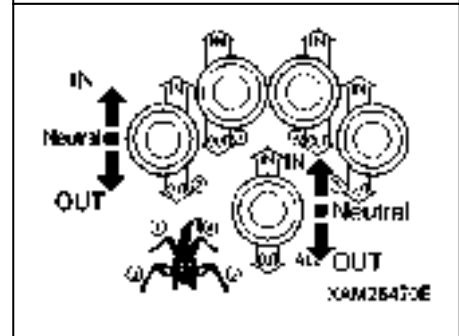
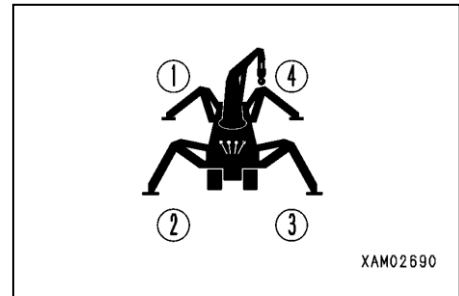

[8] LEVEL (11)

⚠ WARNING

When installing the outrigger, make adjustments while looking at the level so that the machine body will be leveled. Performing the crane operation with the body tilted will cause overturning.

This device indicates how much the machine body is tilted.

The bubble position shows how much the machine is tilted in which direction.

Use this device to verify that the machine is leveled when setting the outriggers.

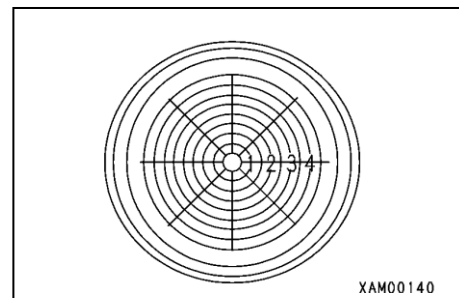

[9] WORKING STATUS LAMPS (12)

Color of each working status lamp shows current load factor (ratio of the hoisting load weight to rated total load).

- Red lamp (12A) shows LIMIT WARNING where the load factor is 100 % or higher than the rated total load, when it is lit.
- Yellow lamp (12B) shows PRE-WARNING where the load factor is 90 to less than 100 % of the "rated total load, when it is lit.
- Green lamp (12C) shows SAFETY ZONE where the load factor is less than 90 % of the rated total load, when it is lit.

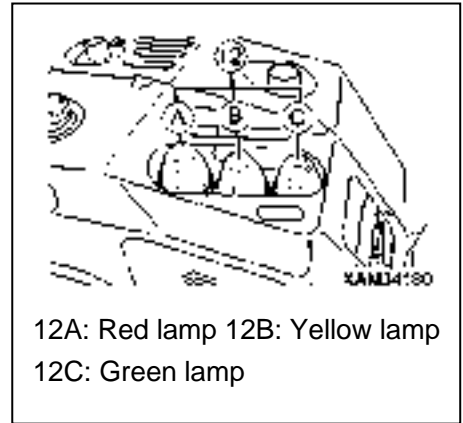

12A: Red lamp 12B: Yellow lamp
12C: Green lamp

1.4 MOMENT LIMITER (OVERLOAD DETECTOR)

1.4.1 MOMENT LIMITER CONFIGURATION

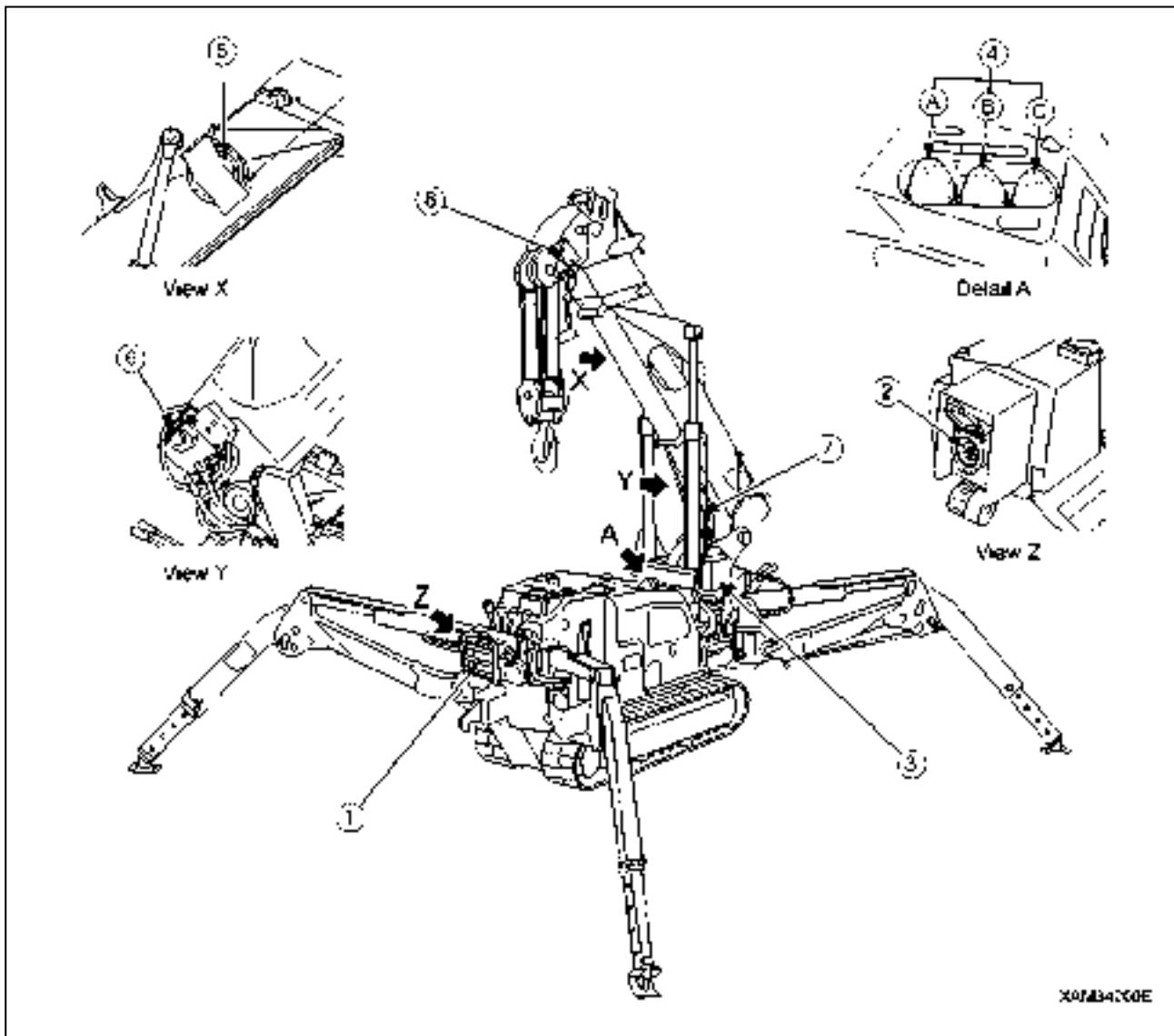

- (1) Moment limiter display unit
- (2) Emergency stop cancel switch
- (3) Moment limiter converter
- (4) Working status lamp
 - (A) Red working status lamp (Warning lamp for load factor of 100% or more)
 - (B) Yellow working status lamp (Pre-warning lamp for load factor of 90 to 100%)
 - (C) Green working status lamp (Working lamp for load factor of less than 90%)
- (5) Boom length sensor (right side of boom)
- (6) Boom angle sensor (right side of boom edge)
- (7) Pressure sensor (derricking cylinder) (two)
- (8) Overwind alarm detector (left side of boom top)

1.4.2 FUNCTION OF MOMENT LIMITER

⚠ DANGER

- Do not remove, disassemble, or repair detectors. Do not move the detectors to another location from original position.
- Should an object hit a detector or you find any damage on a detector, be sure to verify the actuation status of the auto stop.

If you find any abnormality with the actuation of the auto stop, do not fail to fix it.

- Do not turn ON (cancel) the emergency stop cancel switch unless you find an error or check/perform maintenance on detectors.

Overloading can cause the hoisted load to fall, boom breakage, or overturning of this machine that can lead to serious accidents resulting in death or serious injury.

- The machine will not stop automatically even if the crane is overloaded during the crane slewing operation.

Do not slew the crane when being overloaded.

- When the boom approaches the stop position during the operation, be sure to change the operation speed of the boom to low speed.

With high-speed boom operation, the boom may overrun the specified stop position, causing serious accidents such as overturning of the machine resulting in death or serious injury.

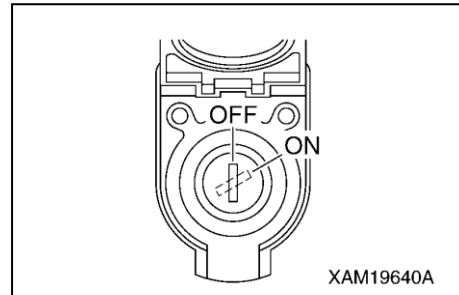

The moment limiter is a device installed to prevent the hoisted load from falling, the boom from breaking, or the machine from overturning due to overloading.

Always check the operation of the moment limiter before crane operation to verify no abnormality.

[1] MECHANISM OF MOMENT LIMITER

The moment limiter calculates current "rated total load" by knowing the current boom position by the boom angle sensor and the boom length sensor, by knowing the outrigger extension condition by the outrigger position switch, and by knowing the number of wire falls (entered by the operator).

Then by actually hoisting a load, the "read load" (hoist load) is sent from the pressure sensor of the derricking cylinder to the moment limiter.

The moment limiter comparatively calculates between the "rated total load" computed out of the current position and the "actual load" (hoisted load), and issues an alarm if the result indicates the real load/rated total load=90 to 100%.

If the calculation result indicates the actual load/rated total load=above 100%, an alarm is issued and the causes the boom operation to automatically stop.

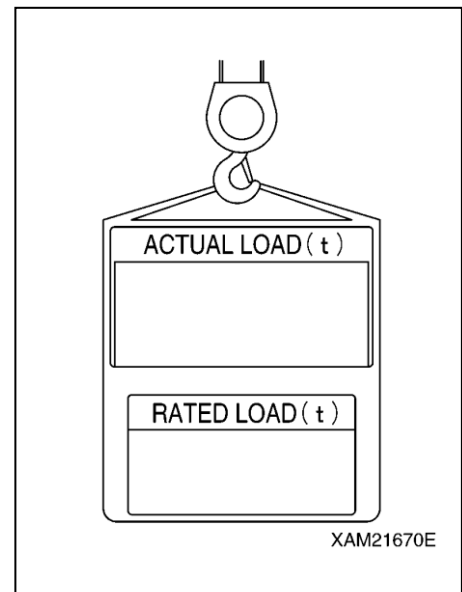

[2] DISPLAY OF THE MOMENT LIMITER ERROR MESSAGES

The moment limiter performs self-diagnosis on the moment limiter display unit when an error is issued by the boom angle sensor, boom length sensor, pressure sensor, or when a circuit is opened or a connector is disconnected.

The result is displayed on the "Rated Total Load Display" of the moment limiter display unit by an error code to notify the operator of the error.

Immediately stop the use of the crane when an error code is displayed.

See "Operation 1.4.9 Moment Limiter Error Causes and Actions to be Taken".

1.4.3 MOMENT LIMITER OPERATIONS

The moment limiter is a device for unexpected events. Do not rely solely on the device to avoid danger. Pay sufficient attention during the operation not to cause auto-stop of the crane.

[1] PROHIBITED ACTIONS AFTER AUTO STOP

⚠ DANGER

The following crane operations are prohibited after the crane has stopped automatically due to overloading. These operations may cause overturning of the machine or breakage of the boom and are very dangerous.

- Boom lowering operation
- Boom extending operation
- Hook raising operation
- Crane slewing operation

[2] MOMENT LIMITER OPERATIONS

⚠ DANGER

Be sure to switch the engine speed to low speed and perform crane operation carefully if the moment limiter load factor is 90% or higher.

Performing crane operation at high engine speed will swing the hoisted load and is very dangerous, causing overloading and it may break the boom.

1. Safety Zone (With load factor of “less than 90%”)

When the hoisting load is less than 90% of the rated total load, the working status lamp lights in green, indicating normal operation status.



★Green lamp light up

2. Pre-Warning (With load factor of “90 to less than 100%”)

When the hoisting load reaches 90% of the rated total load (pre-warning), the working status lamp changes from green to yellow and the alarm sounds intermittently, notifying the operator and those around that the hoisting load is close to the rated total load.



★Yellow lamp light up

3. Limit Warning (With load factor of “100% or higher”)

When the hoisting load reaches 100% of the rated total load by continuing the crane operation after exceeding 90% of the rated total load (pre-warning), the working status lamp changes from yellow to red and the alarm now sounds continuously. The following crane operations will stop automatically.

- Hook raising operation
- Boom extending operation
- Boom lowering operation

The LED of “100%” on the moment limiter load factor display lights up.



★Red lamp light up

4. Recovery Operation from Auto Stop

The recovery operation from overloading should be the reverse operation of the crane operation that caused the auto stop. Perform one of the followings.

(1) Lower the hook and put down the hoisted load on the ground.

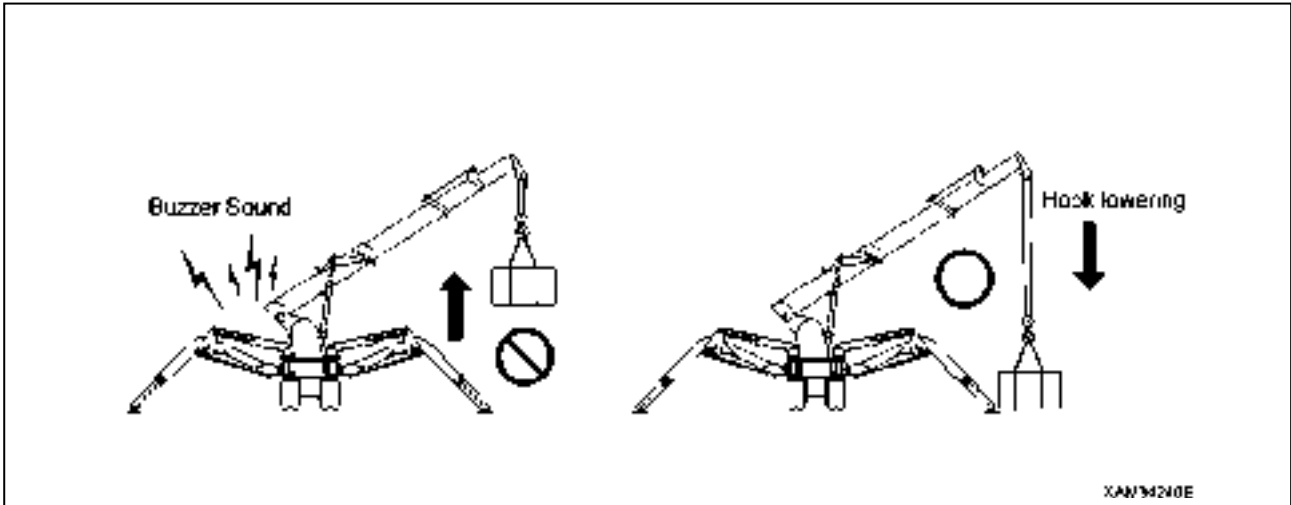

(2) Raise the boom. Lower the hook so that the hoisted load will be as low as possible.

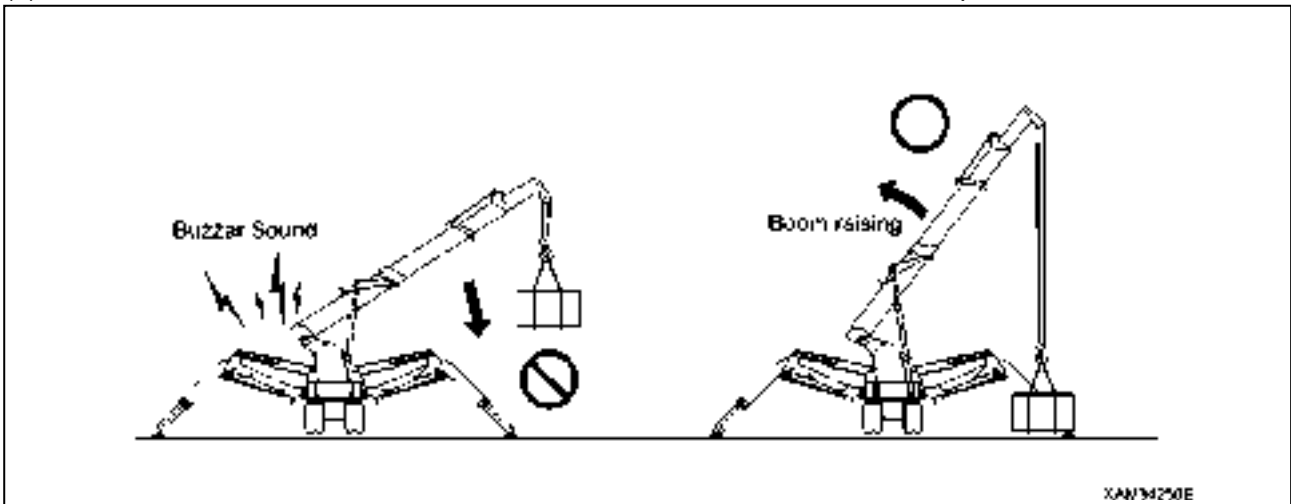

(3) Retract the boom.

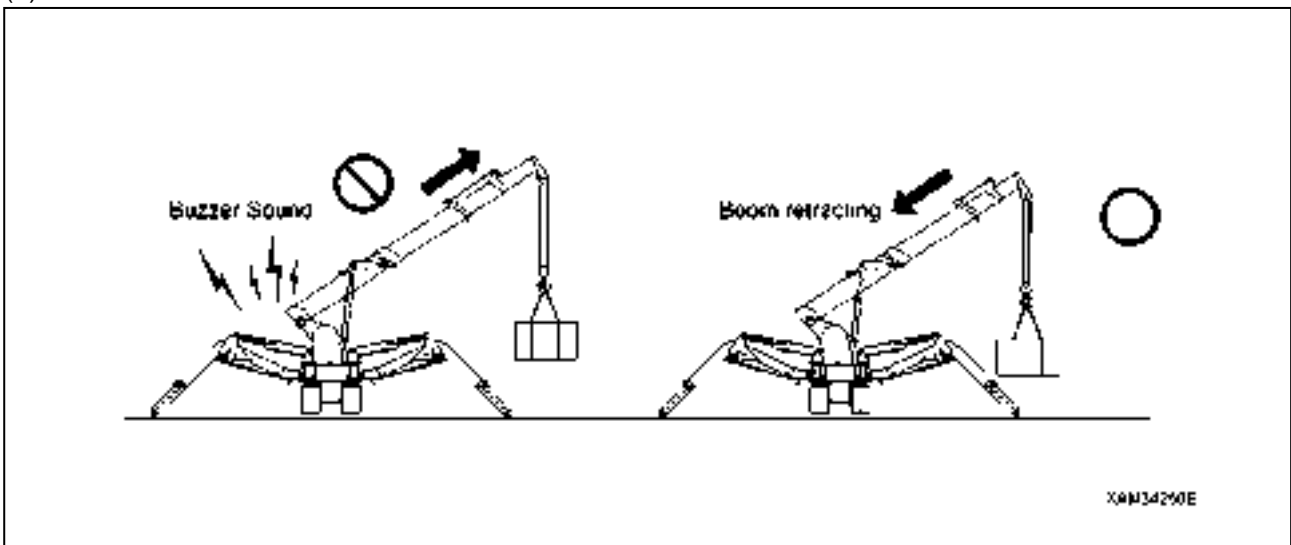

1.4.4 NAMES OF MOMENT LIMITER DISPLAY UNIT

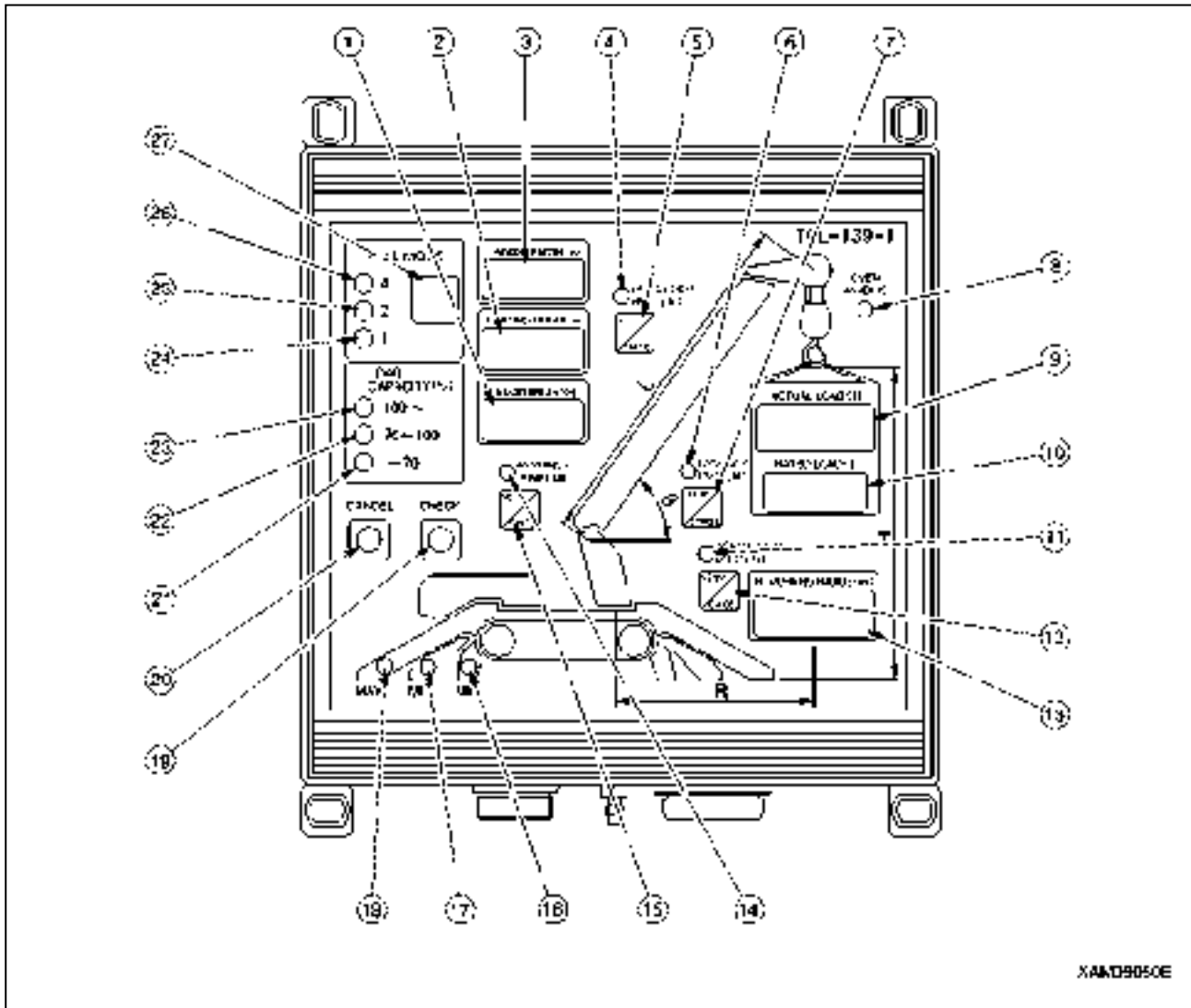

- | | |
|---|--|
| (1) Boom angle display | (16) Outrigger MIN. extension LED (Orange) |
| (2) Lifting height display | (17) Outrigger MID. extension LED (Orange) |
| (3) Boom length display | ★Not in use MC-174C. |
| (4) Boom lifting height upper limit LED (Red) | (18) Outrigger MAX. extension LED (Orange) |
| (5) Boom lifting height upper limit switch | (19) Check switch |
| (6) Boom angle lower limit LED (Red) | (20) Cancel switch |
| (7) Boom angle lower limit switch | (21) Load capacity less than 70% LED (Orange) |
| (8) Over hoist detection LED (Red) | (22) Load capacity 70 to less than 100% LED (Orange) |
| (9) Actual load display | (23) Load capacity 100% or more LED (Orange) |
| (10) Rated total load display | (24) 1-fall fall LED (Orange) |
| (11) Working radius upper limit LED (Red) | (25) 2-falls fall LED (Orange) |
| (12) Working radius upper limit switch | (26) 4-falls fall LED (Orange) |
| (13) Working radius display | (27) Fall mode selector switch |
| (14) Boom angle upper limit LED (Red) | |
| (15) Boom angle upper limit switch | |

[1] DESCRIPTIONS OF SWITCHES ON MOMENT LIMITER DISPLAY UNIT

1. WIRE FALLS SELECTOR SWITCH AND WIRE FALLS DISPLAY LED (ORANGE)

⚠ DANGER

- **When entering the number of wire falls, verify the actual used number of wire falls and make sure to set up correctly.**
Entering incorrect number of wire falls may prevent pre-warnings and boom auto-stop even when the overload is being approached, and thus may result in crane damage or machine trip that may result in serious accidents.
- **Stop the crane operation when changing the number of wire falls using the number of wire falls selector switch.**
Changing the number of wire falls during the crane operation can cause unexpected accidents.
- **Perform the crane operation always after matching the number of wire falls displayed on the moment limiter and the actual number of wire falls. Mistaking the number of wire falls causes serious accidents.**

The wire rope has the safe load per rope fall determined.

Determine the number of wire falls according to the maximum load to be hoisted.

With this machine, the hook for four wire fall of rope is referred to as the standard specifications.

The last status of the set number of wire falls is memorized even if the starter switch is turned to the OFF position.

Use this switch to change the number of wire falls.

- Keep pressing the switch for 2 seconds or more.

The setting changes from “4-falls” to “1-fall”.

At the same time, the wire falls display LED changes from “4-falls” to “1-fall”, indicating that the setting has changed.

- Then each time you press the switch for 2 seconds or more, the setting of the wire falls changes from “1-fall” to “2-falls”, and then from “2-falls” to “4-falls”.

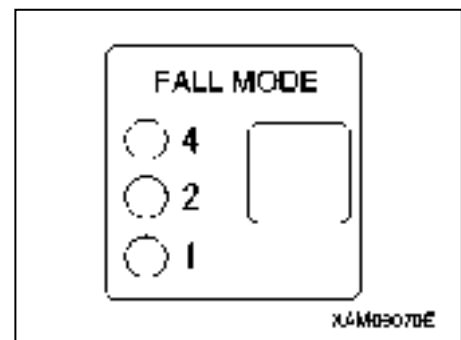

NOTES

When changing the setting, right after doing so, release your finger from the switch, and then press the switch again.

2. BOOM ANGLE UPPER LIMIT SWITCH AND LED (RED)

Use this switch to set or cancel the boom angle upper limit.

[SETUP]

With no upper limit value being set, set the boom to the angle you would like, and press the switch for 2 seconds.

The boom angle at this point is set as the upper limit.

At the same time, the LED lights up indicating that the upper limit value was set.

To enable this setting, turn the key switch to the ON position again after turning it to the OFF position, or lower the boom by “10 degrees” or more from the set boom angle to get out of the pre-warning zone while the engine is being started.

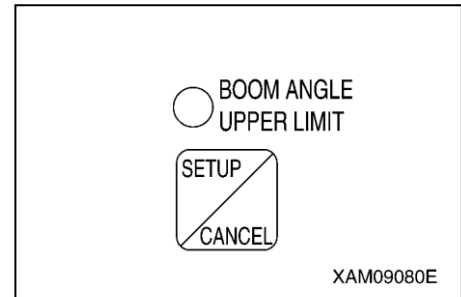

NOTES

Be sure to verify that the boom automatically stops at the set angle before performing the actual operation. If the boom does not stop automatically, re-set the boom angle using the procedure above.

When the boom reaches the pre-warning zone or stops at the upper limit with the boom angle upper limit set, the boom angle upper limit LED flashes.

[CANCEL]

With the upper limit value being set (LED ON), press the switch for 5 seconds.

The current upper limit value setting will be cleared. At the same time, the LED goes off indicating that the upper limit value setting is cleared.

NOTES

The setting and canceling will not repeat even if you keep the switch pressed for more than 2 seconds. Let your finger go off the switch and press the switch again.

3. BOOM ANGLE LOWER LIMIT SWITCH AND LED (RED)

Use this switch to set or cancel the boom angle lower limit.

[SETUP]

With no lower limit value being set, set the boom to the angle you would like, and press the switch for 2 seconds.

The boom angle at this point is set as the lower limit.

At the same time, the LED lights up indicating that the lower limit value was set.

To enable this setting, turn the key switch to the ON position again after turning it to the OFF position, or raise the boom by “7 degrees” or more from the set boom angle to get out of the pre-warning zone while the engine is being started.

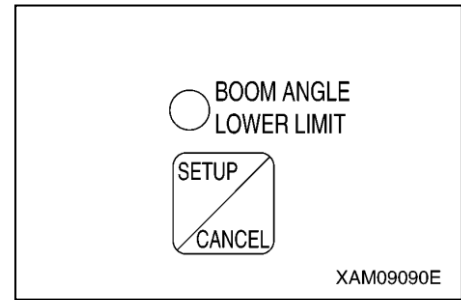

NOTES

Be sure to verify that the boom automatically stops at the set angle before performing the actual operation. If the boom does not stop automatically, re-set the boom angle using the procedure above.

When the boom reaches the pre-warning zone or stops at the lower limit with the boom angle lower limit set, the boom angle lower limit LED flashes.

[CANCEL]

With the lower limit value being set (LED ON), press the switch for 5 seconds.

The current lower limit value setting will be cleared. At the same time, the LED goes off indicating that the lower limit value setting is cleared.

NOTES

The setting and canceling will not repeat even if you keep the switch pressed for more than 2 seconds. Let your finger go off the switch and press the switch again.

4. WORKING RADIUS UPPER LIMIT SWITCH AND LED (RED)

Use this switch to set or cancel the working radius upper limit.

[SETUP]

With no upper limit value being set, set the boom to the working radius you would like, and press the switch for 2 seconds.

The working radius at this point is set as the upper limit.

At the same time, the LED lights up indicating that the upper limit value was set.

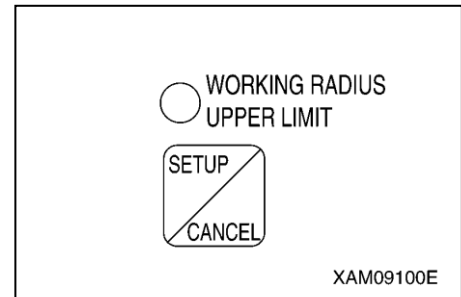

To enable this setting, turn the key switch to the ON position again after turning it to the OFF position, or reduce the working radius by “1.3 m” or more from the set working radius to get out of the pre-warning zone while the engine is being started.

NOTES

Be sure to verify that the boom automatically stops at the set working radius before performing the actual operation. If the boom does not stop automatically, re-set the working radius using the procedure above.

When the boom reaches the pre-warning zone or stops at the upper limit with the working radius upper limit set, the working radius upper limit LED flashes.

[CANCEL]

With the upper limit value being set (LED ON), press the switch for 5 seconds.

The current upper limit value setting will be cleared. At the same time, the LED goes off indicating that the upper limit value setting is cleared.

NOTES

The setting and canceling will not repeat even if you keep the switch pressed for more than 2 seconds. Let your finger go off the switch and press the switch again.

5. LIFTING HEIGHT UPPER LIMIT SWITCH AND LED (RED)

Use this switch to set or cancel the lifting height upper limit.

While the lifting height is restricted by detecting the height of the tip of the boom, the lifting height on the display panel shows the lifting height when the hook was raised to the over hoist detection status.

[SETUP]

With no upper limit value being set, set the boom to the lifting height you would like, and press the switch for 2 seconds.

The lifting height at this point is set as the upper limit.

At the same time, the LED lights up indicating that the upper limit value was set.

To enable this setting, turn the key switch to the ON position again after turning it to the OFF position, or reduce the lifting height by “1.3 m” or more from the set lifting height to get out of the pre-warning zone while the engine is being started.

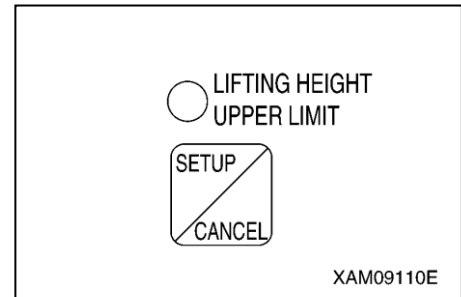

NOTES

Be sure to verify that the boom automatically stops at the set lifting height before performing the actual operation. If the boom does not stop automatically, re-set the lifting height using the procedure above.

When the boom reaches the pre-warning zone or stops at the upper limit with the lifting height upper limit set, the lifting height upper limit LED flashes.

[CANCEL]

With the upper limit value being set (LED ON), press the switch for 5 seconds.

The current upper limit value setting will be cleared. At the same time, the LED goes off indicating that the upper limit value setting is cleared.

NOTES

The setting and canceling will not repeat even if you keep the switch pressed for more than 2 seconds. Let your finger go off the switch and press the switch again.

6. CANCEL SWITCH

Use this switch to cancel the all setting sets in the section 2 to 5 above.

- Press this switch and “CHECK” switch at the same time for 5 seconds or more.

The all value sets in the section 2 to 5 above will be canceled.

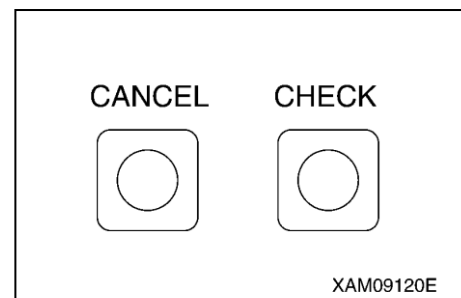

7. CHECK SWITCH

Use this switch to verify the values set in the section 2 to 5 above.

- Press this switch. Every time the switch is pressed, the set value will be displayed in the following order.

- (1) "Boom angle upper limit value" is displayed at the boom angle display section.
- (2) "Boom angle lower limit value" is displayed at the boom angle display section.
- (3) "Working radius upper limit value" is displayed at the working radius display section.
- (4) "Lifting height upper limit value" is displayed at the lifting height display section.
- (5) Returns to the original display.

NOTES

- When a set value is displayed, the LED for its setting switch section flashes at the same time.
- If no switch was pressed for 5 seconds or another switch was pressed with a set value being displayed, the display goes back to the original display.
- The display will be a blank for the item to which no value is set.
- The display sections other than for the corresponding items will be blank.

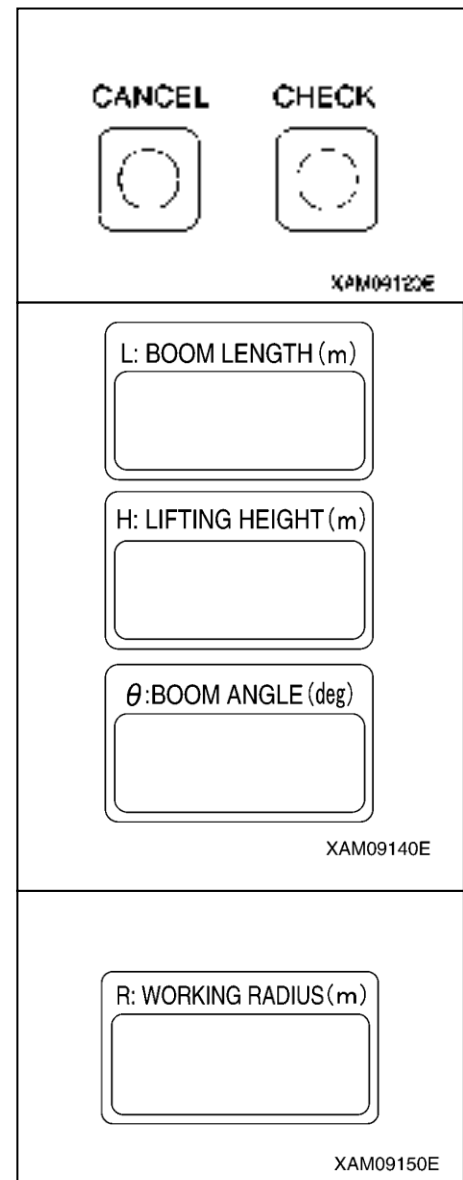

[2] DESCRIPTIONS OF MOMENT LIMITER DISPLAY UNIT

For LEDs not described in this section, see “Operation 1.4.4 Names of moment limiter display unit”.

1. ACTUAL LOAD DISPLAY SECTION

This section constantly displays the actual load of the hoisted load during the crane operation.

The actual load indicates the total weight of the hoisted load and lifting ring excluding the hook weight.

If “0.0” to “0.1” is displayed when nothing is being hoisted, the system is normal.

If the value displayed is out of this range, contact us or our sales service agency.

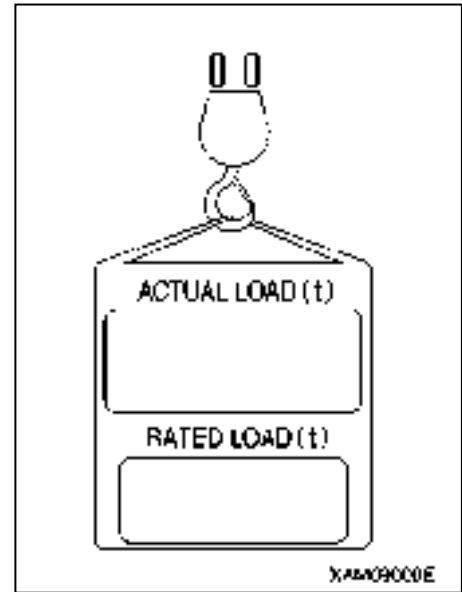

2. RATED TOTAL LOAD DISPLAY SECTION

This section displays the number of wire falls on the hook, working radius, currently hoistable rated total load (hook weight + lifting ring weight + load to be hoisted) computed out of the conditions such as the degree of outrigger extension.

3. WORKING RADIUS DISPLAY SECTION

This section constantly displays the current working radius during the crane operation.

The working radius is the horizontal distance from the crane slewing centre to the centre of the hook.

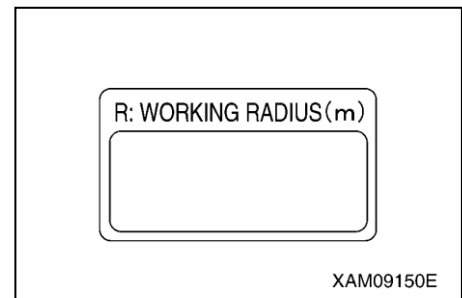

4. BOOM LENGTH DISPLAY SECTION

This section constantly displays the current boom length during the crane operation.

The boom length is the distance from the boom foot pin to the sheave pin at the end of the boom.

5. LIFTING HEIGHT DISPLAY SECTION

This section constantly displays the current lifting height during the crane operation.

The lifting height is the vertical distance from the ground to the bottom of the hook.

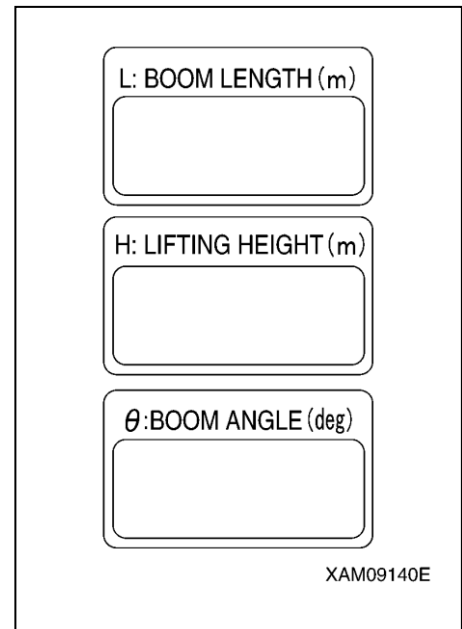

6. BOOM ANGLE DISPLAY SECTION

This section constantly displays the current boom angle during the crane operation.

The boom angle is the angle the boom and the horizontal line form.

7. OVER WINDING LED (RED)

This LED flashes up when the hook is overwound, and issues overwinding warning and causes an automatic stop.

This LED also flashes when the hook is stowed during the hook stowing operation. This is normal.

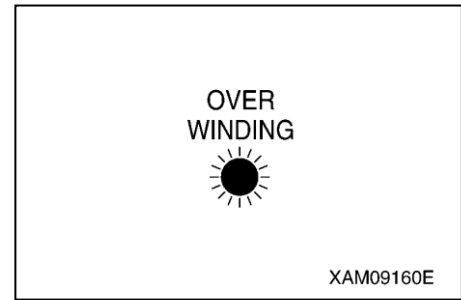

8. OUTRIGGER EXTENSION LED (ORANGE)

The LED lights up to indicate the outrigger extension status.

- If any of the four outriggers has not properly reached the maximum extension position, the "MIN" LED lights up.
- If all the four outriggers reach the maximum extension position, the "MAX" LED lights up.

Even if you thought you had set the outriggers at the maximum extension position, the "MIN" LED lights up if any of the outriggers did not properly reach the maximum extension position.

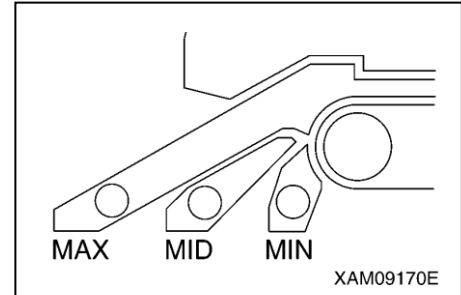

NOTES

This machine is not capable of detecting the middle extension position. Please be careful as "MID" LED does not light.

9. LOAD FACTOR DISPLAY (ORANGE)

This display indicates the status of the moment limiter load factor by its illumination.

- Where the load factor is less than 70% of the rated total load, "-70" LED lights up.
- Where the load factor is 70 to less than 100% of the "rated total load, "70 - 100" LED lights up.
- Where the load factor is 100% or higher than the rated total load, "100 -" LED lights up.

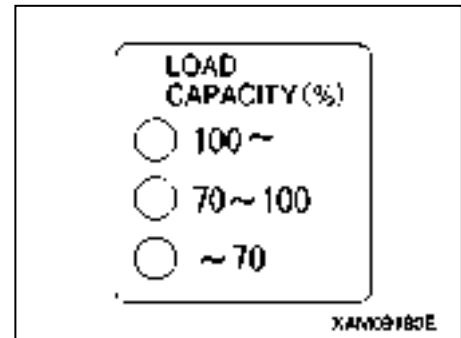

1.4.5 OTHER MOMENT LIMITER FUNCTIONS

[1] WORKING ENVELOPE RESTRICTION WARNING

When the working envelope gets close to the set restriction value, a warning is issued to notify the operator and people around of the situation.

The last status of the set value for the working envelope restriction is memorized even if the starter switch is turned to the OFF position.

NOTES

See "Operation 1.4.4 [1] Descriptions of Switches on Moment Limiter Display Unit" for how to set the value for working envelope restriction.

When the working envelope has been set, the restriction will be as follows.

1. SAFETY ZONE

- The appropriate working envelope restriction LED (red) lights up.
- Green of the working status lamp lights up.

2. PRE-WARNING

- The appropriate working envelope restriction LED (red) lights up.
- The alarm sounds intermittently.
- Yellow of the working status lamp lights up.

3. LIMIT WARNING

- The appropriate working envelope restriction LED (red) lights up.
- Red of the working status lamp lights up.
- The alarm sounds continuously.
- The appropriate operation of the crane stops automatically.

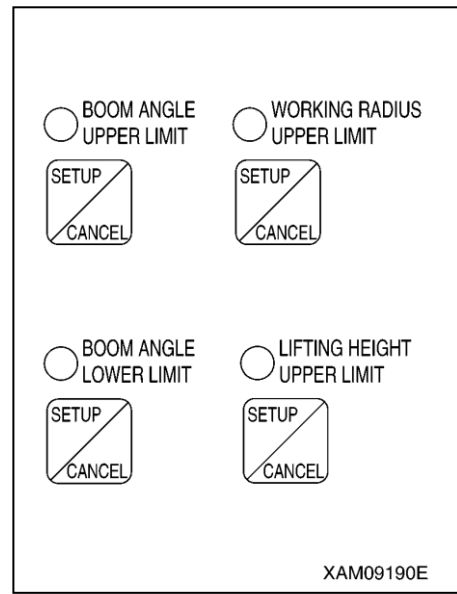

[2] OVER HOIST DETECTOR

CAUTION

**Pay attention to the distance between the hook and boom when raising the hook.
Extending the boom also raises the hook.
Always check the hook height when extending the boom.**

When you overwind the hook when raising the hook or extending the boom,

- The "Overwinding" LED (red) flashes.
- The alarm sounds continuously. (It stops sounding when the operation lever is released.)
- The hook raising, boom extending and boom raising operation stop automatically.

In case of auto stop, immediately perform the recovery operation. Perform hook lowering and boom retracting operations as recovery operations.

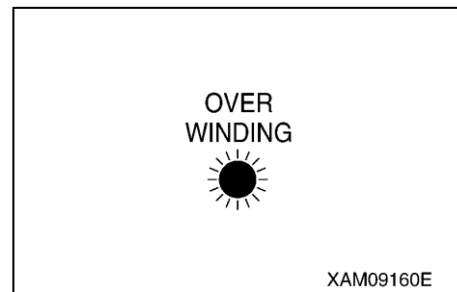

[3] BOOM UPPER LIMIT DETECTION

When the boom is raised and the boom angle reaches “about 77 degrees”, the boom raising operation stops automatically.

[4] BOOM LOWER LIMIT DETECTION

When the boom is lowered and the boom angle reaches “about 3 degrees”, the boom lowering operation stops automatically.

1.4.6 MOMENT LIMITER STARTING STATUS

CAUTION

- **If the red of the working status lamp does not go off after completing the functional check of the moment limiter, be sure to contact us or our sales service agency.**
- **If the travelling lever stand is set in the "Travel Position", the Moment Limiter is not turned ON. To turn it ON, don't forget to set the travelling lever stand in the "Crane Operation Position".**

The moment limiter checks its function for 2 seconds when the starter switch is turned to the ON position. Meanwhile,











- The red of the working status lamp lights up.
- All the LEDs light up.

Then, if the moment limiter and the sensors are normal upon the completion of the functional check of the moment limiter, the red of the working status lamp goes off and green of the working status lamp lights up indicating that the machine is ready for use.

1.4.7 MOMENT LIMITER ERROR CAUSES AND ACTIONS TO BE TAKEN

The moment limiter displays an error code at the “rated total load” display section on the display panel to notify the error.

If an error code shown in the table below was displayed, contact us or our sales service agency.

Error Code	Error Details	Actions to Be Taken
E1L 	The input to pressure sensor 1 is lower than the specified value.	Check the installation of the pressure sensor 1.
E1H 	The input to pressure sensor 1 is higher than the specified value.	
E2L 	The input to pressure sensor 2 is lower than the specified value.	Check the installation of the pressure sensor 2.
E2H 	The input to pressure sensor 2 is higher than the specified value.	
E3L 	The input to angle detector is lower than the specified value.	Check the installation of the angle detector.
E3H 	The input to angle detector is higher than the specified value.	
E4L 	The input to length detector is lower than the specified value.	Check the installation of the length detector.
E4H 	The input to length detector is higher than the specified value.	
EAD 	The AD converter at the converter section is not functioning properly.	Turn the starter switch to the OFF position and then to the ON position again. If an error is displayed again, change the converter.
ERS 	The communication between the converter section and the display unit is not carried out properly.	<ul style="list-style-type: none"> • Check the cable between the display unit and the converter. If the cable is normal, change the converter. • Check the fuse built-in the converter.
E-E 	Error with calibration memory. This error is also issued when calibration has not been done yet.	Turn the starter switch to the OFF position and then to the ON position again. If an error is displayed again, change the display unit.
No displayed	---	Check the fuse built-in the display unit.

1.5 OVER HOIST DETECTOR

CAUTION

Pay attention to the distance between the hook block and the boom when raising the hook block.

The hook block also raises when the boom is extended.

Always check the height of the hook block when performing the boom extending operation.

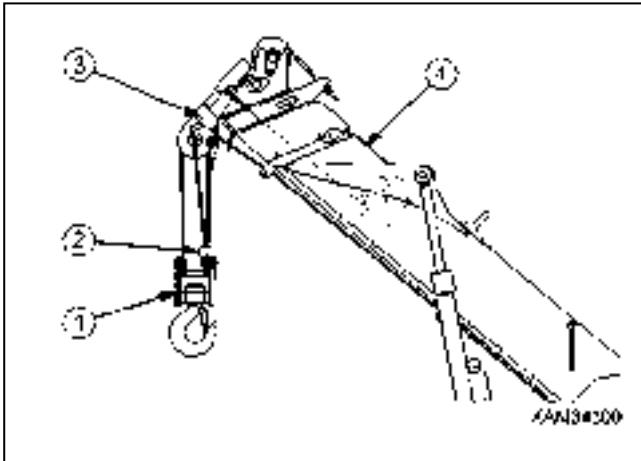

- (1) Hook block
- (2) Over hoist detector weight
- (3) Over hoist detector
- (4) Boom

The over hoist detector is a device which automatically stops operation as listed below, it also sounds the Over hoist and moment limiter alarm buzzer (5) to warn of an over hoisting condition, when the hook block (1) comes close to the Boom tip and lifts the weight (2) up:

- Hook raising
- Boom telescoping
- Boom raising

When the Over hoist and moment limiter alarm buzzer (5) beeps, return all of the Winch lever, Boom telescoping lever and Boom derricking lever to the NEUTRAL position immediately, then push the Winch lever forward (Down).

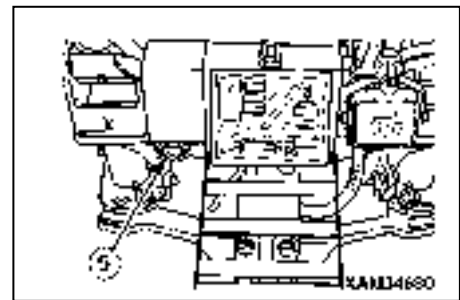

1.6 MACHINERY COVER

⚠ WARNING

- Be sure to stop the engine and remove the starter switch key before removing the machinery cover.
- Do not remove the machinery cover immediately after the operation while the engine is still hot.

[1] REMOVING MACHINERY COVER

Remove the machinery cover with the following procedure when performing inspection/maintenance inside the machinery cover.

1. Remove 9 mounting bolts (2) from the left side machinery cover (1).

NOTES

The mounting bolts (2) are being used in quantity of 1 at the crane operation unit, 3 at the top, 3 at the rear and 2 at the forward left lower side.

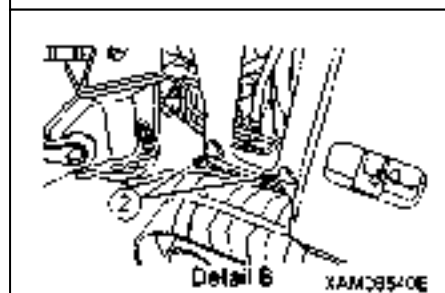
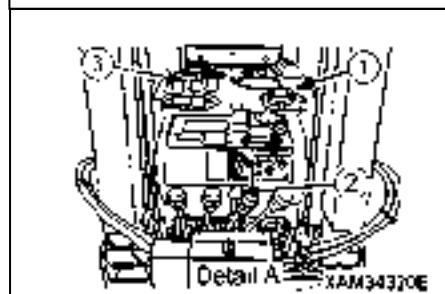
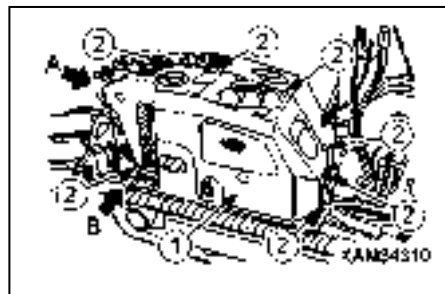

2. Remove 3 mounting bolts (4) from the right side machinery cover (3).

NOTES

The mounting bolts (4) are being used in quantity of 1 at the rear lower side and 2 at the right lower side.

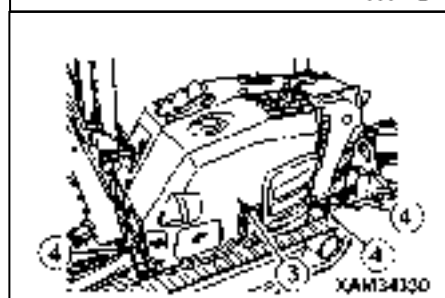

3. Remove the left side machinery cover (1).

4. Remove the right side machinery cover (3).

[2] INSTALLING MACHINE COVER

When you finished inspection/maintenance in the machinery cover, install the machinery cover using the reverse procedure to that for removing it.

When you complete re-installation, always check each part for any interference condition.

2. OPERATIONS

2.1 CHECKS BEFORE OPERATION

2.1.1 CHECKS BEFORE STARTING THE ENGINE (VISIBLE CHECKS)

⚠ WARNING

- This machine has a gasoline engine.
If it smells of fuel around the engine, the fuel may be leaking. Carefully check for cracks on the fuel hose or fuel hose connections.
- Buildup of combustibles and oil leakage around the hot engine section such as engine and muffler and around the battery can cause fire in the machine.
Carefully check around these areas. Should you find any abnormality, be sure to fix it or contact us or our sales service agency.

Check the items shown in this section as routine surveillance before starting the first work of every day.

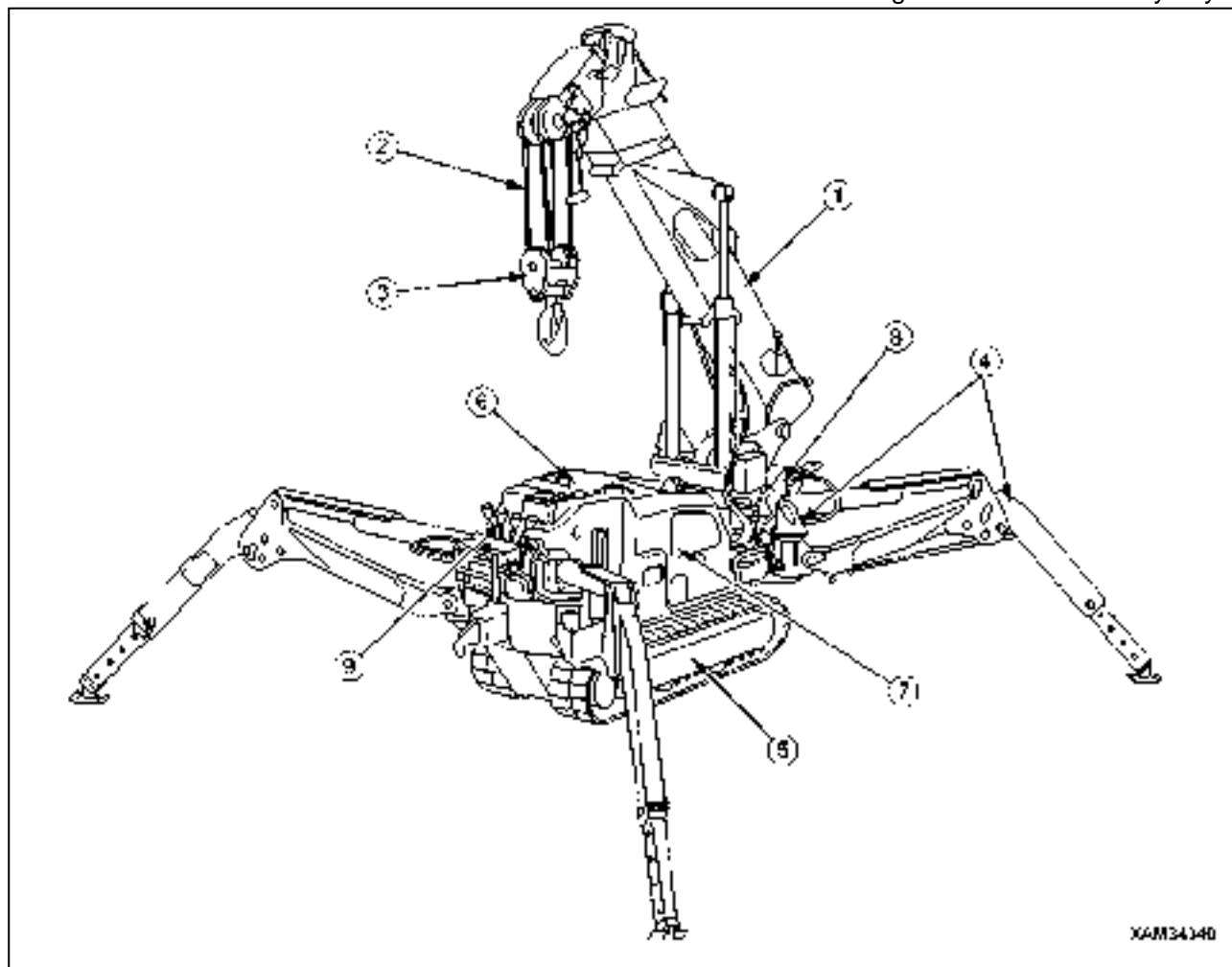

[1] CHECKING AROUND CRANE

- Look around and below the boom and post and look for any oil leak or similar. Be especially careful to check the derricking cylinder and lower part of the winch motor near the post. If you find any abnormality, repair.
- Check each part of the post for cracks, excessive deformation & contamination etc. In addition, check bolts, nuts, pins and piping joints for any looseness, drop or damage etc. Be especially careful to check for looseness of decelerator mounting bolt of the post, slewing ring or slewing device. If you find any abnormality, repair.
- Check each part of the boom for cracks, excessive deformation, contamination etc. In addition, check bolts, nuts, pins and piping joints for any looseness, drop & damage etc. Be especially careful to check for excessive abrasion and damage of the boom support pin or derrick support pin. If you find any abnormality, repair.
- Check for excessive damage and deformity of the over hoist weight wire rope of the overwinding alarm device at the tip of the boom. If there is any abnormality, repair.
- Check for sagged electrical wire, loosened connection and trace of burns. If you find any abnormality, repair.

[2] CHECKING WIRE ROPES

★ See "Inspection and Maintenance 8.6 [2] Replacement winch wire rope".

- Check the wire ropes for damage, deformation, wear, twists, kinks, corrosion, etc. If you find any abnormality, replace.
- Check the bound condition of the wire rope ends. If you find any loosened wire rope end, replace.
- Check for irregular winding of the wire ropes (wind drum). If you find any irregular winding, rewind.

[3] CHECKING HOOK BLOCK

- Verify that the wire rope latch (1) of the hook block functions normally. If there is any abnormality, repair.
- Rotate the hook and verify that the hook rotates smoothly and that trunnion does not emit any abnormal sound. If there is any abnormality, repair.
- Check the hook for any crack or excessive deformation. If there is any abnormality, repair.
- If dimension **a** between the punch marks punched on the hook became "105 mm or more" or the hook lower part dimension **b** became "49.5 mm or less", replace the hook.

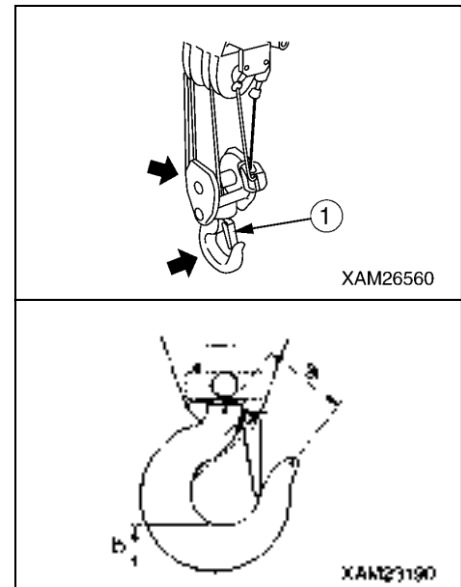

[4] CHECKING AROUND OUTRIGGERS

- Look below each of the outriggers and check for any oil leak etc. Be especially careful to check below the outrigger cylinders. If you find any abnormality, repair.
- Check each of the rotaries, outriggers, holders and outrigger cylinders for cracks, excessive deformation & contamination etc. In addition, check bolts, nuts, pins and piping joints for any looseness, drop or damage etc. If you find any abnormality, repair.
- Pull out the position pin of each of the outriggers, rotate the relevant outrigger rotary and verify that the operation is smooth. If you find any abnormality, repair.

[5] CHECKING UNDERCARRIAGE PARTS

Check each of the frames, rubber tracks, rollers, idlers and sprockets for cracks, excessive deformation & contamination etc. In addition, check bolts, nuts and pins for any looseness, drop or damage etc. If you find any abnormality, repair.

[6] CHECKING AROUND TRAVELLING DOLLY

- Look around and below the machine and check bolts, nuts, pins and piping joints for any looseness, drop or damage etc. If you find any abnormality, repair.
- Look around and below the machine and look for any oil leak or similar. Be especially careful to check below the hydraulic oil tank, travel/crane operation section and each travelling motor. If you find any abnormality, repair.
- Look around and below the Machine and check for breakage, excessive deformation, contamination etc. Also check lights such as the headlights and the working status lamp. If you find any abnormality, repair.
- Look around and below the machine and check for sagged electrical wire, loosened connection and trace of burns. If you find any abnormality, repair.
- Check each of the frames, machinery covers and other parts for cracks, excessive deformation & contamination etc. If you find any abnormality, repair.

[7] CHECKING AROUND ENGINE

- Check for fuel, oil or water leaking from the engine. If you find any abnormality, repair.
- Check the hot engine sections such as the engine muffler and around the battery for the buildup and deposit of combustibles such as dead leaves, paper wastes, dust, oil, and grease. If there is any, remove them.
- Check the starter, alternator, around battery and similar parts for sagged electrical cables, piping joints, and the trace of burn. If you find any abnormality, repair.

[8] CHECKING AROUND TRAVEL OPERATION SECTION

- Verify that all of the travelling levers, acceleration lever, travelling lever stand lock lever and travelling lever stand operate smoothly. If you find any abnormality, repair.
- Check the hour meter on the instrument panel for damages and dirtiness. If you find any abnormality, repair. If dirty, clean.
- Verify that all of the switches on the instrument panel operate smoothly. If you find any abnormality, repair.
- Check for sagging electrical wire, loosened connection and trace of burns. If you find any abnormality, repair.

[9] CHECKING AROUND CRANE OPERATION SECTION

- Verify that all of the operation levers and acceleration lever operate smoothly. If you find any abnormality, repair.
- Check the moment limiter display for damages and dirtiness. If you find any abnormality, repair. If dirty, clean.
- Verify that all of the switches on the outrigger operation panel and the instrument panel operate smoothly. If you find any abnormality, repair.
- Check for sagging electrical wire, loosened connection and trace of burns. If you find any abnormality, repair.

2.1.2 CHECKS BEFORE STARTING THE ENGINE

Check the following in this section without starting the engine and before starting work every day.

[1] CHECKING/REFILLING OIL LEVEL IN ENGINE OIL PAN

⚠ CAUTION

Securely install the oil level gauge (filler cap) after checking the oil level and refilling with the oil. If the oil level gauge falls during the operation, the hot oil spouts out of the pan, causing burns.

CAUTION

- See “Maintenance 5.1 Use of Lubricating Oil According to Temperature” for which oil to be used. Using other oil than those specified may shorten the life of the engine. Be sure to refill with the specified oil.
- Keep the engine oil at the appropriate level.
The oil level being too high will result in too much oil consumption and this tends to increase the oil temperature, deteriorating the oil faster. The oil level being too low may burn out the engine.
- Be careful not to let any foreign substance go into the filler opening when refilling with the oil.

1. Stop the machine on a level surface.
2. Pull the oil level gauge (G) out and wipe the oil with a disposable cloth.
3. Insert the oil level gauge (G) into the oil filler and pull it out.

NOTES

Don't screw in the oil level gauge (G).
That causes oil to be filled higher than correct level.

4. If the oil level is between the “H” mark and “L” mark on the oil level gauge (G), the oil level is normal.
5. If the oil level is lower than the “L” mark, refill with the engine oil from the filler opening.

NOTES

Refill the engine oil until it almost reaches the oil filler port.

6. After refilling with the oil, securely install the oil level gauge (G).

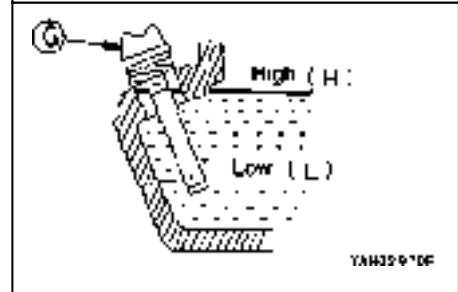
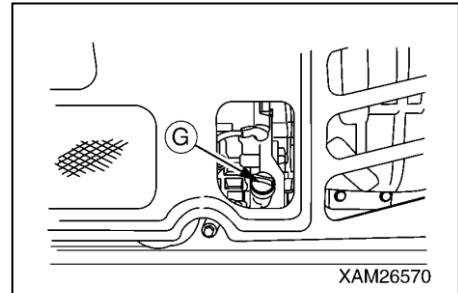

[2] CHECKING/REFUELING FUEL LEVEL IN FUEL TANK

⚠ DANGER

- This machine uses gasoline (Octane number between 89 and 92). Be extremely careful with fire such as cigarette.
- Be sure to stop the engine when refueling. If refueling was done with the engine in operation, the fuel spilled on the section where it gets hot such as muffler can catch fire.
- Over-refilling may cause fuel spill. Refuel to the level slightly lower than the specified upper limit level. If the fuel spills, be sure to thoroughly wipe it off.
- Be sure to close the tank cap after refuelling.

CAUTION

- See “Maintenance 5.1 Use of Lubricating Oil According to Temperature” for which fuel to be used.
- Be careful not to let any foreign substance enter the filler opening when refueling.

1. Looking at the fuel gauge (G) on the top of the fuel tank, check if the fuel is filled to almost full (around “F”).
2. If the fuel level is low, remove the tank cap (F) on the top of the fuel tank and refuel from the filler opening while watching the fuel gauge (G).
3. After refueling, turn the tank cap (F) to securely close it.

NOTES

Fill the fuel tank to full after finishing the work for the day.

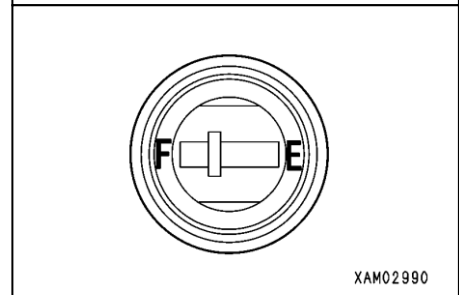
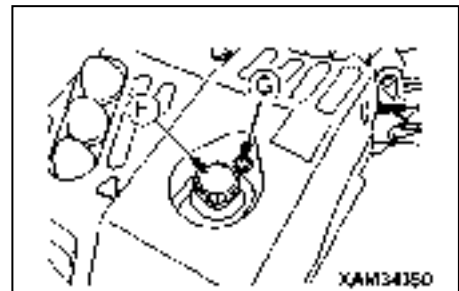

[3] CHECKING/REFILLING OIL LEVEL IN HYDRAULIC OIL TANK

⚠ WARNING

- The oil may spout out when the cap of the hydraulic oil tank is removed. Loosen the bolts so that the cap is raised a little to allow the release of inner pressure, then remove bolts and remove the cap.
- Securely tighten mounting bolts of the oil filler cap after refilling with the oil. If the mounting bolts are loose and then filler cap falls during the operation, the hot oil spouts out of the pan, causing burns. Also, when attaching the oil filler cap, always attach a rubber packing, otherwise, when the rubber packing is neglected, The hot oil may spout out of the filler cap fitting, causing burns.

CAUTION

- See “Maintenance 5.1 Use of Lubricating Oil According to Temperature” for which oil to be used.
- Be sure to put the machine in the travelling position when checking the oil level. Checking the oil level in the working position will cause overfilling since the oil in the cylinders has not returned to the tank.
- Avoid the oil exceeding the level point (red point) of the level gauge. When the oil goes beyond the correct level, it may spout out from the air breather during travelling or crane operation.
- Be careful not to let dust enter the filler opening when refilling with oil.

1. Stop the machine on a level surface.
2. Check the oil level gauge (G) in the left side of the machinery cover and ensure that oil is sufficient to reach the level point (red point).
3. If there is not sufficient oil, refill with the hydraulic oil using the following procedure.
 - (1) Remove 4 mounting bolts (1) and the filler cap (F) on the top of the hydraulic oil tank.
 - (2) Refill with the hydraulic oil from the filler opening (F) while looking at the oil level gauge (G).
 - (3) After refilling with oil, Set the filler cap (F) and rubber packing to the filler opening position and tighten mounting bolts securely.



[4] CHECKING/REFILLING OIL LEVEL IN SLEWING REDUCTION GEAR CASE

⚠ WARNING

Securely tighten the filler plug after refilling with the oil. If the filler plug falls during the operation, the hot oil spouts out of the pan, causing burns.

CAUTION

- See “Maintenance 5.1 Use of Lubricating Oil According to Temperature” for which oil to be used.
- Use seal tape, etc. at the thread of the filler plug to stop the oil leak and securely tighten the plug after refilling with the oil.

1. Stop the machine on a level surface.
2. See “Operation 1.6 Machinery Cover” to remove the machinery cover.
3. Remove 2 mounting bolts (2) and then remove the slewing gear cover (1).
4. Remove the oil filler plug (F) in the slewing reduction gear case and put your finger into the hole to check that the oil is sufficient to almost reach the plug hole mouth.
5. If the oil level is low, refill with the gear oil from the plug hole of the filler plug (F).

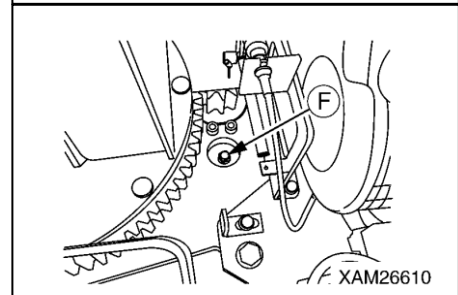
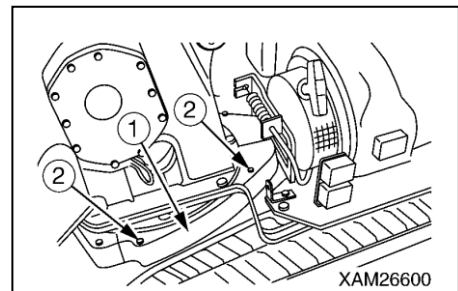

NOTES

Oil shall be refilled until it almost reaches the plug hole mouth.

6. Put in the filler plug (F) and secure it after oil checking/refilling.
7. Install the slewing gear cover (1) to the original position and tighten the 2 mounting bolts securely.
8. Install the machinery cover.
For detail, see “Operation 1.6 Machinery Cover”.

[5] CHECKING/REFILLING OIL LEVEL IN WINCH REDUCTION GEAR CASE

⚠ WARNING

- For the winch reduction gear case oil, always use "BONNOC M320 (NIPPON OIL EUROPE LIMITED)". When any oil other than as specified is used, that may cause deterioration of the winch brake capacity and result in unforeseen accidents.
- Before checking the oil level, allow the machine to get cool to the temperature where you can touch the side near the bottom of the winch reduction gear case. Otherwise, when hot oil, just after operations, comes out, it may cause burns.

CAUTION

Use seal tape, etc. at the thread of the oil level check plug to stop the oil leak and securely tighten the plug after refilling with the oil.

1. Stop the machine on a level surface.
2. Remove the oil level check plug (G) of the winch reduction gear case (1) to check if the oil will come out of the plug hole.
3. If there is not sufficient oil, remove the oil filler plug (F) and pour in gear oil at the plug hole.

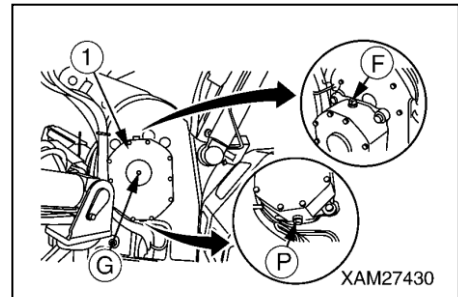

NOTES

Pour in the gear oil until the oil comes out of the oil level check plug (G).

4. Install the oil level check plug (G) and oil filler plug (F) and securely tighten them after checking and refilling with the oil.

[6] CHECKING/REFILLING OIL LEVEL IN TRAVELLING MOTOR REDUCTION GEAR CASE

CAUTION

- See "Maintenance 5.1 Use of Lubricating Oil According to Temperature" for which oil to be used.
- Use seal tape, etc. at the thread of the oil level check plug to stop the oil leak and securely tighten the plug after refilling with the oil.

1. Move the machine forward and backward so that drain plug (P) of the travelling motor reduction gear case will be at the lowest point.
2. Remove the oil level check plug (G) of the travelling motor reduction gear case to check if the oil comes out of the plug hole.
3. If there is not sufficient oil, pour in engine oil at the plug hole (G).

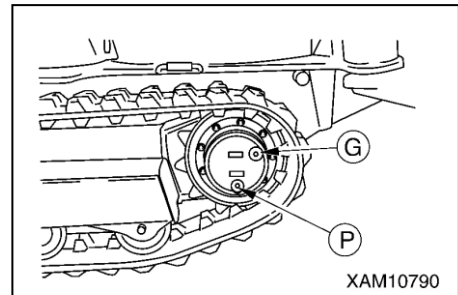

NOTES

Pour in the gear oil until the oil comes out of the oil level check plug (G).

4. Install the oil level check plug (G) and drain plug (P) and securely tighten them after checking and refilling with the oil.

[7] CHECKING/REFILLING BATTERY ELECTROLYTE LEVEL

⚠ WARNING

- The electrolyte generates combustible gas and presents explosion hazard. Do not bring any fire close to the electrolyte.
- The electrolyte is a hazardous substance. Avoid contact with eyes or skin. Should it come into the contact with eyes or skin, wash the affected area with plenty of water and consult a physician.
- Do not refill the electrolyte above the “Maximum level line”.
The fluid leakage can cause fire.

CAUTION

- Wipe the top of the battery with moistened cloth to keep it clean.
- Distilled water should be refilled before starting the work next day to avoid freezing.

[LEVEL CHECK]

1. Stop the machine on a level surface.
2. See “Operation 2.13 Outrigger Set Up Operation” to rotate the outrigger rotary of the “outrigger (3)” and “outrigger (4)” outward.
3. Verify the electrolyte you can see through the side of the battery case from the inspection hole of the machinery cover.

NOTES

Wipe the battery case clean if it is dirty.

4. Verify that the surface of the electrolyte is at the upper level line (1).
5. When the electrolyte is at the upper level line (1), see “Operation 2.23 Outrigger Stowing Operation” and rotate the outrigger rotary of the “outrigger (3)” and “outrigger (4)” inward and stow.

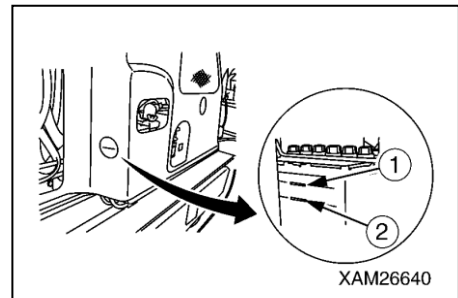

[REFILLING WITH ELECTROLYTE]

If the surface of the electrolyte is not at the maximum level line (1), refill with the distilled water using the following procedure.

1. See “Operation 1.6 Machinery Cover” to remove the machinery cover.
2. Remove the wing nut (4) and remove the rod (5) and battery holder (3).

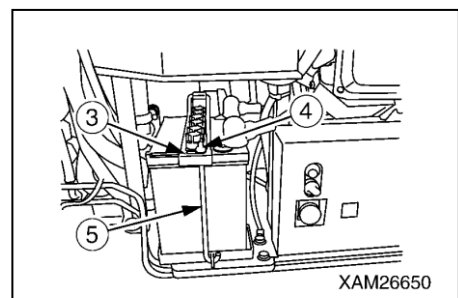

3. Pull out the battery (6) toward you and remove all the six battery caps (7) and refill with the distilled water to the maximum level line (1).

⚠ WARNING

When detaching or attaching the battery, be careful that positive (+) terminal of it would not touch any metal parts in that zone. Otherwise, battery may spark and/or explode.

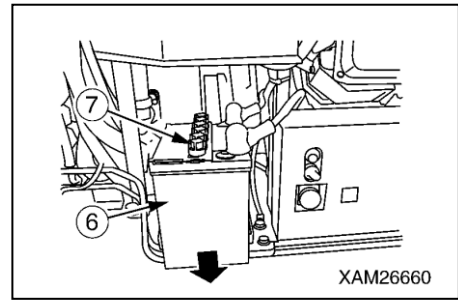

NOTES

Pour diluted sulfuric acid if you spill the electrolyte.

4. Check the ventilation hole of the battery caps (7). Clean the cap if clogged, and securely tighten the caps.
5. After refilling with the electrolyte, push the battery (6) to the original position and install the battery holder (3) and rod (5) to the original position, and securely tighten the wing nut (4).
6. See "Operation 1.6 Machinery Cover" to install the machinery cover.

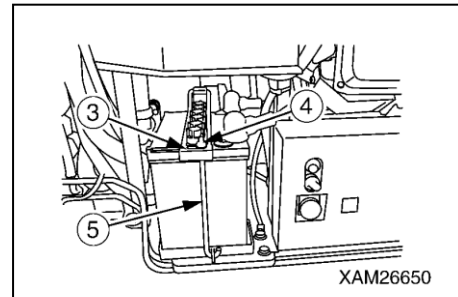

[8] CHECKING/CLEANING RECOIL STARTER

CAUTION

Clogging of the recoil starter screen may cause engine to over-heat, shortening its useful life. Make sure to check the recoil starter screen and clean it as necessary.

Check the recoil starter screen (1) through inspection hole in machinery cover to make sure that there is no deposit of dust of paper or straw or dead leaves and remove them, if any.

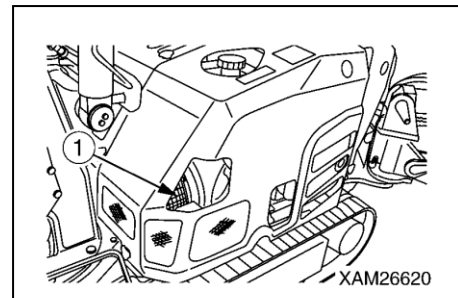

[9] CHECKING/CLEANING ENGINE EXHAUST GAS HOLE

⚠ WARNING

Deposit of dust of paper or straw or dead leaves at engine exhaust hole may constitute cause of fire. Be sure to check and keep the hole clean.

Check the engine exhaust gas hole for deposit of dust, paper, straw or dead leaves and remove them, if any.

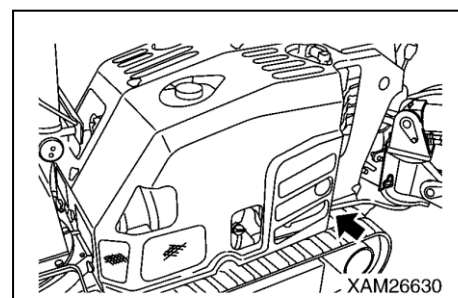

[10] CHECKING/CLEANING/REPLACEMENT AIR CLEANER ELEMENT

⚠ WARNING

Do not clean and replace the air cleaner when the engine is running.
Potential damage to the engine may occur if disregarded.

CAUTION

Always avoid using the air cleaner element in a dry condition.
Such condition allows particles or dusts to enter into the engine, resulting in a shortened engine life.
Always keep it damp by dipping the element into engine oil once, then wringing it out.

1. Put your hands into the maintenance window in the left rear side of the machine and unfasten the upper and lower holders (2) of the air cleaner cover (1).

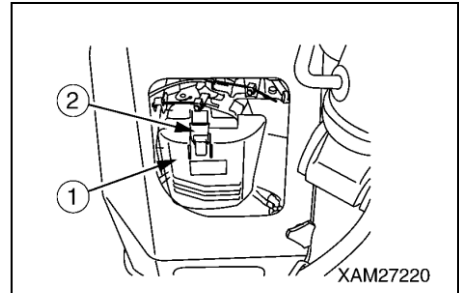

2. Take the element (3) out from the cover (1) and check that the element (sponge) is not clogged with particles or dust buildup, and that it has no tear or serious damage.

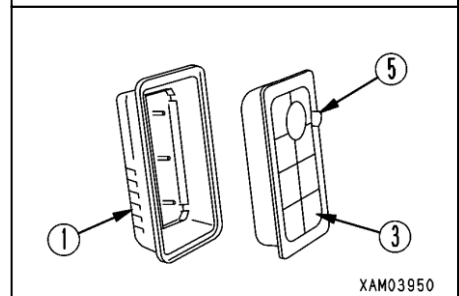

NOTES

- The element must be replaced when it has tears or serious damages.
- While the cover is off, the air intake port should be shielded with a clean cloth or tape to avoid particles or dust going into it.

3. Clean the inside of the cover (1).

4. Clean the inside of the body (4).

5. Clean the element (3) according to the practice as below:

(1) Wash the element with kerosene.

(2) When washed, squeeze kerosene out of the element thoroughly and allow it dry.

(3) Dip the element into engine oil and then squeeze engine oil out of the element tightly.

6. Set the element (3) to the cover (1).

7. Push in the cover to the body (4) and secure it with the two holders (2).

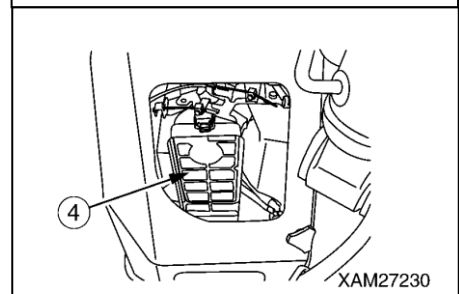

[11] CHECKING HORN FOR OPERATION

1. Turn the starter switch to the ON position and check the following.

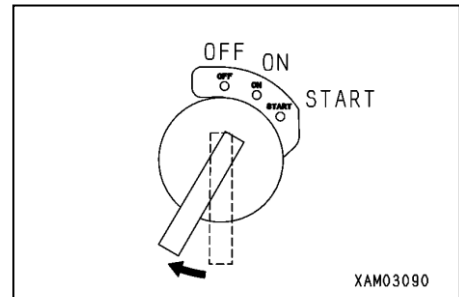

2. Press the horn switch of the top of the travelling lever stand to verify that the horn sounds.

If not, the horn may be faulty or the circuit may be open.

Ask us or our sales service agency for repair.

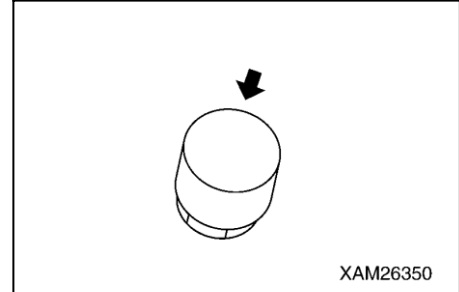

[12] CHECKING HEADLIGHTS FOR OPERATION

1. Turn the starter switch to the ON position and check the followings.

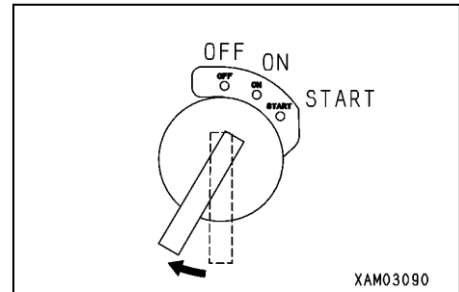

2. Pull the headlight switch and verify that the headlight on front of the machine lights up.

If it does not light up, the bulb may be burned or the circuit may be open. Ask us or our sales service agency for repair.

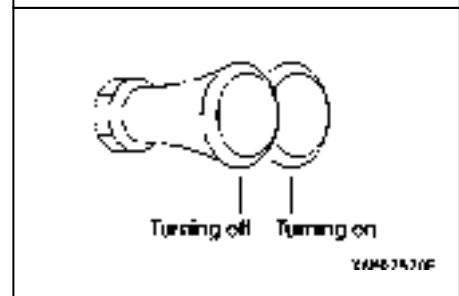

[13] CHECKING FUSE FOR DAMAGE

⚠ WARNING

If fuses are blown frequently or if you find the trace of a short circuit created in the electrical wiring, be sure to find the cause and fix the problem.

1. Turn the fuse holders (3) on control panel counterclockwise and take tubular fuses out.

2. Check the fuse for damage and meltdown and if the fuse of the specified capacity is being used.

3. If a fuse has melted down or the trace of an open/short circuit is found in the electrical wiring, ask us or our sales service agency for repair.

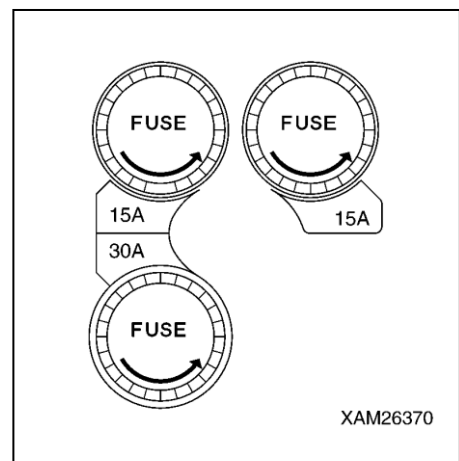

2.1.3 CHECKS AFTER STARTING THE ENGINE

Check the followings in this section after starting the engine and before starting work every day.

CAUTION

The checks described in this section should be carried out after starting the machine. Refer to "Operation 2.2 Starting the Engine" and later to execute the engine startup, travelling operations, outrigger operations and crane operations.

[1] CHECKING/ADJUSTING RUBBER TRACK TENSION

CAUTION

- Set the outriggers and raise the rubber track for about 50 mm from the ground when checking/adjusting the tension of the rubber tracks.
- The standard tension of the rubber track is that the clearance between the wheel tread of the track roller at centre and the shoulder of the rubber track is 5 to 10 mm.
- If the tension is not sufficient even after injecting the grease, the rubber track or the sealing of the tension adjustment cylinder needs to be changed. Contact us or our sales service agency for the judgement of whether to replace, repair, or keep the rubber track.

The rubber tracks are worn out differently depending on the working conditions and ground quality. Regularly check the wear and tension of the rubber tracks.

Especially, with the new machine or when a new part was installed, "initial slack" appears with 5 to 30 hours of driving after adjusting the tension to the specified value.

Adjust the tension frequently until the period of "initial slack" passes. This will prevent "rubber track from coming off due to insufficient tension on the rubber track".

[TENSION CHECK]

1. Move the left and right crawlers so that the junction of the rubber track (indicated by M) comes to the top centre between the axles.

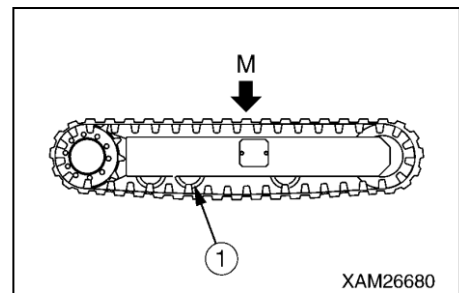

2. See "Operation 2.13 Outrigger Set Up Operation" to set the outriggers and raise the crawlers for About 50mm from the ground.

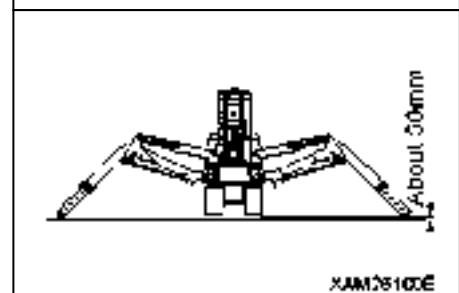

3. Measure the clearance between the wheel tread of the track roller at centre and the shoulder of the rubber track.

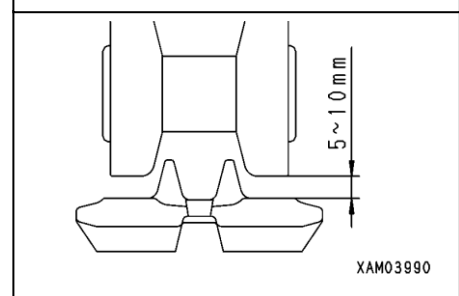

NOTES

The clearance of 5 to 10 mm indicates the standard tension.

4. If the tension is out of the standard range, see the section of tension adjustment on the next page to make adjustments.

[TENSION ADJUSTMENT]

If the “tension check” of the rubber track found the tension lower than standard tension of the rubber track, make adjustments as described below.

Working with the loose rubber track (the tension of the rubber track at 15 mm or more) will cause run-off or early wear of the core metal.

• LOOSE TENSION (INCREASE TENSION)

- Have a grease gun (pump) ready.

1. Remove the 2 bolts (2) and then remove inspection cover (1).

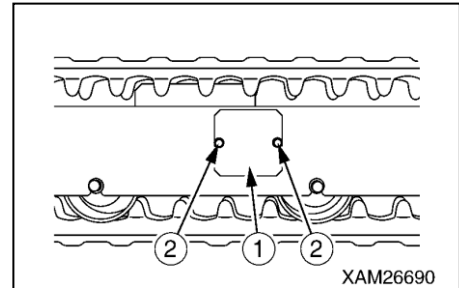

2. Inject the grease from the grease nipple (3) using the grease gun.

3. Perform the following tasks to verify the proper tension.

- (1) See “Operation 2.23 Outrigger Stowing Operation” to stow the outriggers and lower the machine on the ground.

- (2) Move the machine forward/backward.

- (3) See “Operation 2.13 Outrigger Set Up Operation” to set the outriggers and raise the crawlers again for about 50mm from the ground.

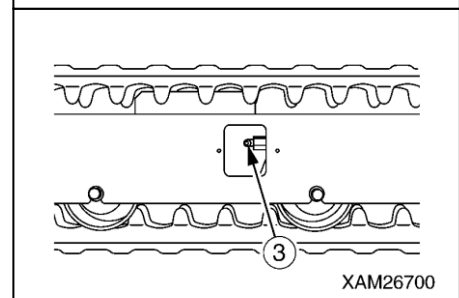

4. Perform the “tension check” of the rubber track again.

If the tension is not appropriate, make another adjustment.

5. Install the inspection cover (1) to the original position and tighten 2 mounting bolts (2).

6. See “Operation 2.23 Outrigger Stowing Operation” to stow the outriggers and lower the machine on the ground.

• TIGHT TENSION (DECREASE TENSION)

⚠ WARNING

Inside the rubber track tension adjustment device, the grease is sealed. The grease is under high pressure due to the tension of the rubber track.

Making adjustments without observing the followings may cause the grease valve to fly away, resulting in serious accidents.

- Do not loosen the grease valve for tension adjustment more than 1 turn. The grease valve may pop out.
- Do not place yourself right in front of the grease valve when adjusting the tension to avoid any danger.

1. Remove the 2 bolts (2) and then remove inspection cover (1).

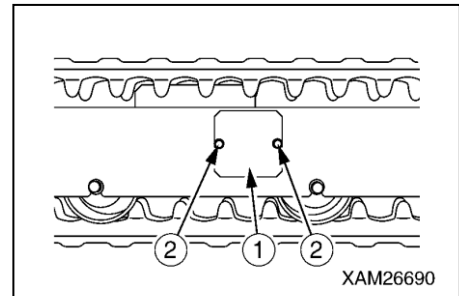

2. Slowly loosen the grease valve (4) to drain the grease.

NOTES

When loosening the grease valve (4), do not loosen more than one turn.

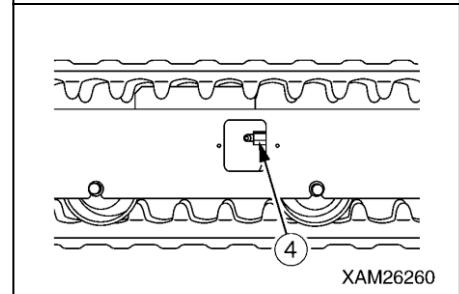

3. If the grease is not drained easily, perform the following to drain the grease.

- (1) See "Operation 2.23 Outrigger Stowing Operation" to stow the outriggers and lower the machine on the ground.
- (2) Move the machine forward/backward.
- (3) See "Operation 2.13 Outrigger Set Up Operation" to set the outriggers and raise the crawlers again for about 50mm from the ground.

4. Tighten the grease valve (4).

5. Perform the "tension check" of the rubber track.

If the tension is not appropriate, make another adjustment.

6. Install the inspection cover (1) to the original position and tighten 2 mounting bolts (2).

7. See "Operation 2.23 Outrigger Stowing Operation" to stow the outriggers and lower the machine on the ground.

[2] CHECKING RUBBER TRACKS FOR DAMAGE AND WEAR

CAUTION

Contact us or our sales service agency for determining whether to replace, repair, or keep the rubber track.

The following condition requires the repair or replacement of the rubber track. Ask us or our sales service agency for repair/replacement.

[LUG HEIGHT]

- When the lug height “a” decreases with wear, the traction force drops.
Replace the rubber track when the lug height decreases to 5 mm or lower with a new rubber track.

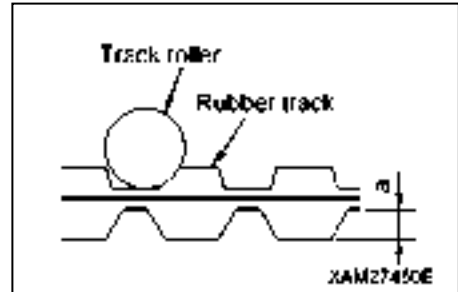

- When the lug is worn out and the steel cord inside the rubber track is exposed for more than 2 links, replace the rubber track with a new one.

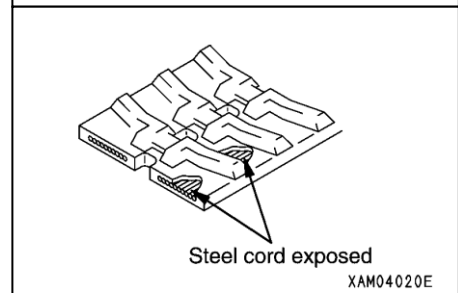

[BROKEN STEEL CORD]

- If more than half of the steel cord layer is broken on one side, replace the rubber track with a new one.

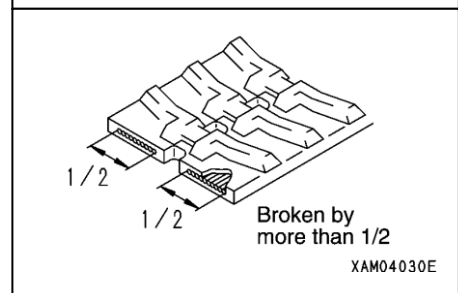

[FALLEN CORE METAL]

- If the core metal of the rubber track has fallen out at more than 1 location, change the rubber track with a new one.

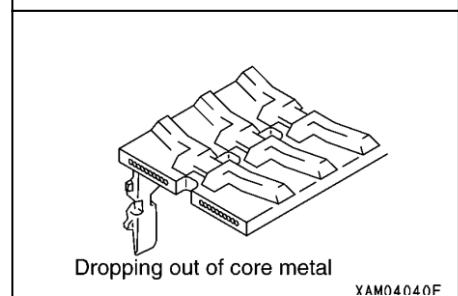

[CRACKS]

- If there is a crack between rubber track lugs, change the rubber track with a new one.

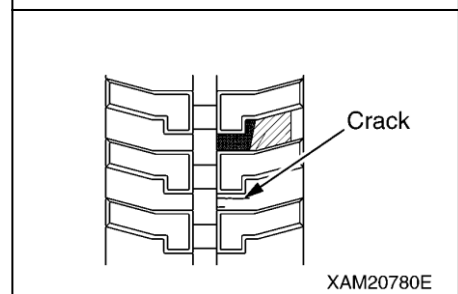

[3] CHECKING OUTRIGGER OPERATION

⚠ WARNING

Be sure to refer to "Operation 2.13 Outrigger Set Up Operation" and "Operation 2.23 Outrigger Stowing Operation", and strictly observe the methods described and cautions given when checking operations of the outriggers.

1. See "Operation 2.13.2 Outrigger Set Up Operation [1] Tasks to be Performed Upon Engine Stop" to rotate the outrigger rotary of all the outriggers outward, and pull out the inner boxes.

2. See "Operation 2.2 Starting the Engine" to start the engine.

3. Check whether the outrigger lowers smoothly when one of the Outrigger individual setting switches (15) is turned to "OUT". Also, check whether the outrigger rises smoothly when that Outrigger individual setting switches (15) is turned to "IN". During the operation, check whether any abnormal sound is made.

Continue the same checking for rest of Outrigger individual setting switches accordingly.

4. Check whether the 4 outriggers lower smoothly when the Outrigger collective setting switches (16) is turned to "OUT". Also, check whether the outriggers rise smoothly when the Outrigger collective setting switches (16) is turned to "IN". Any improper conditions where 4 outriggers don't work, for instance, are perceived, each switch or valve may be damaged or any of wiring is disconnected.

Please contact us or our service agency for services.

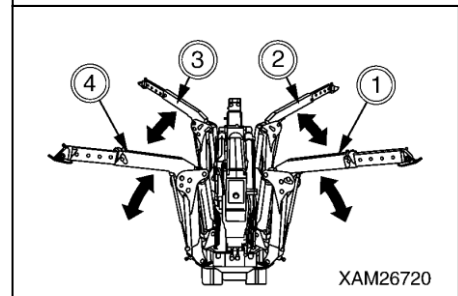
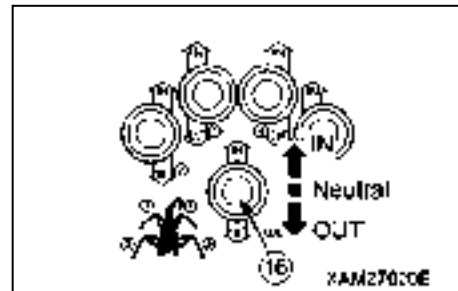
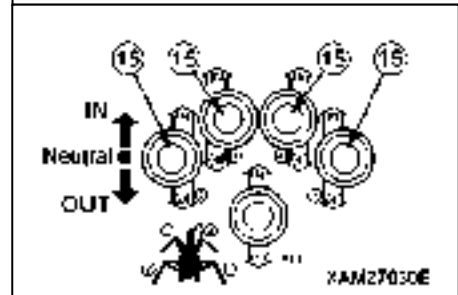
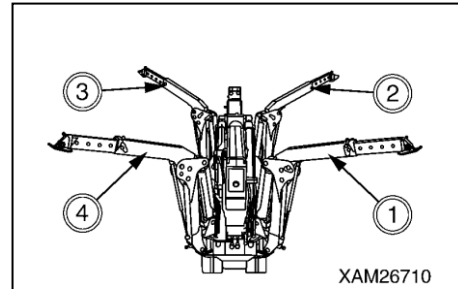

[4] CHECKING CRANE OPERATIONS

⚠ WARNING

Be sure to set the outriggers at the maximum extension state by referring to " Operation 2.13 Outrigger Set Up Operation" before checking the crane operations.
Be sure to refer to the Operation sections between "2.14 Cautions before Crane Operation" and "2.23 Crane Stowing Operation", and strictly observe the methods described and cautions given when checking crane operations.

1. Refer to "Operation 2.15 Operations before Crane Operations" and slacken the wire rope which fixes the hook block (10) to release it from the hook holder (9), according to the procedure for it.
2. Verify that the boom rises smoothly when the boom derricking lever (4) is operated to "RAISE" side (pull toward you). Also, verify that the boom lowers smoothly when the boom derricking lever (4) is operated to "LOWER" side (push forward). When doing the above, check for any abnormal sound emitted by part of the boom or from the boom derricking cylinder. If there is any abnormality, repair.
3. Verify that the boom extends smoothly when the boom telescoping lever (2) is operated to "EXTEND" (push forward). Also, verify that the boom retracts smoothly when the boom telescoping lever (2) is operated to "RETRACT" (pull toward you). When doing the above, check for any abnormal sound emitted by part of the boom or from the boom telescoping cylinder. If there is any abnormality, repair.
4. Verify that the hook is wound down smoothly when the winch lever (3) is operated to "DOWN" (push forward). Also, verify that the hook is wound up smoothly when the winch lever (3) is operated to "UP" side (pull toward you). When doing the above, check for any abnormal sound emitted by part of the boom or from the winch motor. If there is any abnormality, repair.
5. Verify that the crane smoothly slews counterclockwise when the slewing lever (1) is operated to "LEFT" side (push forward). Also, verify that the crane smoothly slews clockwise when the slewing lever (1) is operated to "RIGHT" side (pull toward you). When doing the above, check for any abnormal sound emitted nearby the post. If there is any abnormality, repair.

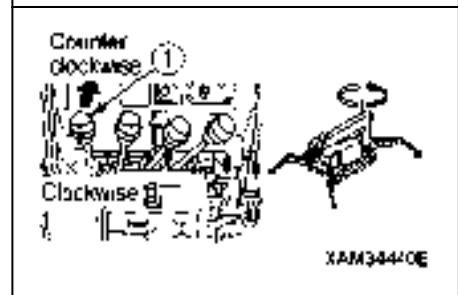
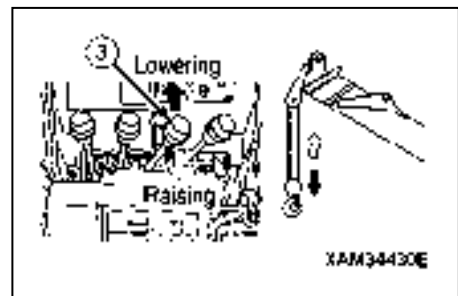
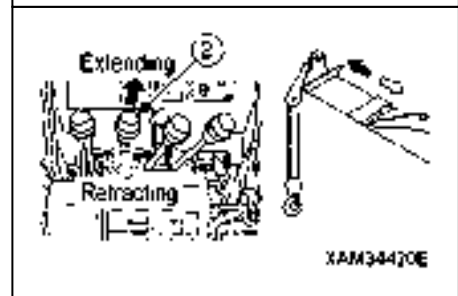
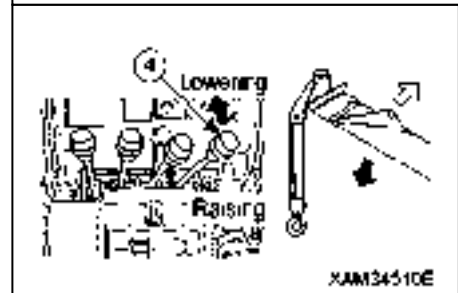
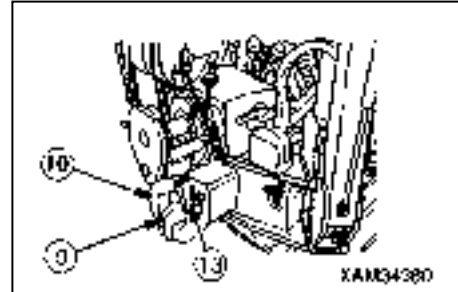

[5] CHECKING OVER HOIST DETECTOR FOR OPERATION

⚠ WARNING

- Before checking "over hoist detector for operation" is started, refer to "Operation 2.13 Outrigger Set Up Operation" and install the outriggers at the maximum position according to the procedure in it.
- For checking over hoist detector for operation, refer to "Operation 2.14 Cautions before Crane Operation" through "Operation 2.22 Crane Stowing Operation" and strictly follow their procedures and/or cautions.

1. Refer to "Operation 2.15 Operations before Crane Operations" and slacken the wire rope which fixes the hook block (10) to release it from the hook holder (9), according to the procedure in it.

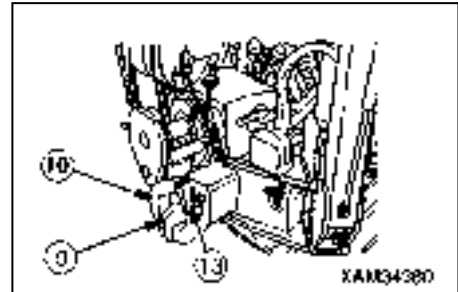

2. Keep the lever (4) of the over hoist detector (3) in its "Raise" position and try operations as listed below to ensure that each operation stops, as well as the Over hoist and moment limiter alarm buzzer beeps:

- (1) Boom derricking lever "Raise" operation.
- (2) Winch lever "UP" operation.
- (3) Boom telescoping lever "Extending" operation.

Where the over hoist and moment limiter alarm buzzer (5) does not beep or each crane function does not stop, device error of the over hoist detector or disconnection of wiring is assumed.

Ask us or our sales service agency for repair.

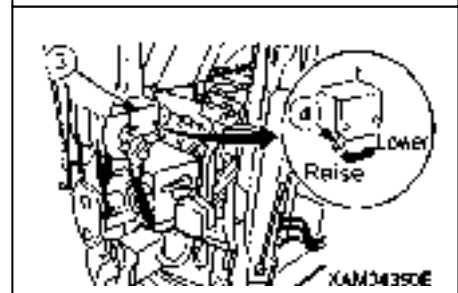

3. Keep the lever (4) of the over hoist detector (3) in its "Lower" position and try operations as listed below to ensure that the Over hoist and moment limiter alarm buzzer (5) stops beeping and each operation resumes.

Where the over hoist and moment limiter alarm buzzer (5) does not stop beeping or each crane function is not enabled, device error of the over hoist detector or disconnection of wiring is assumed.

Ask us or our sales service agency for repair.

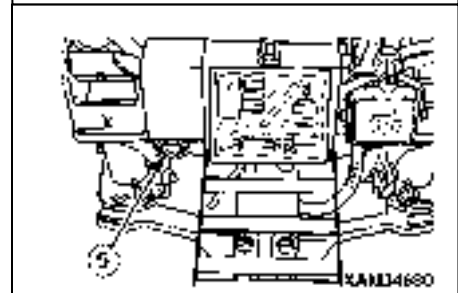

[6] CHECKING MOMENT LIMITER FOR OPERATION

⚠ WARNING

If you find any abnormality with the moment limiter, immediately contact us or our sales service agency.

1. Turn the starter switch to the ON position.
2. Check with the working status lamp. The red of the lamp lights up for 2 seconds and then the green lights up.
3. Check the moment limiter display unit.
Verify that no error code is displayed at the "RATED TOTAL LOAD" display on the display panel.
4. Start the engine and operate the crane as follows to verify if the moment limiter properly displays the value.

Crane Operation and Displayed Parameter	Value Displayed on Moment Limiter
Displayed "boom length" with the boom length at minimum	1.8 m
Displayed "boom length" with the boom length at maximum	5.5 m
Displayed "working radius" with the boom length of "2.9 m" (2-row booms) and boom angle of "55.5 degrees "	1.5 ± 0.1 m
Displayed "ACTUAL LOAD" when the weight of the known weight was hoisted ★ Must be equal to the total weight of weight + lifting ring ★ Note that it may show some errors depending on the boom conditions. ★ Operate the crane until the moment limiter display values indicate the boom length is "2.9 m" (2-row booms) and boom angle is "55.5 degrees", then measure the "boom angle" and "working radius". If the measured value(s) differ from the moment limiter display value, contact us or our sales agency.	Actual load

[7] CHECKING ENGINE EMERGENCY STOP SWITCH FOR OPERATION

(For both Travelling Operation Unit and Crane Operation Unit)

Push the Engine emergency Stop Switch and ensure that the engine stops.

When the engine does not stop, error of the switch or disconnection of wiring is assumed. Ask us or our sales service agency for repair.

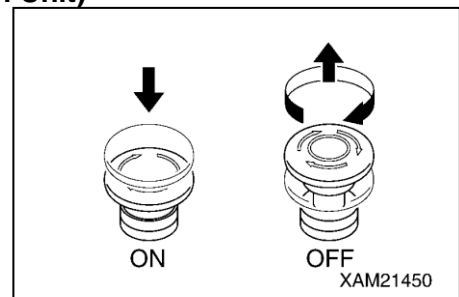

NOTES

When restarting the engine after emergency stop, be sure to turn the engine emergency stop switch to the OFF position before starting the engine. The engine does not start when it is "ON".

[8] CHECKING ENGINE EXHAUST GAS COLOR, NOISE AND VIBRATION

1. Set the acceleration lever of either Travel Operation Unit or Crane Operation Unit to low idling position so that the engine is kept in no load operation for 5 minutes.
2. Verify that the engine exhaust gas colour is either transparent or slightly blue. Also, check for abnormal noises and vibrations.
If there is any abnormality, repair.

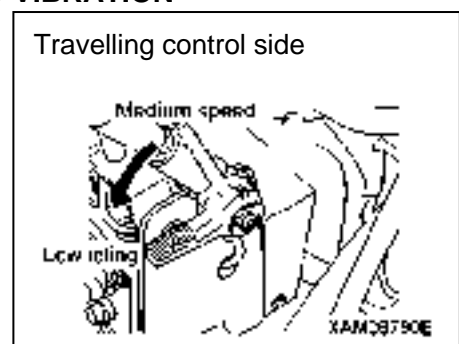

2.2 STARTING THE ENGINE

⚠ DANGER

Never refuel (gasoline) while the engine is in operation. Always stop the engine when refuelling.

⚠ WARNING

Verify that there is no one or obstacles around when starting the engine. Honk the horn and start the engine.

2.2.1 NORMAL ENGINE START

CAUTION

- Do not keep the starter turned for more than 5 seconds. Doing so will accelerate the battery discharge.
Wait for about 1 minute before attempting to start the engine again if it did not start.
- Even in normal temperature, pull the choke knob toward you.
- Verify that the fuel lever of the water separator pot is at the vertical position (open) before starting the engine.
- Make sure that the engine emergency stop switch is in OFF position. The engine does not start when it is "ON".
- Verify that the main switch on the remote control receiver is at the OFF position.

1. Push the acceleration lever forward to operate the engine at medium speed (lever stroke about midway).

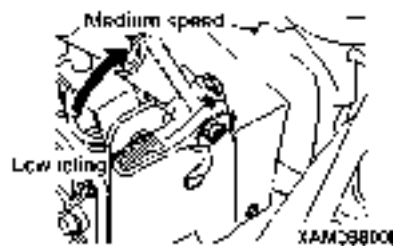

2. Pull the choke knob toward you.

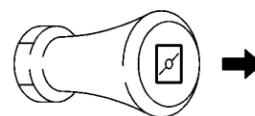

XAM02560

3. Insert the key into the starter switch and turn the key to the START position.

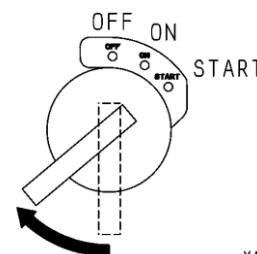

XAM03120

4. Release your hand from the key once the engine has started. The key will automatically return to the ON position.

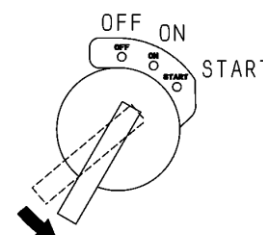

XAM03130

5. Push the choke knob forward to return the original position.

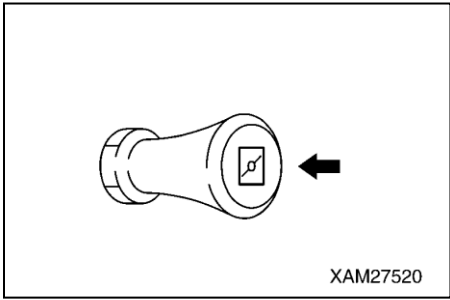

2.2.2 STARTING THE ENGINE WITH AUXILIARY STARTER SWITCH

CAUTION

- To start the engine with the auxiliary starter switch, make sure that the main starter switch is in ON position.
- Do not keep the starter turned for more than 5 seconds. Doing so will accelerate the battery discharge.
Wait for about 1 minute before attempting to start the engine again if it did not start.
- Even in normal temperature, pull the choke knob before starting the engine, as a rule.
- Verify that the fuel lever of the water separator pot is at the vertical position (open) before starting the engine.
- Make sure that the engine emergency stop switch is in OFF position. The engine does not start when it is "ON".
- Verify that the main switch on the remote control receiver is at the OFF position.

1. Insert the key into the main starter switch and turn the key to the ON position.

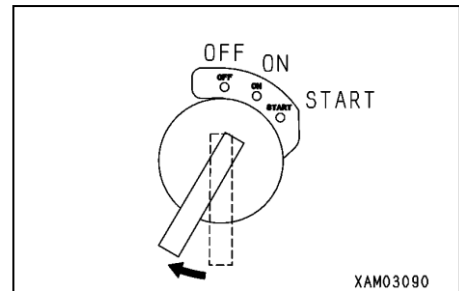

2. Pull the choke knob toward you.

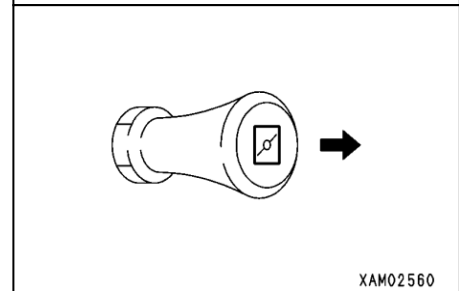

3. Move forward to the Crane Operation Unit.

4. Turn the acceleration lever toward left to operate the engine at medium speed (lever stroke about midway).

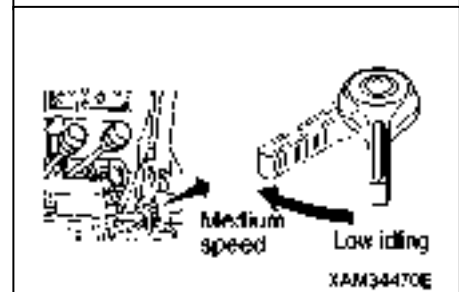

5. Push up the auxiliary starter switch to the "START" position (upward).

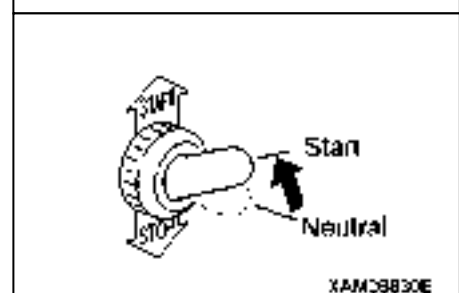

6. Release your finger from the auxiliary starter switch once the engine has started.

The auxiliary starter switch will automatically return to the NEUTRAL position.

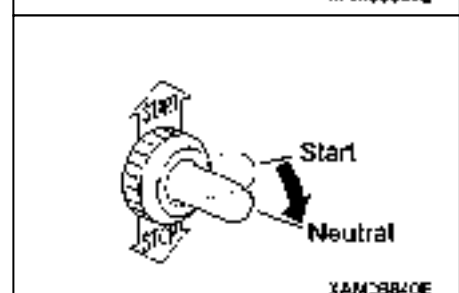

7. Move back to the Travelling Operation Unit.

8. Push the choke knob forward to return the original position.

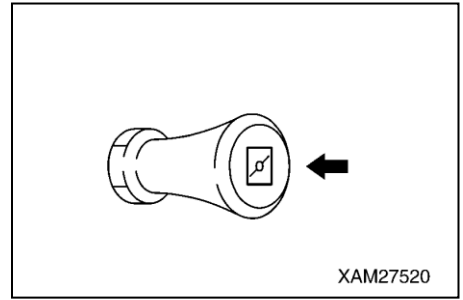

2.2.3 STARTING THE ENGINE WITH RECOIL STARTER

CAUTION

- The purpose of the Recoil starter is only for an emergency where the electrical system breaks down; e.g. the the starter does not work or the battery is discharged. Avoid using it when any abnormality is not perceived.
- To start the engine with the recoil starter, make sure that the main starter switch is in ON position.
- Even in normal temperature, pull the choke knob before starting the engine, as a rule.
- Verify that the fuel lever of the water separator pot is at the vertical position (open) before starting the engine.
- Make sure that the engine emergency stop switch is in OFF position. The engine does not start when it is "ON".
- Verify that the main switch on the remote control receiver is at the OFF position.

1. Push the acceleration lever forward to operate the engine at medium speed (lever stroke about midway).

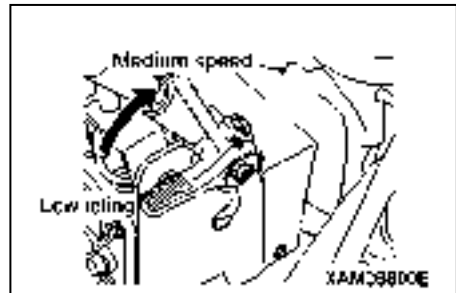

2. Insert the key into the main starter switch and turn the key to the ON position.

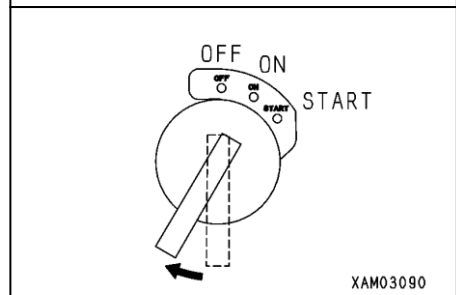

3. Pull the choke knob toward you.

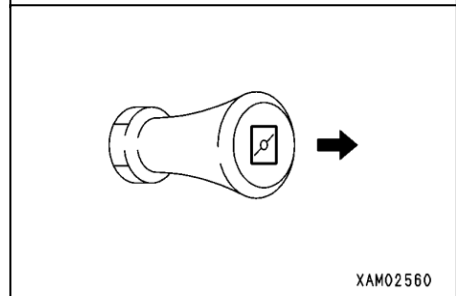

4. Pull the recoil starter knob (1) slowly toward you until you feel it becomes heavier to pull (where the starter claw fits), then draw the knob (1) quickly from that position.

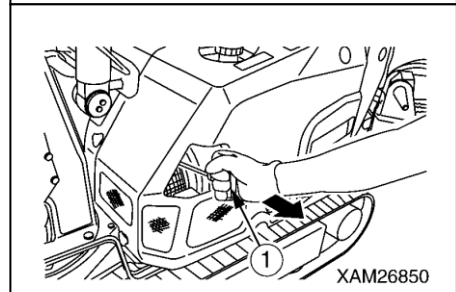

5. When the engine starts, return the recoil starter knob (1) slowly to the original position.

6. Push the choke knob forward to return the original position.

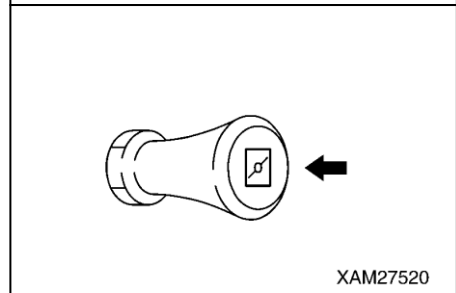

2.3 OPERATIONS AND CHECKS AFTER STARTING THE ENGINE

⚠ DANGER

Never refuel (gasoline) while the engine is in operation. Always stop the engine when refueling.

⚠ WARNING

- If any abnormal condition takes place during the warm-up operation, immediately press the engine emergency stop switch to stop the engine for emergency. Then, turn the starter switch to the OFF position. The power to the electrical system will be shut off.
- Always perform the warm-up operation. The sufficient warm-up operation is necessary particularly when it is cold.
Insufficient warm-up operation will slow down the movement response of the travelling system or crane system to the operation levers, resulting in serious accidents.
- Always check the operation of the crane after warm-up operation.
Be careful not to let the hook block interfere or collide with the boom.
- If you find any abnormality during the crane operation check, immediately press the engine emergency stop switch at the crane operating side to stop the engine for emergency. Then, turn the starter switch at the travelling operating side to the OFF position. The power to the electrical system will be shut off. After stopping the machine immediately for emergency and repair. Using the system in abnormal condition can result in serious accidents.

CAUTION

- The appropriate temperature of the hydraulic oil is 50 to 80 °C.
Even when operating at low temperature by necessity, increase the temperature of the hydraulic oil to about 20 °C.
- Do not idle away suddenly until the warm-up operation is done.
- When the engine has started, check if the “battery charge lamp” went off. If this is any abnormality, repair.
- Where the operation in low revolution of the engine prolongs too much, that may cause in-sufficient lubrication of the engine cylinder head and may result a breakdown. When it is required to operate the engine in low revolution, the engine should be idled for around 5 minutes per day.

Perform the warm-up operation as follows once the engine has started.

1. Pull the acceleration lever toward you. Keep the engine idling and continue the operation with no load for about 5 minutes.
2. Check if there is any abnormality with the engine exhaust gas color, noise, and vibration.
If there is any abnormality, repair.
3. Pull up the lock lever (6) before pressing the whole lever stand (7) down to the "Crane Operation Position", then release the lock lever (6).
4. See “Operation 2.13 Outrigger Set Up Operation” and set the outriggers.

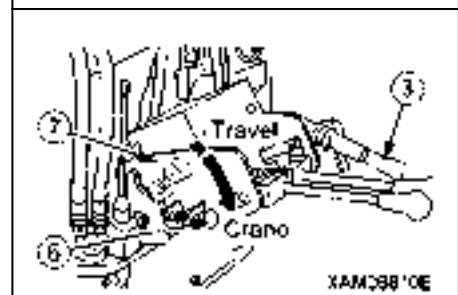
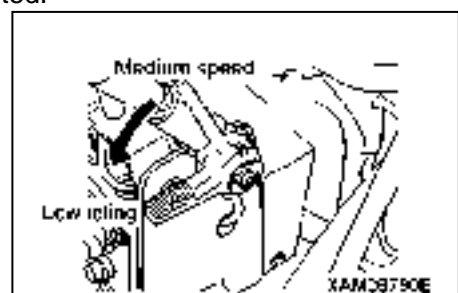

5. Refer to "Operation 2.15 Operations before Crane Operations" and slacken the wire rope which fixes the hook block (10) to release it from the hook holder (9), according to the procedure for it.

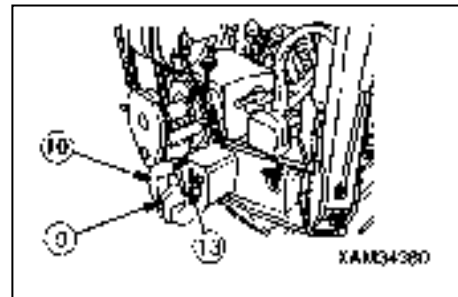

6. Turn the acceleration lever toward left to operate the engine at medium speed (lever stroke about midway).

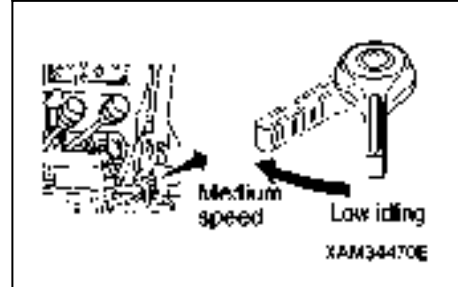

7. Operate the boom derricking lever (4) slowly forward/backward and move the derricking cylinder up/down until it reaches the stroke end. Check if there is any abnormality with the operation. If there is any abnormality, repair.

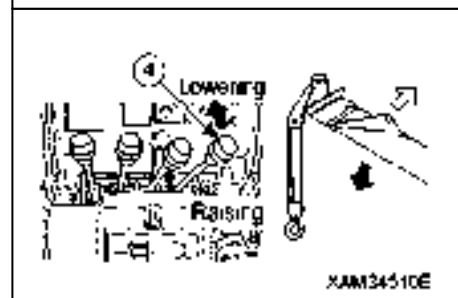

8. Operate the boom telescoping lever (2) slowly forward/backward to extend/retract the boom until it reaches the stroke end. Check if there is any abnormality with the operation. If there is any abnormality, repair.

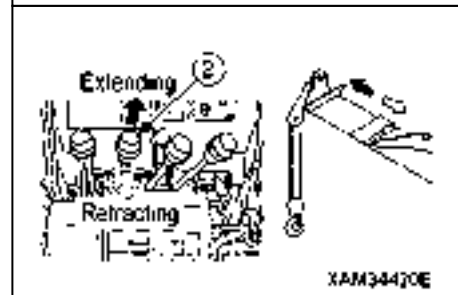

9. Operate the winch lever (3) slowly forward/backward to check if the hook block is smoothly raised/lowered. Also check if the hook block immediately stops and the winch drum does not wind into a mess when the winch lever returns to the NEUTRAL position. If there is any abnormality, repair.

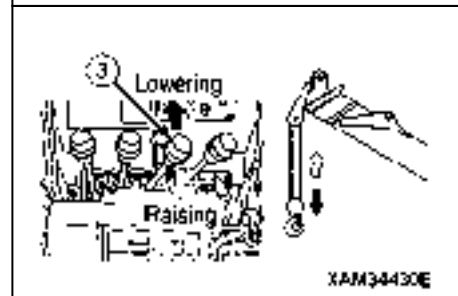

10. Operate the slewing lever (1) slowly forward/backward to check if the crane smoothly slews clockwise and counter clockwise for 360 degrees or more. Also check if the crane stops immediately when the slewing lever returns to the NEUTRAL position. If there is any abnormality, repair.

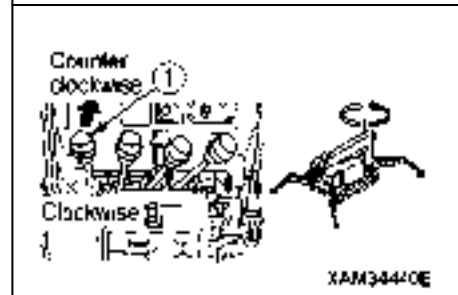

2.4 BREAKING-IN MACHINE

⚠ CAUTION

Perform breaking-in for the period of about the first 250 hours (hours displayed on the service meter).

The life of the machine shortens if overloaded operations or tasks are performed before the various sections of the machine are used (run in) to the operation.

While this machine is shipped after thorough adjustment and inspection, forcing the machine from the beginning will quickly degrade the functions of engine and crane, shortening their life.

Perform the breaking-in for the first “250 hours” (time displayed on the service meter).

Pay attention particularly to the following during the breaking-in period.

- Be sure to perform the warm-up operation and avoid idling away after the engine has started. See “Operation 2.3 Operations and Checks after Starting the Engine”
- Avoid overloaded operation or tasks with high-speed operation.
- Avoid sudden starting, sudden acceleration, unnecessary sudden stop or sudden steering
- When the breaking-in period reaches “25 hours”, do not fail to change the engine oil. See “Maintenance 8.2 [1] Replacement Engine Lubricating Oil”.

The metal powder produced inside the engine through breaking-in increases in the engine oil and it deteriorates the oil, shortening the engine life.

2.5 MACHINE TRAVELLING POSITION

⚠ WARNING

- When moving this machine self-propelled, take the “Travelling position” with which the boom, hook block, and outriggers are stowed.
- Travelling or travelling with a load hoisted with the boom extended is essentially prohibited. This will overturn the machine, causing serious injury accidents.
- Do not use this machine for any other purpose other than as detailed in this manual. Do not carrying the load on the machine.
- Follow the local laws and regulations if driving the machine on public roads.

Take the travelling position shown on the right when moving the machine.

1. See “Operation 2.22 Crane Stowing Operation” to stow the crane. Stow the hook block in the specified position.
2. See “Operation 2.23 Outrigger Stowing Operation” to stow the outriggers.

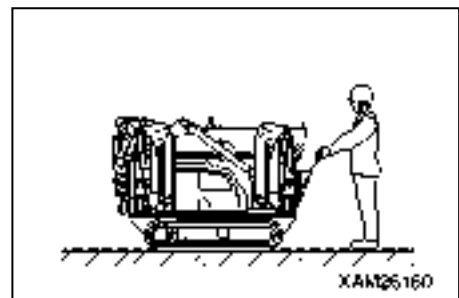

2.6 STARTING MOVING THE MACHINE

⚠ WARNING

- Do not allow anyone around the machine.
- Clear away all the obstacles on the travelling path.
Check for projections and grooves on the travelling path especially when going backward. Fix the travelling path.
- Check the safety around the machine and honk the horn before starting to move the machine.
- This machine is designed that the person who operates it should move along with it, when the machine starts travelling. Set the engine speed to low and operate the left and right travelling levers slowly at the same time. Check the travelling speed of the machine.
Do not make a sudden start especially when you are going backward. You can cause serious accidents.
- The front of the machine will be the out of view. Be extremely careful when moving forward.
- If you cannot verify the safety because the driving direction is out of view, stop driving and check if it is safe in the travelling direction. Use a guide person if necessary depending on the work site situation.,
- The whole lever stand (7) can be folded. To start travelling, pull up the lock lever (6) before erecting the entire lever stand (7) forward to the "Travelling Control Position", then fit the lock lever (6) into the guide groove.

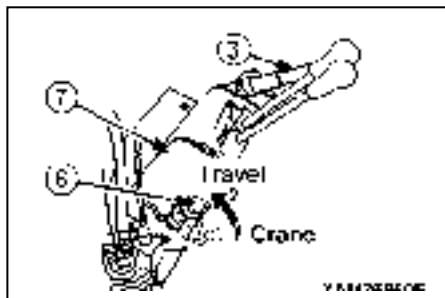

[PREPARATION BEFORE STARTING MOVING]

[1] MOVING FORWARD

Operate the left and right travelling levers at the same time.

- Push the left and right travelling levers slowly forward to move forward.

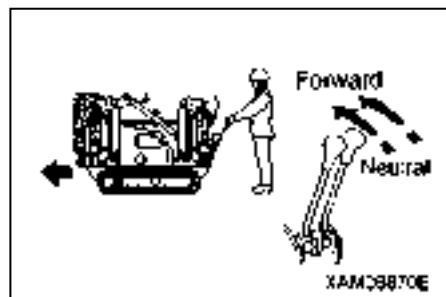

[2] MOVING BACKWARD

Operate the left and right travelling levers at the same time.

- Pull the left and right travelling levers slowly toward you to move backward.

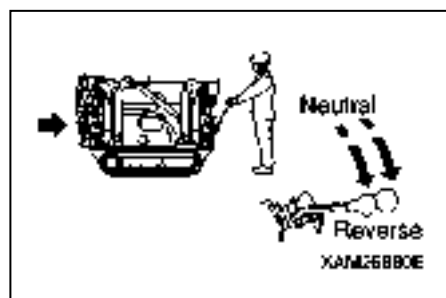

2.7 CHANGING MACHINE TRAVELLING MODE

⚠ WARNING

- Choose the appropriate travelling speed for the ground and road surface conditions while driving the machine.
You can operate the travelling levers or choose “high-speed travelling mode” or “low-speed travelling mode” with the operation position of the travelling high-speed switch to change the travelling speed.
- Always set the travelling high-speed switch to the “OFF” (low speed) when driving on a slope. Driving on the slope in the high-speed travelling mode may cause overrun on the downward slope.
- Be sure to stop the machine before changing the travelling speed mode.

[1] CHANGING TRAVELLING SPEED MODE

Operate the travelling high-speed switch on the top of the travelling stand.

- Push up the travelling high-speed switch to the ON (high speed) position (forward). The machine will be in the “high-speed travelling mode”.
- Push down the travelling high-speed switch to the OFF (low speed) position (toward you). The machine will be in the “low-speed travelling mode”.

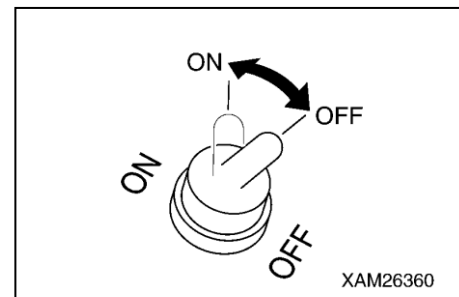

2.8 CHANGING DIRECTION OF THE MACHINE

⚠ WARNING

- Sudden steering or unnecessary spin turns at high speed not only damages the rubber track and hydraulic devices, but also may result in a collision with other objects.
Stop the machine, then adjust the engine speed to low speed before performing the spin turns.
- Do not change the path on the slope. The machine may slip to the side. Be especially careful on the soft ground and clay soil.

CAUTION

- When the path of the machine is changed, it may show serious rolling due to resonating. In such an event where rolling is amplified, reduce the travel lever functions (stroke) or release them to the NEUTRAL position.
- You may find difficulty in changing the direction of the machine in its high-speed travelling mode. In such event turn OFF the travelling high speed switch and change to low-speed travelling mode.

[1] CHANGING THE MACHINE DIRECTION WHEN STOPPED

• LEFT TURN

Operate the right travelling lever.

Tilt the travelling lever forward to turn to the left in the forward direction. Tilt the travelling lever toward you to turn to the left in the backward direction.

• RIGHT TURN

Operate the left travelling lever.

Tilt the left travelling lever forward to turn to the right in the forward direction. Tilt the left travelling lever toward you to turn to the right in the backward direction.

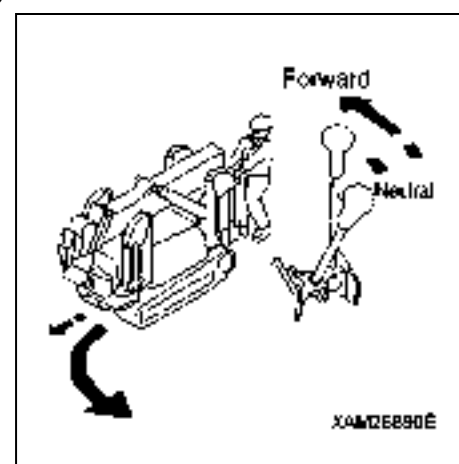

[2] SPIN TURNS

• LEFT SPIN TURN

Tilt the right travelling lever forward while tilting the left travelling lever toward you to rotate the left and right rubber tracks in the opposite direction for left spin turn.

• RIGHT SPIN TURN

Tilt the left travelling lever forward while tilting the right travelling lever toward you to rotate the left and right rubber tracks in the opposite direction for right spin turn.

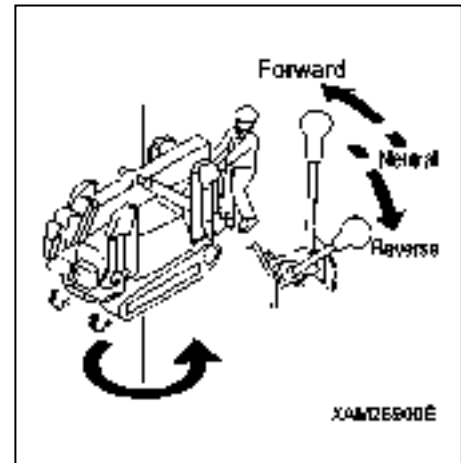

[3] CHANGING DIRECTION WHILE MOVING FORWARD/BACKWARD

• LEFT TURN WHILE MOVING FORWARD

While tilting the right travelling lever forward, return only the left travelling lever to the NEUTRAL position.

• LEFT TURN WHILE MOVING BACKWARD

While tilting the right travelling lever toward you, return only the left travelling lever to the NEUTRAL position.

• RIGHT TURN WHILE MOVING FORWARD

While tilting the left travelling lever forward, return only the right travelling lever to the NEUTRAL position.

• RIGHT TURN WHILE MOVING BACKWARD

While tilting the left travelling lever toward you, return only the right travelling lever to the NEUTRAL position.

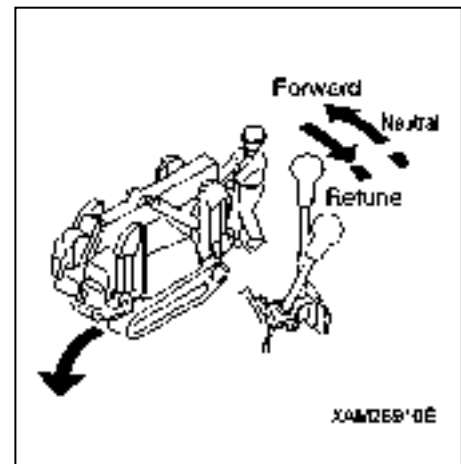

2.9 STOPPING/PARKING THE MACHINE

⚠ WARNING

- Avoid sudden stops and try to stop with a safety margin whenever possible.
- Choose a leveled and solid location for parking the machine.
If you park on the slope by necessity, provide some blocks so that the machine will not move.
- Careless contact with the travelling lever(s) during the engine operation may result in sudden movement of the machine, leading to serious accidents.
- Stop the engine and always remove the key for the starter switch. Take the key with you when you leave the machine.

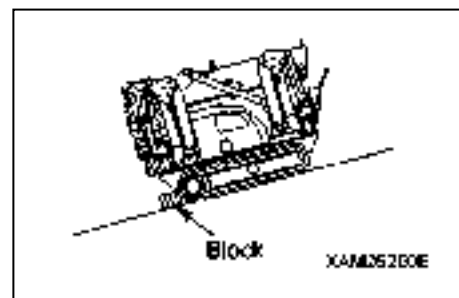

Operate the left and right travelling levers to the NEUTRAL position at the same time.

This automatically brakes the machine and the machine stops.

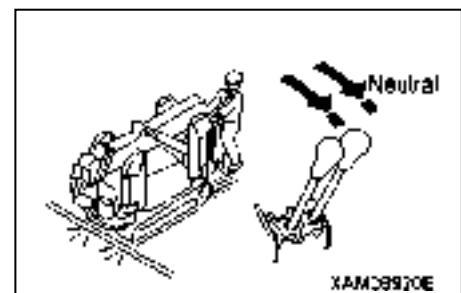

2.10 STOPPING THE ENGINE

CAUTION

- Stopping the engine before it sufficiently cools down may shorten the life of engine units. Do not stop the engine suddenly except for emergency.
- When the engine is overheated, do not stop the engine suddenly. Change the engine speed to low speed, and gradually cool down the engine before stopping the engine.
- Verify that the main switch at the remote controller control box unit is at the OFF position.

1. Pull the acceleration lever toward you fully and change the engine speed to low idling. Continue the no-load operation for about 5 minutes.

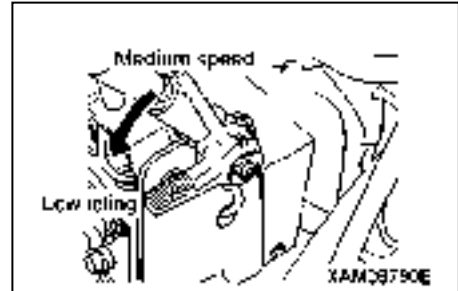

2. Turn the main starter switch key to the OFF position.
The engine stops.

3. Remove the main starter switch key.

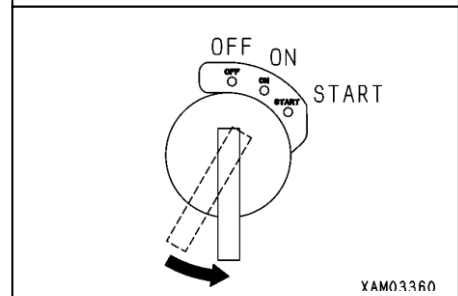

2.11 INSPECTION AFTER STOPPING THE ENGINE

1. Visibly check for oil leakage, fuel leakage, and water leakage, and check around the crawlers, crane, and exterior of the machine. If you find any leakage or abnormality, fix the problem.
2. Top of the fuel tank.
3. Dead leaves and papers around the engine will cause fire. Remove the dead leaves and papers.
4. Clean off mud on the crawlers and outriggers.

2.12 CAUTIONS WHILE DRIVING

WARNING

Not observing these cautions while driving will result in serious accidents.

[1] CAUTIONS WHILE DRIVING

- When travelling, stow hook and outrigger, and make sure the surrounding area is safe.
- When stowing outriggers, insert each of the position pins completely into lock.
- Driving over obstacles not only causes the overturning of the machine, but also gives an impact to the machine (especially around crawlers), causing breakage.

Avoid or remove the obstacles so as not to travel over them whenever possible.

If you have to travel over obstacles by necessity, be sure to take the “Travelling position” to lower the centre of gravity, and reduce the travelling speed as much as possible so that the machine will go over the obstacles at the centre of the crawlers.

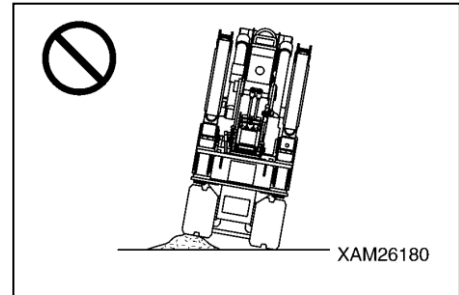

NOTES

See “Operation 2.5 Machine Travelling Position” for the travelling position of the machine.

[2] ALLOWABLE WATER DEPTH

If using this machine in water make sure of the depth of water under the centre of the idler (1) so that the muffler beneath the machine body doesn't go under water.

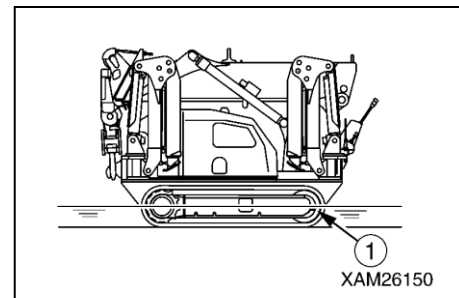

[3] CAUTIONS ON UPWARD/DOWNWARD SLOPE

⚠ WARNING

- If the machine tilts for “15 degrees” or more forward, backward, left, or right while travelling, the inclination alarm buzzer sounds. When sounding the alarm buzzer, do not travel on the slope of more inclination. The machine may overturn.
- Be sure to switch the travelling high-speed switch to the OFF (low speed) position when driving on the slope. Driving on the slope in the high-speed travelling mode may result in overrun on the downward slope.

- The slopes inclined for 15 degrees or more presents overturning hazard. Do not travel on these slopes.
- Be sure to switch the travelling high-speed switch to the OFF (low speed) position when driving on the slope. The machine may overrun.
- Never change the direction on the slope or cross the slope horizontally.
Travel safely such as by going down to the level ground and taking a detour.
- Operate the acceleration lever and travelling levers to decrease the travelling speed as much as possible when going down the slope.
Operating the travelling lever to the NEUTRAL position automatically brakes the machine, but may overrun when going down the slope at high speed.
- Direct the machine perpendicular to the slope and the operation position must be uphill side when driving on the slope.
- If the engine stops on the slope, return the travelling levers to the NEUTRAL position and start the engine.

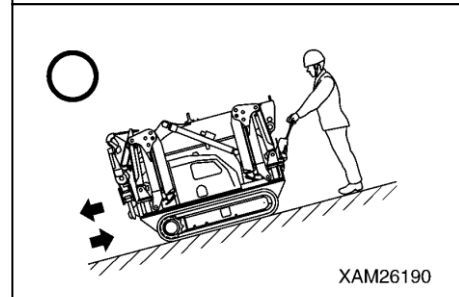
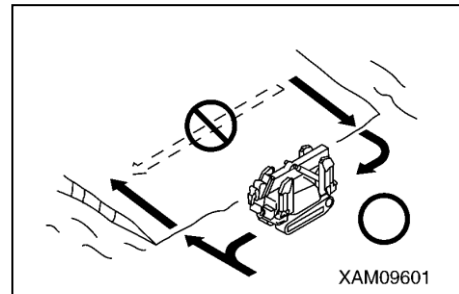

2.13 OUTRIGGER SET UP OPERATION

WARNING

• GROUND FOR SETTING OUTRIGGERS

Always set the outriggers on level, safe and solid ground.

Performing the crane operation without setting the outriggers can contribute to the overturning of the machine.

• EXTENDING AND SETTING THE OUTRIGGERS

- Keep people away from the machine when setting the outriggers.

Staying around the machine may cause serious accidents such as getting caught between an outrigger and the machine main unit.

- Always monitor the level gauge to level the machine when setting the outriggers.

When the machine tilts to "3 degrees" or more, the overturning alarm buzzer sounds.

- Set the outriggers so that the rubber tracks are about 2 inches (50 mm) above the ground.

After setting the outriggers, verify that all the four outriggers are securely set.

- The outriggers of this machine can be set flexibly according to the terrain. However, if the outriggers cannot be set in the "outrigger extended to maximum" state, perform the crane operation with the values given in the "Total rated load chart with outrigger extended to other than maximum" in the total rated load chart.

- When setting the outriggers, always maintain the outrigger rotary at the extension position, and insert the position pin to the end. Do not set the outriggers with the outrigger rotary stowed.

- When setting the outriggers, always extend the outrigger top.

Avoid setting outriggers when the outrigger top is stowed.

- During outrigger switching operation, always keep the engine in middle speed or lower speed.

When the engine is controlled to high speed, outriggers move too quickly which may result in serious accidents including tipping.

- Avoid controlling outriggers collectively on the ground other than flat and leveled. Otherwise, 4 outriggers do not touch the ground consistently which makes the machine inclined and may result in tipping.

- To lift up the machine by control of the Outrigger collective setting switch, use the procedure as follows:

- Never lift the machine up in a continuous rapid operation. That may result in the machine tipping. Turn the switch to OUT position and NEUTRAL position alternately so that you can ensure that 4 of outriggers extend equally.

- In such event that all the 4 outriggers are not extended evenly, use the applicable Outrigger individual setting switch to control the outrigger to be kept even.

- To lift up the machine by control of the Outrigger individual setting switches, use the procedure as follows:

- This machine has 4 outriggers. Be careful not to confuse the use of respective 4 Outrigger individual setting switch. Check both the outrigger numbers indicated in the control panel and number labels attached to each outrigger. A serious accident may be resulted when the outrigger numbers are confused.

- When you control 2 of the individual switches at one time, only 2 in the front (outriggers [(1)] and [(4)]) or only 2 in the rear (outriggers [(2)] and [(3)]) shall be operated at the same time. When 2 outriggers in either left or right side are controlled at the same time, these may extend very quickly to cause crane tipping.

- Use each of 4 Outrigger individual setting switches properly so that 4 outriggers extend evenly. Otherwise, when 2 outriggers in either left or right side extend very quickly, that may cause the machine to overturn.

- Any outrigger operations other than extending and retracting (e.g. inserting and extracting position pins) must be performed whilst engine is stopped. When any other persons touch any of the outrigger setting switches, that will cause a sudden motion of outrigger cylinders and may result in a serious accident.

CAUTION

For outrigger operations, set the travelling lever stand in the Travelling Operation Unit to the "Crane Operation Position". When the travelling lever stand is in "Travelling" position, any outrigger setting switches are not available for outrigger operations.

⚠ WARNING

• SELECTING LOCATION TO SET OUTRIGGERS

- When setting the outriggers on the structural objects such as construction site or concrete floor, verify in advance that the surface where the outriggers will be set has sufficient strength.

Insufficient strength in the setting surface will result in overturning or fall of machine due to collapse of the setting surface.

- Setting the outriggers on the soft ground as given below will cause the tray of the outriggers to sink in the ground, leading to the overturning of the machine.

- Road surface with low-cost pavement (low-cost asphalt or thin concrete)

- Surface with paving stones.

- Area reclaimed after excavation work

- Landfill

- Road shoulders or area close to a hole such as excavation work

- Deteriorated pavement surface

- Areas where under the pavement surface is hollow due to water erosion and the top soil appears to be hard but soft in the ground.

- Slope

• PROTECTING GROUND

- Place a sole plate of sufficient size with sufficient strength under the tray of all the outriggers on the soft ground to protect the ground.

- If you have to set the outriggers near the road shoulder by necessity, take secure action to prevent the collapse of the road shoulder.

- When working on the slope, level the tray of all the outriggers and the ground under the rubber tracks before setting the outriggers.

Setting the outriggers with the tilted ground surface without leveling the ground surface will cause the outriggers to slip or overturn, causing serious accidents.

- If the ground is not protected or if the outriggers may sink even after protecting the ground, do not perform the crane operations.



<p>Use of stable sole plate</p> <p style="text-align: right;">XAM21110</p>	<p>Surface with low-cost pavement</p> <p style="text-align: right;">XAM21120</p>	<p>Surface with paving stones</p> <p style="text-align: right;">XAM21130</p>
<p>Landfill, etc.</p> <p style="text-align: right;">XAM21140</p>	<p>Leveling ground of slope</p> <p style="text-align: right;">XAM26930</p>	<p>Leveling ground of slope</p> <p style="text-align: right;">XAM27460</p>

2.13.1 NAME OF OUTRIGGER COMPONENTS

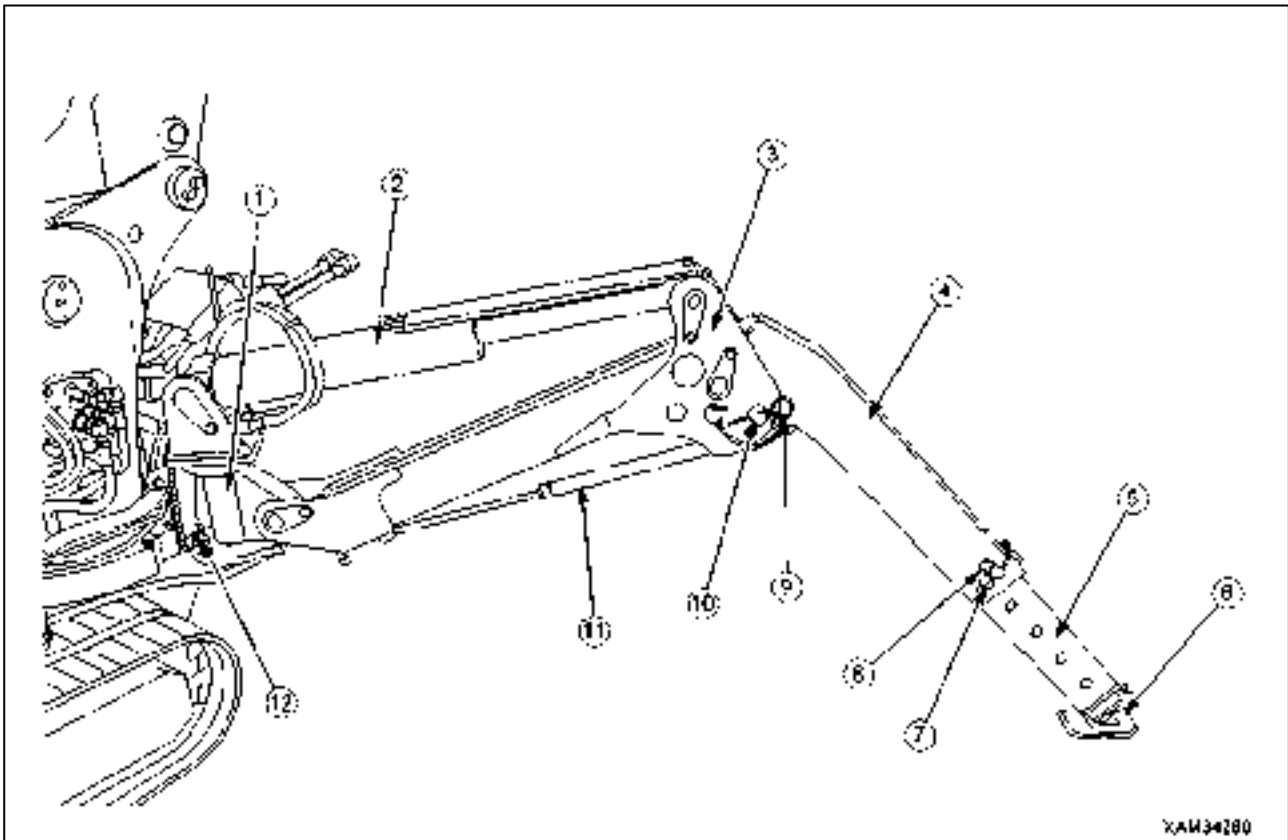

- | | |
|------------------------------|---------------------------------|
| (1) Outrigger rotary | (7) Inner box position pin |
| (2) Outrigger cylinder | (8) Snap pin |
| (3) Outrigger base | (9) Snap pin |
| (4) Outrigger top | (10) Outrigger top position pin |
| (5) Inner box | (11) Stay (Damper type) |
| (6) Outrigger adapter (Tray) | (12) Rotary position pin |

2.13.2 OUTRIGGER SET UP OPERATION

[1] TASKS TO BE PERFORMED UPON ENGINE STOP

⚠ WARNING

To install in "Outriggers MAX Extention" position, locations of holes for position pins (12) in outrigger rotaries (1) are different between outriggers [(1)] and [(4)] and (outriggers [(2)] and [(3)]).

Please read description in this section thoroughly so that you can install outriggers securely. This section describes the practice to install outriggers in "Outriggers MAX Extension" position.

There are four outriggers installed on the machine.

Installation of outriggers is achieved in the same way except for the setting positions of outrigger rotaries (1).

The setting positions of outrigger rotaries (1) are different between outriggers [(1)] and [(4)] and outriggers [(2)] and [(3)].

Read the descriptions in the following pages so that outriggers are correctly installed.

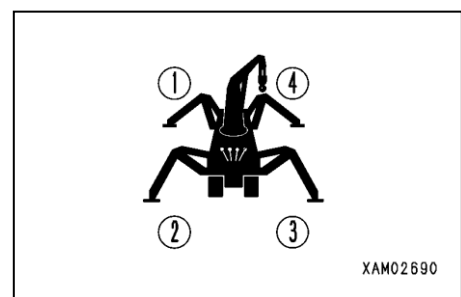

XAM02690

★Applicable to “outrigger (1) and (4)”

1. Pull the position pin (12) out of the outrigger rotary (1) and rotate the outrigger rotary outward.

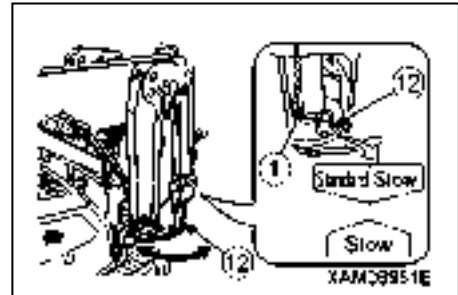

2. Rotate the outrigger rotary (1) so that the sticker "Standard/Stow" affixed to its side and the sticker "Standard" affixed to the side of frame are aligned.

3. Insert positioning pin (12) to the aligned hole of the outrigger rotary (1).

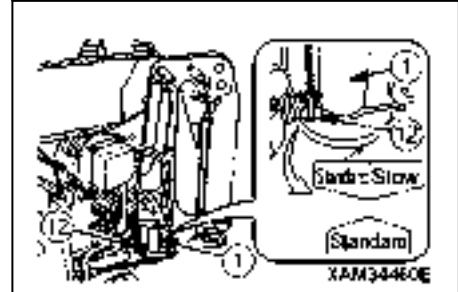

★Applicable to “outrigger (2) and (3)”

4. Pull the position pin (12) out of the outrigger rotary (1) and rotate the outrigger rotary outward.

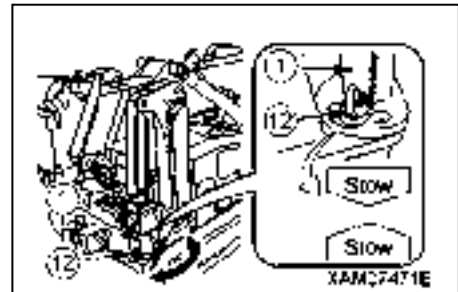

5. Rotate the outrigger rotary (1) so that the sticker "Standard" affixed to its side and the sticker "Standard" affixed to the side of frame are aligned.

6. Insert positioning pin (12) to the aligned hole of the outrigger rotary (1).

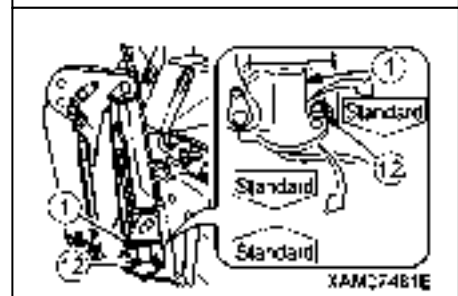

CAUTION

- Each position pin (12) contains a chain which prevents the pin from going missing. Make sure that such chains are not entangled with the frame. If so, it may result that position pins (12) are not inserted completely to the end of the hole in the outrigger rotary (1). Due to such an instable condition, that pin is likely to come out from the hole easily.
- Stickers in outrigger rotaries and frames should match as follows when outriggers are extended to the standard position: "Standard/Stow" and "Standard" for outriggers [(1)] and [(4)], while "Standard" and "Standard" for outriggers [(2)] and [(3)].

7. Pull out the snap pin (9) from the position pin (10) of the outrigger base (3) to pull out the position pin (10).

8. Lift up the outrigger top (4) to align the hole in the outrigger top (4) and the hole of the top position in the outrigger base (3) (as indicated by the sticker, "Extend to max.").

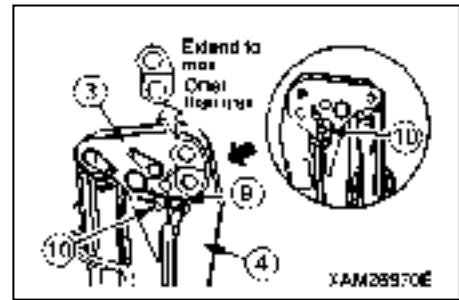

NOTES
Location of the hole of the top position in the outrigger base (3) is identifiable by the sticker, "Extend to max."

9. Insert the position pin (10) to hole of the top position in the outrigger base (3) (as indicated by the sticker, "Extend to max.") and secure it with a snap pin (9) at the end.

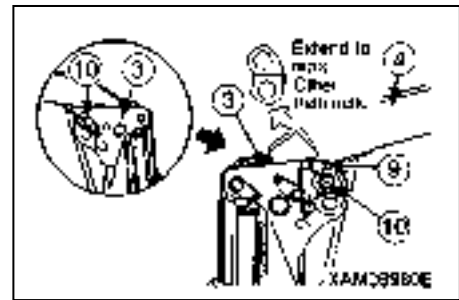

NOTES
When the position pin is inserted into any hole in the outrigger base (3) to which a sticker, "Other than max." is affixed, the crane operation shall be limited in accordance with the "Rated Total Load Chart with outrigger extended to other than maximum".

10. Pull the snap pin (8) out from the position pin (7) of the outrigger top (4) to pull out the position pin (7).

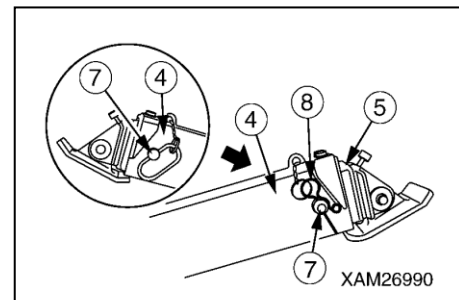

11. Pull out the outrigger inner box (5) from the outrigger top (4) and align the hole in the outrigger top (4) and the hole in the root position of the outrigger inner box (5).

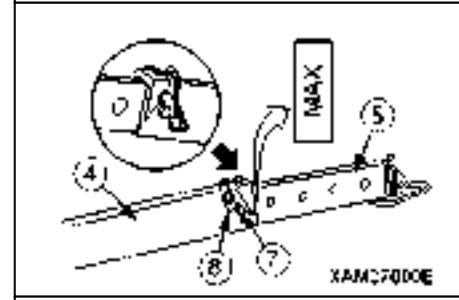

NOTES
The hole in the root position of the outrigger inner box (5) is a hole which matches the hole in the outrigger top (4) when a "MAX" sticker which is affixed to the side of the inner box is completely exposed.

12. Insert the position pin (7) to the hole of the outrigger top (4) then secure it with the snap pin (8).

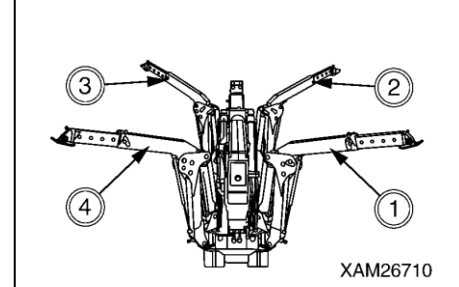

NOTES
When the pin is inserted into any hole other than the "MAX" of the inner box, the crane operation shall be limited in accordance with the "Rated Total Load Chart with outrigger extended to other than maximum".

13. When all the preparations as above complete, check again that each position pin and such is correctly inserted and secured by a snap pin or such.

[2] TASKS TO BE PERFORMED AFTER STARTING THE ENGINE

⚠ WARNING

- The overturning alarm buzzer sounds if the machine tilts for “3 degrees” or more when setting the outriggers. Operate the outrigger switches and adjust the machine to be leveled until the alarm buzzer stops.
- Avoid using the Outrigger collective setting switch where the installation height of each outrigger is different. Its use may cause the machine to incline or fall over.

CAUTION

Once 4 outriggers touch the ground consistently, use the Outrigger collective setting switch to facilitate smooth elevation of the machine.

1. See “Operation 2.2 Starting the Engine” to start the engine.
2. Pull up the lock lever (6) before pressing the whole lever stand (7) down to the "Crane Operation Position", then release the lock lever (6).
3. Move forward to the Crane Operation Unit.
4. Turn the acceleration lever to left or right side and change the engine speed to medium speed less than.
5. Open the outrigger switch cover and turn the Outrigger collective setting switch (16) to the OUT position. 4 outrigger cylinders start extending. Just before 4 Outrigger adapters (Trays) touch the surface of the ground, release the Outrigger collective setting switch (16) to the NEUTRAL position, once.

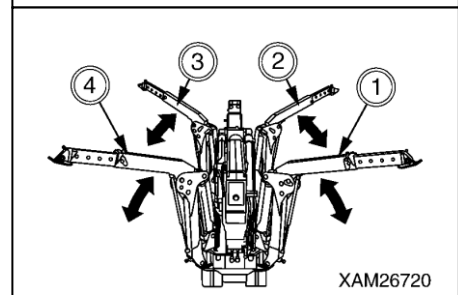
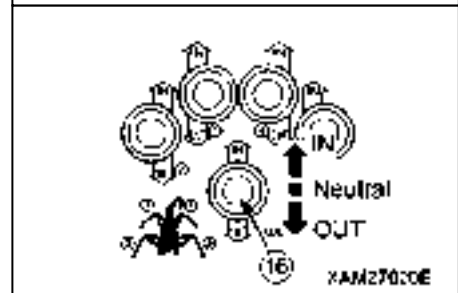
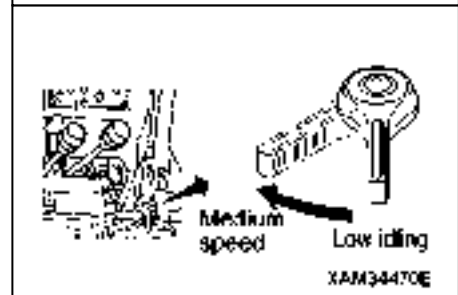
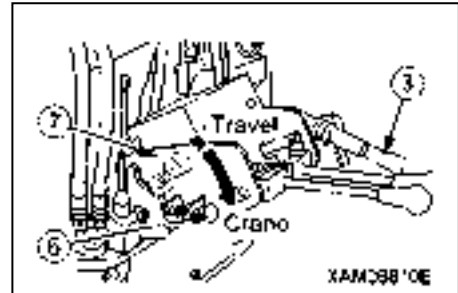

⚠ WARNING

When operating two individual outrigger operation switches at the same time, choose two front switches (outrigger (2) and (3)) or two rear switches (outrigger (1) and (4)). Operating two left or right switches at the same time will suddenly raise two outriggers on one side, causing the machine to overturn.

6. Check the number of the outrigger which has not yet touched the ground and assure the number in the control panel, to determine the outrigger number to operate.

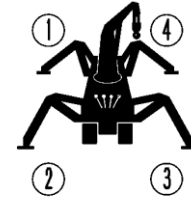

XAM02690

7. Open the outrigger switch cover and turn the Outrigger individual setting switch (15) respectively or 2 switches at the same time to the OUT position, so that all the 4 Outrigger adapters (Trays) touch the surface of the ground consistently.

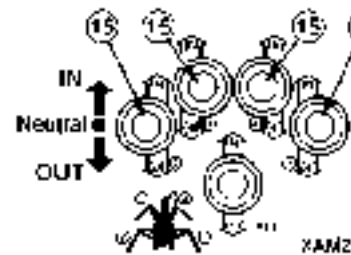

XAM27030E

8. After all the 4 Outrigger adapters (Trays) touch the surface of the ground consistently, turn the Outrigger collective setting switch (16) to the OUT position.

4 outrigger cylinders start extending. When the crane body is lifted up as high as approximately 50mm, release the Outrigger collective setting switch (16) to the NEUTRAL position.

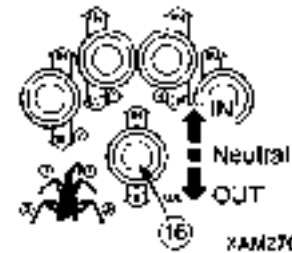

XAM27030E

9. When the machine was raised to about 50 mm above the ground, operate the outrigger individual operation switches while checking the position of the bubble in the level to adjust the machine to be leveled.

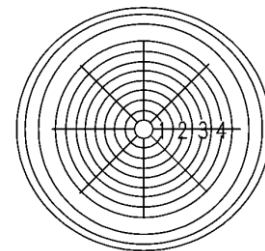

XAM00140

10. After setting the outriggers, operate all the outrigger operation switches to the NEUTRAL position.

11. When the outrigger installation as above completes, check again that all the position pins are correctly inserted and secured to prevent them from slipping out.

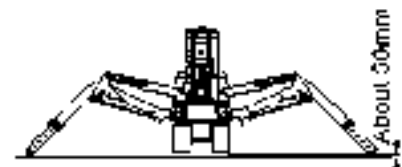

XAM28100E

2.14 CAUTIONS BEFORE CRANE OPERATION

⚠ WARNING

- Not observing these cautions before operation may result in serious accidents.
- It takes a certain moment for the over hoist detector to effect automatic interruption after it detects an over hoisting condition. Therefore, when the Over hoist and moment limiter alarm buzzer beeps, always release all of the operation levers to the NEUTRAL position. Otherwise, when operations as below are continued, such operation may not stop.
- Winch lever "UP" operation, Boom telescoping lever "Extending" operation and Boom derricking lever "Raise" operation.

- Verify that the emergency stop cancel switch, boom stowing switch, and hook stowing switch are at the OFF position. If these switches are at ON position, the operations will not stop.

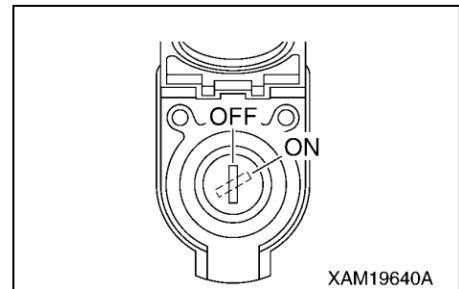

- Over hoisting the hook block will activate the alarm buzzer of the over hoist detector and the operation stops. When the alarm buzzer sounds, release your hand immediately from the winch lever (3) to the NEUTRAL position to stop raising the hook. Then, operate the winch lever (3) to "DOWN" (push forward) side to lower the hook block.

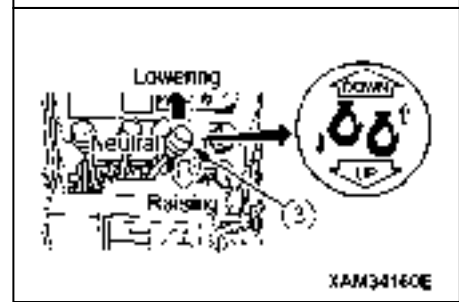

- Extending the boom will hoist the hook block, activating the alarm buzzer of the over hoist detector and the operation stops. When the alarm buzzer sounds, release your hand immediately from the boom telescoping lever (2) to the NEUTRAL position to stop extending the boom. Then, operate the boom telescoping lever (2) to "RETRACT" (pull toward you) side to retract the boom.

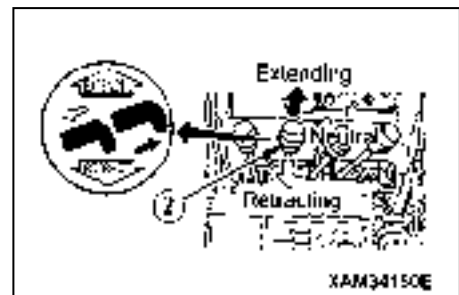

- Raising the boom will hoist the hook block, activating the alarm buzzer of the over hoist detector and the operation stops. When the alarm buzzer sounds, release your hand immediately from the boom derricking lever (4) to the NEUTRAL position to stop raising the boom. Then, operate the boom derricking lever (4) to "DOWN" (push forward) side to lower the boom.

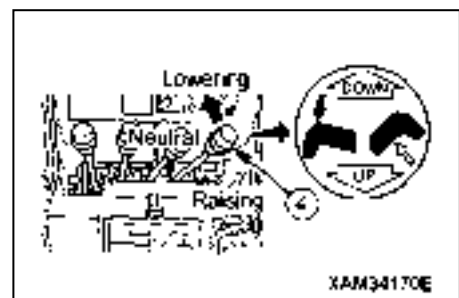

- Use the horn switch to honk the horn to notify the people around of the danger during the crane operation.
- Verify that all the outriggers are extended and set.

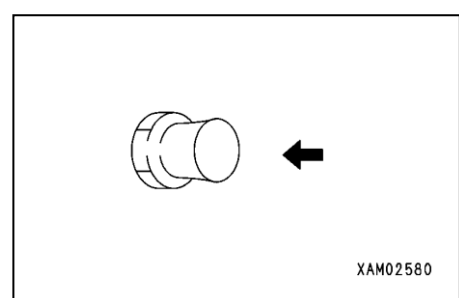

2.15 OPERATIONS BEFORE CRANE OPERATIONS

CAUTION

- For manipulation of each cranes operation levers and outrigger setting switches, set the travelling lever stand in the Travelling Operation Unit to the "Crane Operation Position". When the travelling lever stand is in "Travelling" position, each lever or outrigger setting switch is not available for its operation.
- When the hook block is released from its holder, be careful not to loosen the wire rope too much to let the hook lie on the ground. Such a condition may result in an irregular winding of the wire rope to the winch.

Perform the following operations before crane operation.

1. Pull up the lock lever (6) before pressing the whole lever stand (7) down to the "Crane Operation Position", then release the lock lever (6).
2. Move forward to the Crane Operation Unit.
3. Push the winch lever (3) forward to the "Lowering" position to slacken the wire rope which fixes the hook block.

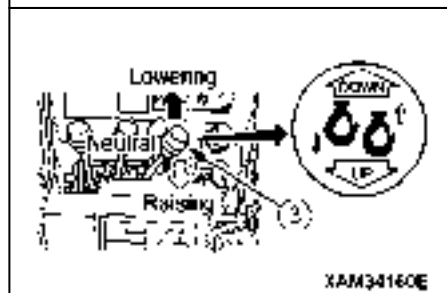
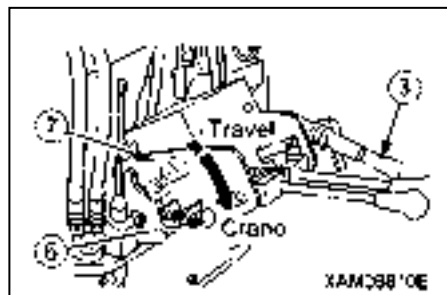

4. Remove the hook block (10) from the hook holder (9).

NOTES

Be careful to avoid the hook stopper (13) hitting the hook holder (9). That may damage the hook stopper (13).

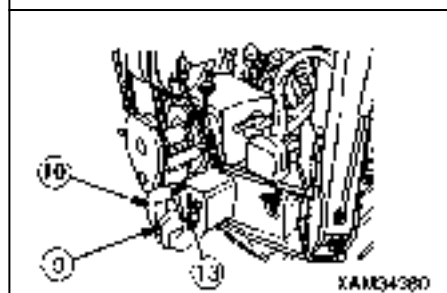

5. Push the winch lever (3) forward to the "Lowering" position until the hook block is lowered and the lever (12) of the over hoist detector (11) is released to "Lower" position.

NOTES

During this operation, pay attention not to unwind excessively to prevent the hook block from touching the ground surface.

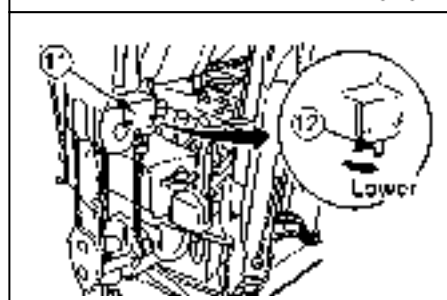

2.16 CRANE OPERATION POSITION

Take the crane operation position by following the procedure below when switching to the operation from the state described in "Operation 2.15 Operations before Crane Operations" in the Operation.

1. Turn the winch lever (3) to the "Lowering" position until the hook block is lowered and the lever (12) of the over hoist detector (11) is released to "Lower" position.

NOTES

During this operation, pay attention not to unwind excessively to prevent the hook block from touching the ground surface.

2. Hold the hook block with one hand and move the boom derricking lever to the "Raise" position (pull toward you) with another, so that the boom is slightly raised to the extent that the hook block does not cause over hoisting alarm.

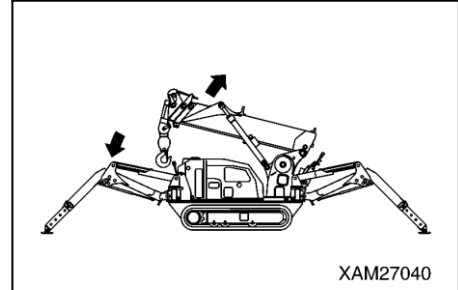
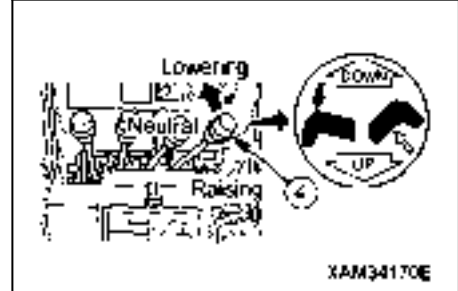
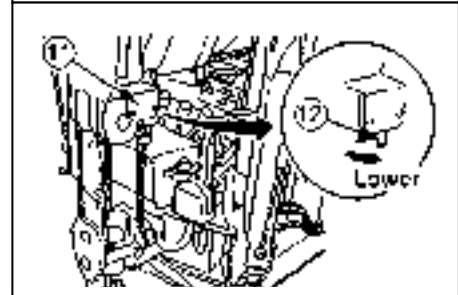
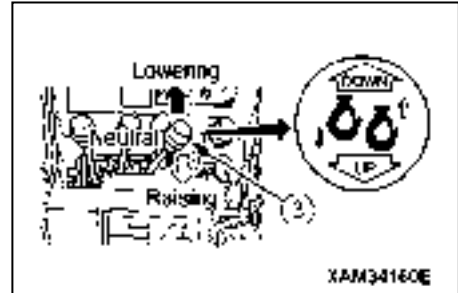

2.17 HOOK RAISING/LOWERING OPERATION

⚠ WARNING

- With the boom deflection, the hoisted load slightly shifts forward. Notify the workers around such as slinging operators.
- When hoisting a load, always stop hoisting once, when the load is raised above the ground. When such a practice is not exercised and the load is hoisted too quickly, that may cause a hazardous condition including breakage of the machine or tipping of it.
- When the hook block is over-wound, such condition is detected as an over hoist and operations including winching up, boom telescoping or boom raising are interrupted, as well as the Over hoist and moment limiter alarm buzzer beeps. When the buzzer beeps, immediately release control levers such as winch lever, boom telescoping lever or boom derricking lever to the NEUTRAL position so that all the crane operations are discontinued.
- When lowering the hook for long distance for underground works, be sure to leave more than three turns of the wire rope on the winch drum.

CAUTION

Do not let the hook block touch the ground.
The winch drum will wind irregularly, damaging the wire rope.

Operate the winch lever (3) as follows;

- Lower: Push the lever forward to the "DOWN" side.
- Neutral: Release your hand from the lever.

The lever will return to the NEUTRAL position and the raising/lowering of the hook block stops.

- Raise: Pull the lever toward you to the "UP" side.

NOTES

Adjust the winch raising/lowering speed with the winch lever and stroke of the acceleration lever.

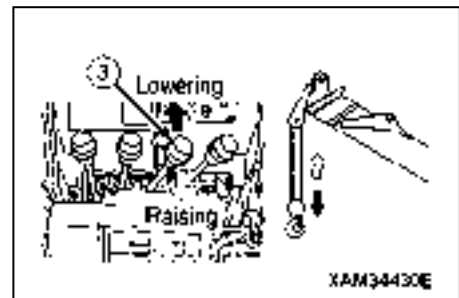

2.18 BOOM DERRICKING OPERATION

⚠ WARNING

- Operate the boom derricking lever as slowly as possible. Sudden lever operation especially while hoisting a load will cause the load to swing, giving a great impact to the machine, and thus may break the crane or overturn the machine.
- Lowering the boom increases the working radius and the rated total load that can be hoisted decreases. Be extremely careful so that the load weight will not exceed an overload as the boom is lowered when working by derricking the boom.
- When the hook block is over-wound, such a condition is detected as an over hoist and operations including winching up, boom telescoping or boom raising are interrupted, also the Over hoist and moment limiter alarm buzzer beeps. When the buzzer beeps, immediately release control levers such as winch lever, boom telescoping lever or boom derricking lever to the NEUTRAL position so that all the crane operations are discontinued.

Operate the boom derricking lever (4) as follows.

- Lower: Push the lever forward to the “LOWER” side.
The lever goes back to the NEUTRAL position and the boom derricking stops.
- Neutral: Release your hand from the lever.
- Raise: Pull the lever toward you to the “RAISE” side.

NOTES

Adjust the boom derricking speed with the boom derricking lever and the stroke of the acceleration lever.

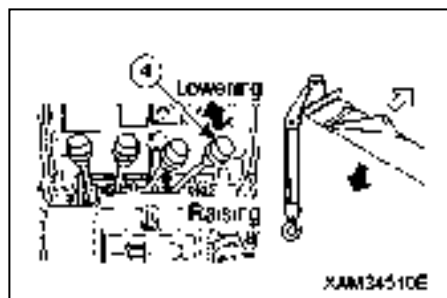

2.19 BOOM TELESCOPING OPERATION

⚠ WARNING

- Operate the boom telescoping lever as slowly as possible. Sudden lever operation especially while hoisting a load will cause the load to swing, giving a great impact to the machine, and thus may break the crane or overturn the machine.
- Do not pull the load horizontally or pull in the load by telescoping the boom.
- Extending the boom increases the working radius and the rated total load that can be hoisted decreases. Be extremely careful so that the load weight will not exceed an overload with the boom most extended when working by telescoping the boom.
- When the hook block is over-wound, such a condition is detected as an over hoist and operations including winching up, boom telescoping or boom raising are interrupted, also the Over hoist and moment limiter alarm buzzer beeps. When the buzzer beeps, immediately release control levers such as winch lever, boom telescoping lever or boom derricking lever to the NEUTRAL position so that all the crane operations are discontinued.

CAUTION

- The hook block is raised or lowered while telescoping the boom. Perform the winch operation at the same time to adjust the hook block height.
- When the boom is maintained extended for a long time, the boom slightly retracts due to the temperature change in the hydraulic oil. In this case, extend the boom as needed.

Perform the boom telescoping lever (2) as follows.

- Extend: Push the lever forward to the "EXTEND" side.
- Neutral: Release your hand from the lever.

The lever returns to the NEUTRAL position and the boom telescoping stops.

- Retract: Pull the lever toward you to the "RETRACT" side.

NOTES

Adjust the boom telescoping speed with the boom telescoping lever and the stroke of the acceleration lever.

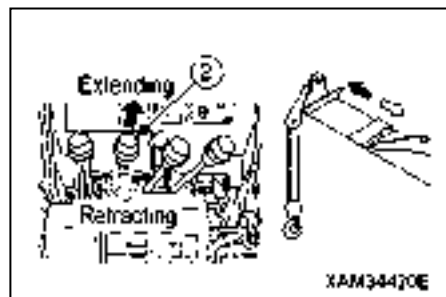

2.20 SLEWING OPERATION

⚠ WARNING

- Check the safety around and honk the horn before slewing.
- Operate the slewing lever as slowly as possible.
Start smoothly, slew at low speed, and stop gently.
Sudden lever operation especially while hoisting a load will cause the load to swing, causing the loss of stability in the machine, and thus may break the crane or overturn the machine.
- Where it is necessary to slew the crane 360-degree with a hoisted load, all the outriggers must be extended to its basic direction as shown in the diagram on the right. Even though outriggers are fully extended as shown, operations to the left or right require extra caution as there is less stability.
- In cases where the outriggers installation is restricted and full extension as shown in the diagram on the right is not possible, ensure the operable and inoperable areas are known in advance, before starting crane operations.
- Depending on how outriggers are extended, the hoisted load may hit an outrigger during the slewing operation, breaking the crane or overturning the machine. Be careful not to let the hoisted load hit an outrigger.

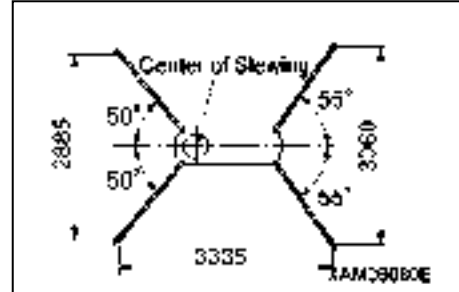

Operate the slewing lever (1) as follows.

- Slew counter clockwise: Push the lever forward to the “LEFT” side.
- Neutral: Release your hand from the lever.
The lever returns to the NEUTRAL position and the slewing stops.
- Slew clockwise: Pull the lever toward you to the “RIGHT” side.

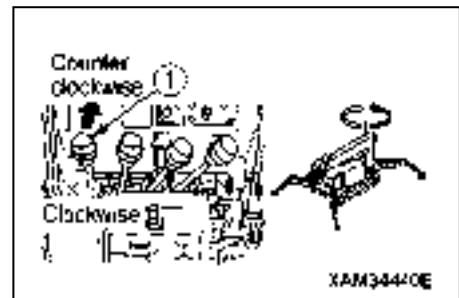

NOTES

Adjust the crane slewing speed with the slewing lever and the stroke of the acceleration lever.

2.21 ACCELERATION OPERATION

⚠ WARNING

Accelerating the operation speed of the crane functions more than is necessary is dangerous.

CAUTION

Decrease the speed in the beginning or near the end of an operation. Change the speed to low speed or high speed according to the load.

Operate the acceleration lever (6) as follows.

- Low idling: Fully turn the lever toward right.
The engine speed decreases and the operation speed of the crane functions slows down.
- High speed: Fully turn the lever toward left.
The engine speed increases, and the operation speed of the crane functions accelerate.

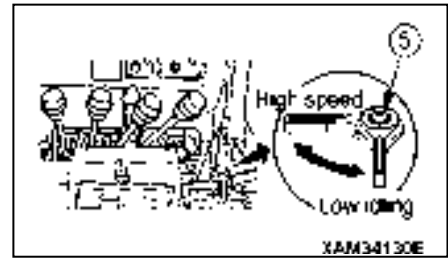

NOTES

At the desired engine speed for your work, release the lever. It will stop at that position.

2.22 CRANE STOWING OPERATION

⚠ CAUTION

- The hook stowing switch cancels the auto stop function of the over hoist detector. Operate the winch lever carefully not to let the hook block hit the boom when stowing the hook block.
- Use this hook stowing switch only for the purpose to stow the hook.
- When fastening the hook block to its holder, be careful so that your hands are not trapped.
- When the hook block is stowed in the hook block holder and the wire rope slacking is eliminated, turn OFF the hook stowing switch without delay. Otherwise, the wire rope will be over-wound which causes it to wedge into the winch drum.

CAUTION

- Stop the swing of the hook block before stowing the hook block.
- When stowing the hook block, do not topple the entire hook block sideways on the ground by loosening the wire rope too much. This will cause irregular winding on the winch drum.
- The boom “retracting” operation will lower the hook block. The hook block also lowers with the boom “lowering” operation. Raise the hook at the same time so that the hook block will not touch the ground or interfere with the machine.
- When fastening the hook block, be careful not to give excessive tension to the wire rope. That may damage the wire rope or the hook holder to fasten the hook block. On the other hand, when the wire rope is loose, the hook block may swing which cause it to hit components around and damage them.
- When fastening the hook block, use hook stowing switch to wind up the wire rope. Since this switch enables slower winding than the normal operation by winch lever, it facilitates inching.

1. Operate the boom telescoping lever (2) to the “RETRACT” (pull toward you) side to fully retract the boom.

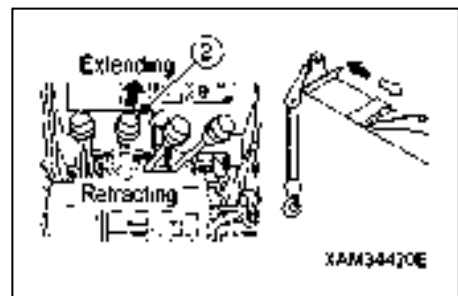

2. Operate the slewing lever (1) to the “LEFT” or “RIGHT” side so that the boom slews to the centre of the machine.

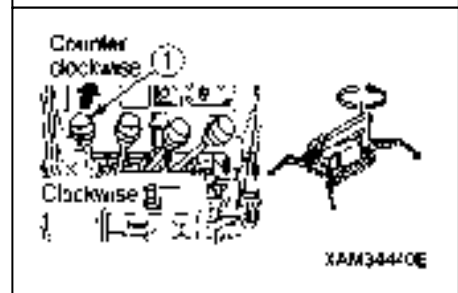

3. Operate the boom derricking lever (4) to the “LOWER” (push forward) side and lower the boom until it automatically stops.

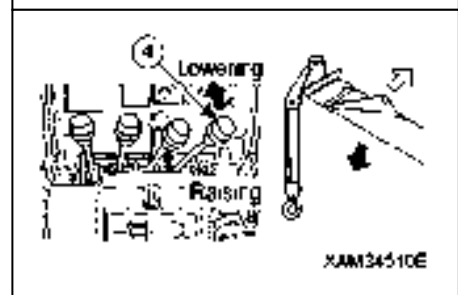

4. With the boom stowing switch placed to the ON position, operate the boom derricking lever (4) again to the "LOWER" (push forward) side to stow the boom.

NOTES

The boom shall be fully lowered in this operation. During this operation take care not be trapped by the hook block.

5. Operate the winch lever (3) to the "UP" (pull toward you) side and winch until the hook block automatically stops (over hoist).

NOTES

Hoisting the hook block too much will result in the detection of over hoist. Then the alarm buzzer will be heard and the hook raising operation automatically stops.

6. Hold the hook block with one hand and turn the hook stowing switch to the ON position (Upward) to wind up the hook block (10).

7. Leave the hook stowing switch in the ON position (Upward) and fasten the hook of the hook block (10) to the hook holder (9).

NOTES

To put in the hook to the holder (9), keep the hook stopper (13) of the hook block (10) closed and move the hook laterally to the holder (9).

Otherwise, if the hook stopper (13) of the hook block (10) is opened and set the hook to the the holder (9) by moving the hook upward, the hook stopper (13) may be damaged.

8. Leave the hook stowing switch in the ON position (Upward) yet and wind up the hook block (10) to eliminate the wire rope slack.

9. When the hook block (10) is secured, release the hook stowing switch soon so that it returns to OFF position (Downward) and winding up stop.

10. After the hook block (10) is stowed, shake the hook block (10) to ensure that it would not hit anything around. Where any interference is seen, repeat procedures 6 and 7.

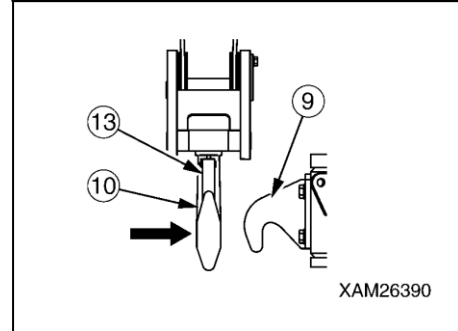
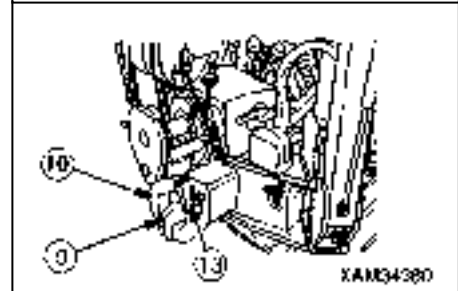
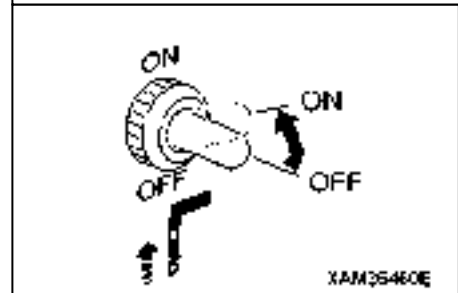
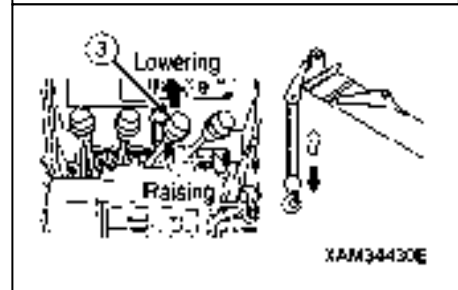
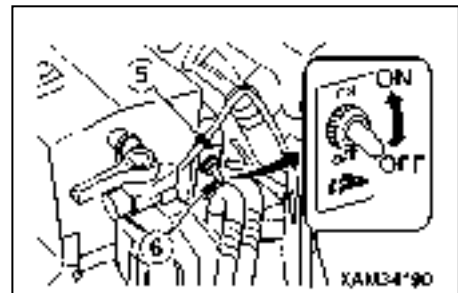

2.23 OUTRIGGER STOWING OPERATION

⚠ WARNING

- Do not let people approach the machine when stowing the outriggers. Staying around the machine may result in serious accidents such as getting caught between an outrigger and the main unit of the machine.
- Verify that there is nothing under the rubber tracks when stowing the outriggers. If there is any object under the rubber tracks, the machine may overturn and serious accidents may occur when stowing the outriggers.
- Stop the engine for operation except for extending/setting the outrigger cylinders. Another person touching an outrigger may result in sudden movement of the outrigger cylinder, which may lead to serious accidents.
- When the position pin is removed, the outrigger inner box and outrigger top loses the support and rotates. Always hold the outrigger inner box and outrigger top with one hand when removing the position pin.
- Do not put your hands or fingers around the gaps of movable areas when stowing the outriggers. Your hands or fingers may get caught, and it may lead to serious accidents.
- Insert the position pin to the end and secure with snap pin when stowing the outriggers.
- Reduce the engine speed to medium speed less than when operating the outrigger switches. At the high engine speed, the outriggers operate suddenly, leading to serious accidents such as overturning of the machine.
- To put down the lifted machine by control of the Outrigger collective setting switch, use the procedure as follows:
 - Avoid lowering the machine in a continuous rapid operation, when the machine is installed on a slope or rough terrain. The machine may tip during such an operation. Turn the switch to IN position and NEUTRAL position alternately so that you can ensure that 4 of outriggers retract equally to lower the machine to the ground.
 - In such event that all the 4 outriggers are not retracted evenly, use the applicable Outrigger individual setting switch to control the outrigger to be kept even.
- To lower down the raised machine by control of the Outrigger individual setting switches, use the procedure as follows:
 - This machine has 4 outriggers. Be careful not to confuse the use of respective 4 Outrigger individual setting switch. Check both the outrigger numbers indicated in the control panel and number labels attached to each outrigger. A serious accident may be resulted when the outrigger numbers are confused.
 - When you control 2 of the individual switches at one time, only 2 in the front (outriggers [(1)] and [(4)]) or only 2 in the rear (outriggers [(2)] and [(3)]) shall be operated at the same time. When 2 outriggers in either left or right side are controlled at the same time, these may retract very quickly to cause crane tipping.

CAUTION

For outrigger operations, set the travelling lever stand in the Travelling Operation Unit to the "Crane Operation Position".

When the travelling lever stand is in "Travelling" position, any outrigger setting switches are not available for outrigger operations.

There are four outriggers installed to the machine.

Stowing of outriggers is achieved in the same practice except for the setting positions of outrigger rotaries (1).

The stowing positions of outrigger rotaries (1) are different between outriggers [(1)] and [(4)] and outriggers [(2)] and [(3)].

Read descriptions in next pages so that outriggers are correctly stowed.

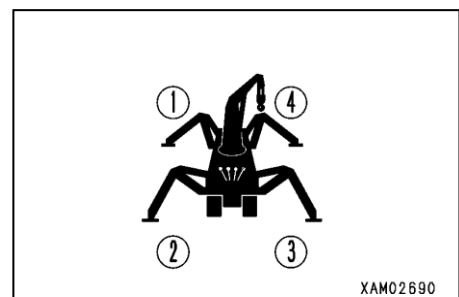

[1] TASKS TO BE PERFORMED AFTER STARTING THE ENGINE

⚠ WARNING

- Avoid using the Outrigger collective setting switch in a condition where installation height of each outrigger is different. Its use may make the machine significantly inclined or overturn.
- When stowing outriggers, be careful to avoid your body or clothes being trapped between outriggers and the machine body.

CAUTION

When 4 outriggers are installed equally at the same height, use the Outrigger collective setting switch. It facilitates smooth elevation of the machine.

1. See "Operation 2.2 Starting the Engine" and start the engine.
2. Turn the acceleration lever to right to change the engine speed to below medium speed.

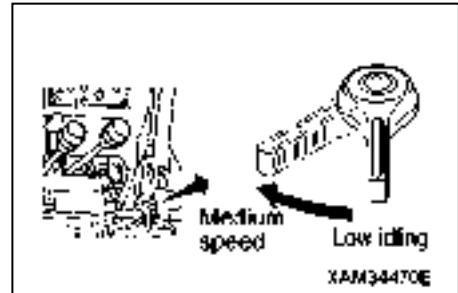

- ★When 4 outriggers are installed equally in the same height, operate the outrigger collective setting switch as below:

CAUTION

On level ground, use the Outrigger collective setting switch to retract 4 outriggers all at once. It facilitates smooth lowering of the machine to the ground.

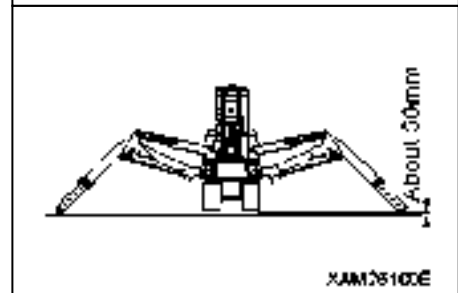

3. Open the outrigger switch cover and turn the Outrigger collective setting switch (16) upward to the IN position. Outrigger cylinders start retracting and the machine is lowered. Continue this operation until the rubber tracks stand firmly on the ground.

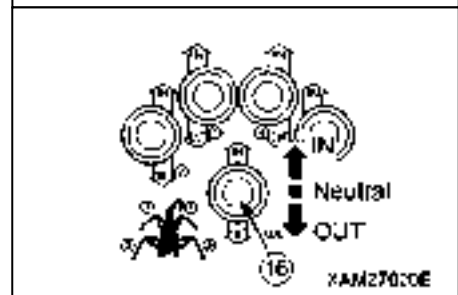

★When 4 outriggers are installed unevenly in the different heights, operate the outrigger individual setting switch as below:

⚠ WARNING

When you control 2 of the individual switches at one time, only 2 in front (outriggers [(1)] and [(4)]) or only 2 in rear (outriggers [(2)] and [(3)]) shall be operated at the same time. When 2 outriggers in either left or right side are controlled at the same time, these may retract very quickly to cause crane tipping.

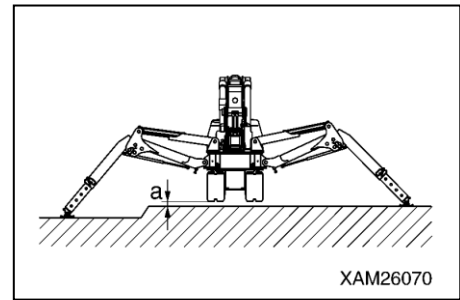

XAM26070

CAUTION

When 4 outriggers are installed unevenly in the different heights, use the outrigger individual setting switch to lower the machine slowly until the rubber tracks touch the ground.

4. Assure the number of the outrigger individual setting switch in the control panel, to determine the outrigger number to operate.

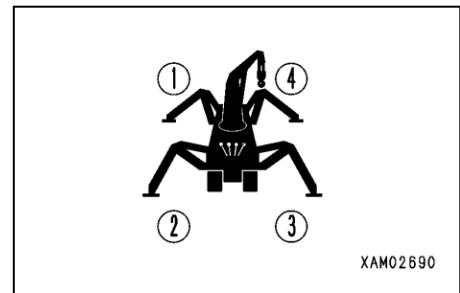

XAM02690

5. Open the outrigger switch cover and turn the Outrigger individual setting switch (15) respectively or 2 switches at the same time to the IN position.

When the outrigger cylinder starts retracting and machine starts to lower, release the switch to return to the NEUTRAL position, once.

Continue the same operation of the other individual setting switches (15) to retract all the 4 outriggers so that the all are kept in the same level, then return to the NEUTRAL position, once.

Repeat such operations until the rubber tracks stand firmly on the ground.

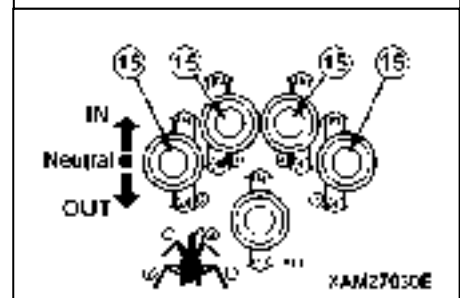

XAM27030E

6. When the both left and right rubber tracks are completely lowered to the ground, turn the Outrigger collective setting switch (16) upward to the IN position.

When Outrigger cylinders retract to raise outrigger top to the limit, release the Outrigger collective setting switch.

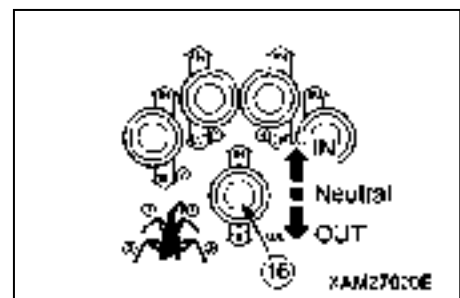

XAM27030E

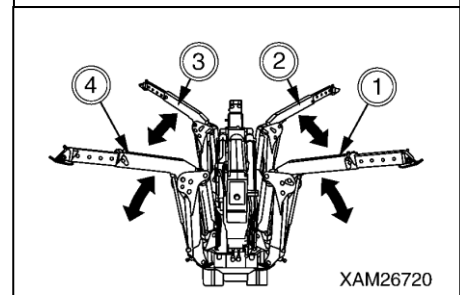

XAM26720

7. Push down the auxiliary starter switch to the STOP position.
The engine stops.

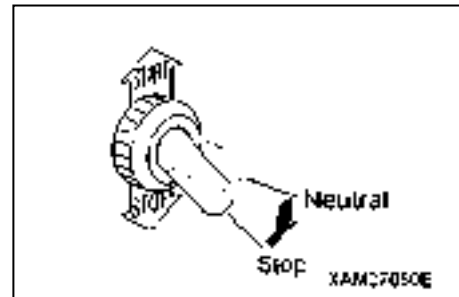

8. Turn the main starter switch key to the OFF position and remove the main starter switch key.

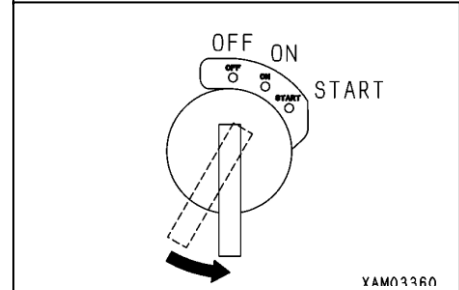

9. Pull up the lock lever (6) before pressing the whole lever stand (7) down to the "Travelling position", then release the lock lever (6).

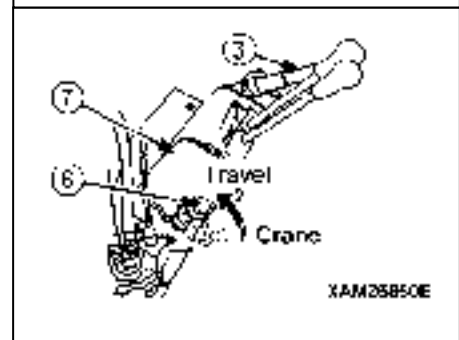

[2] TASKS TO BE PERFORMED UPON THE ENGINE STOP

1. Remove the snap pin (8) of the position pin (7) tip of the outrigger top (4) and pull out the position pin (7).

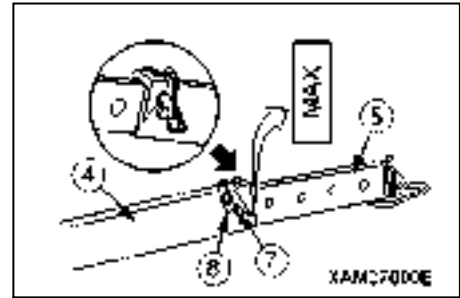

2. Push the inner box (5) into the outrigger top (4) and align the hole of the outrigger top (4) and the hole nearest to the end of the inner box (5).

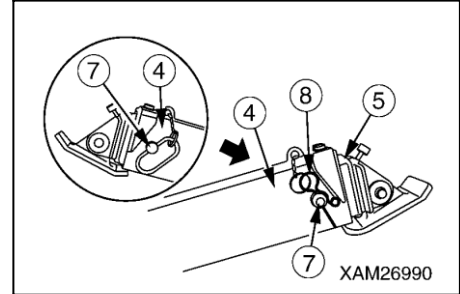

3. Insert the position pin (7) to the hole of the outrigger top (4) and secure with snap pin (8).

4. Remove the snap pin (9) of the position pin (10) tip of the outrigger base (3) and pull out the position pin (10).

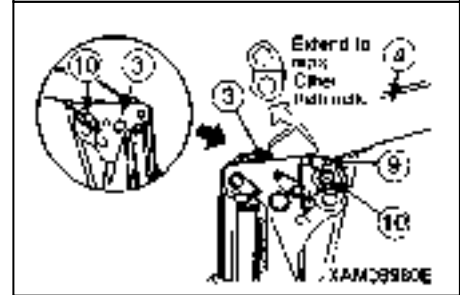

5. Lower the outrigger top (6) and align the hole of the outrigger top (6) and the hole of the lowest position in the outrigger base (3).

6. Insert the position pin (9) to hole of the lowest position in the outrigger base (3) and secure it with a snap pin (8) at the end.

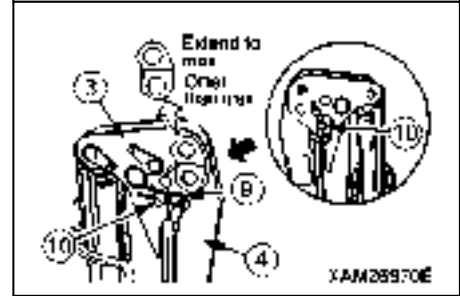

★Applicable to “Outrigger (1) and (4)”

7. Pull out the position pin (12) of the outrigger rotary (1) and rotate the outrigger rotary (1) inward.

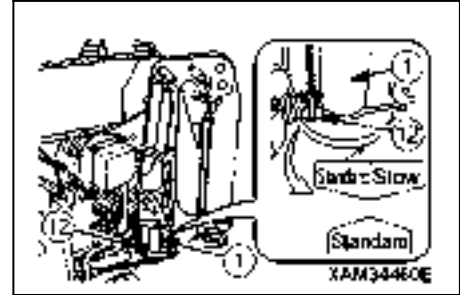

8. Rotate the outrigger rotary (1) so that the sticker "Standard/Stow" affixed to its side and the sticker "Stow" affixed to the side of frame are aligned.

9. Insert positioning pin (12) to the hole with the sticker "Standard/Stow" of the outrigger rotary (1).

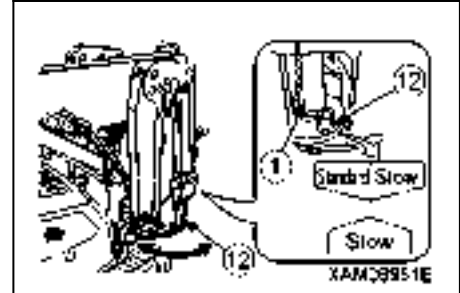

★Applicable to “Outrigger (2) and (3)”

10. Pull out the position pin (12) of the outrigger rotary (1) and rotate the outrigger rotary (1) inward.

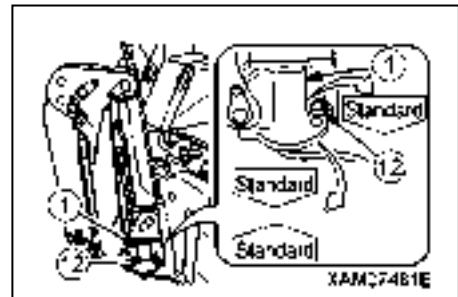

11. Rotate the outrigger rotary (1) so that the sticker "Standard" affixed to its side and the sticker "Stow" affixed to the side of frame are aligned.

12. Insert positioning pin (12) to the hole with the sticker "Stow" of the outrigger rotary (1).

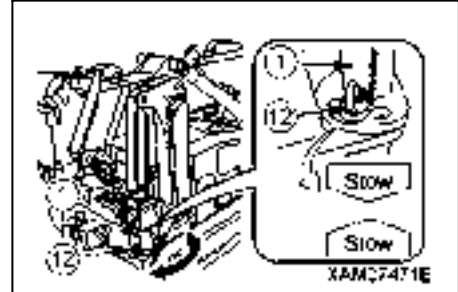

13. When the outrigger is stowed, check each position pin is correctly inserted and secured by a snap pin or such.

2.24 DO'S AND DON'TS DURING CRANE OPERATIONS

⚠ WARNING

- Always set the outriggers on level, solid ground when performing the crane operations.
- Never perform travelling hoist or the crane operations without setting the outriggers. The machine will be unstable and overturn, leading to serious accidents.
- See the cautions given in the Safety besides the do's and don'ts in this section.

[1] DON'T OPERATE WITH SLEWING FORCE

Drawing in or lifting the load with slewing operation is prohibited.

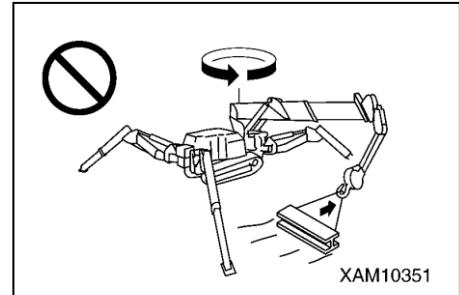

[2] DON'T OPERATE WITH DERRICKING FORCE

Drawing in or lifting the load with boom derricking operation is prohibited.

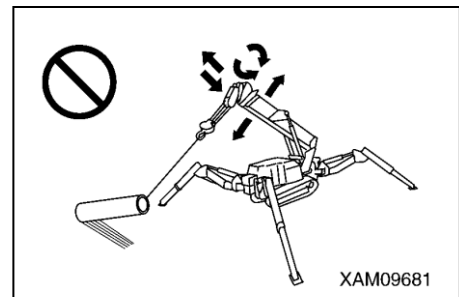

[3] DON'T PULL SIDWARD, DRAW IN OR HOIST DIAGONALLY

Pulling sideward, drawing in, or hoisting diagonally applies unreasonable force on the machine. It not only damages the machine body, but is also dangerous. Never operate in these ways. The hook must come right above the centre of gravity of the load hoisted.

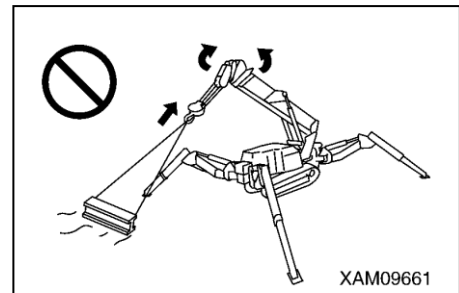

[4] DON'T OPERATE VIOLENTLY DURING OPERATION

Do not operate the lever suddenly.

Especially, the "slewing", "boom lowering", and "hook lowering" must be operated at low speed.

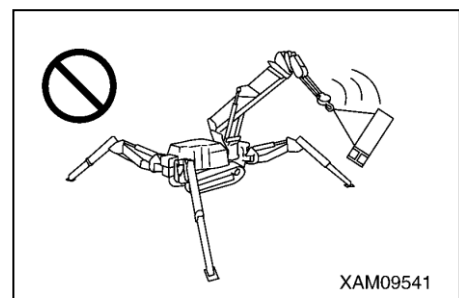

[5] DON'T ALLOW ACCESS INTO WORKING RADIUS

Do not let people into the working radius, such as permitting an operator to go under the hoisted load.

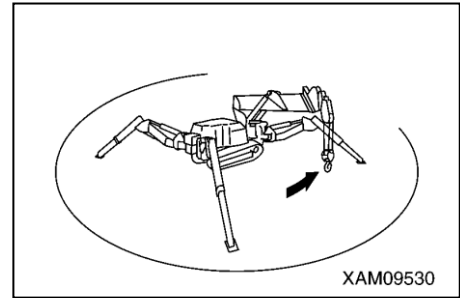

[6] DON'T USE FOR ANYTHING OTHER THAN MAIN APPLICATIONS

Do not move people up/down with the crane.

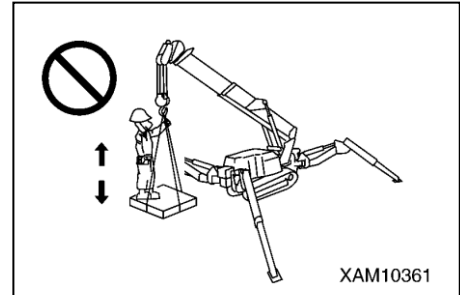

[7] DON'T PERFORM UNREASONABLE OPERATIONS

Operations requiring more than the machine performance can cause accidents.

Particularly, the crane operations must be carried out according to the total rated load chart.

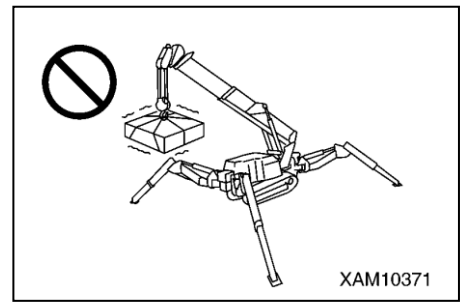

[8] DON'T WIND WIRE BY FORCE

Be careful not to hook the wire rope over a tree or steel beam while working.

If it gets stuck with something, do not force to wind the wire. Untangle and then wind the wire.

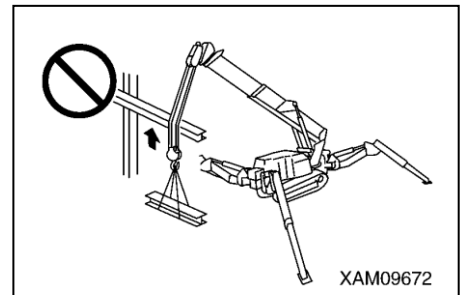

[9] DON'T ATTEMPT TRAVELLING A HOISTED LOAD

Traveling with hoisted load or operating crane without outriggers set may cause crane to tip.

Do not perform these operations.

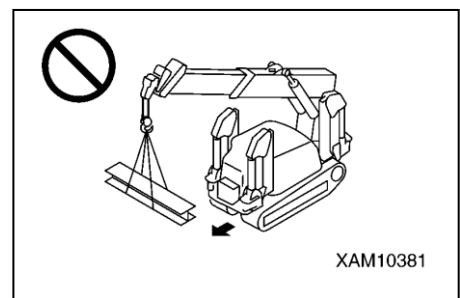

3. HANDLING RUBBER TRACKS

3.1 GOOD USE

While the rubber tracks demonstrate many advantages thanks to its performance characteristic to the material, it has a weak point in strength.

Therefore, we would like you to sufficiently understand the characteristics of the rubber tracks and to respect the do's and don'ts and observe the cautions on handling so that the life of the rubber tracks can be extended and its advantages exercised.

Be sure to read "3.3 Dos and Don'ts with Rubber Tracks" and "3.4 Cautions in Using Rubber Tracks" in the Operation before using the machine.

3.2 WARRANTY

Verification of proper tension of the rubber tracks, maintenance of rubber tracks, and damage caused by the fault of customers such as not respecting the do's and don'ts or not observing caution whilst working, for example, "worked at the site where there were objects that may tear the rubber blocks, such as steel plates, U-shaped gutters, corners of bricks, corners of sheer broken stones and rocks, reinforcing steels, and iron scraps", are not covered by warranty.

3.3 PROHIBITIONS AND CAUTIONS WHEN USING RUBBER TRACKS

WARNING

Not observing these cautions in using rubber tracks will cause serious accidents or damage to the rubber tracks.

Keep the followings in mind during the operation.

- Working and slewing on the ground with broken stones, hard rock ground with great irregularity, reinforcing steels, iron scraps, and near the edge of the steel plates will damage the rubber tracks.
- Working where there is a large amount of large and small boulder stones such as river beds, the stones will go under the machine, tending to damage the rubber tracks or the rubber tracks tend to come off.
- Keep oil and chemical solvents away from the rubber tracks. If these materials come in contact with the rubber tracks, wipe it off immediately. Do not TRAVEL over the road surface where oil has built up.
- Do not go in an area where it is hot, such as with open fire, the steel plate left under the burning sun, or newly poured asphalt.

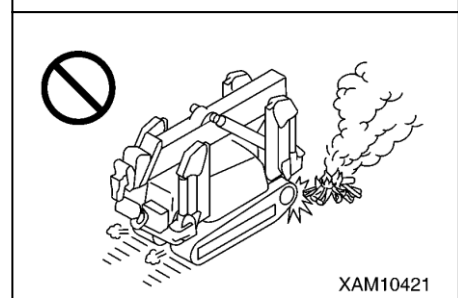
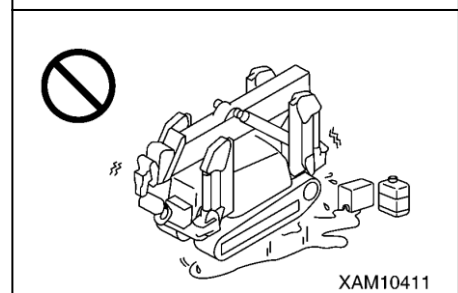
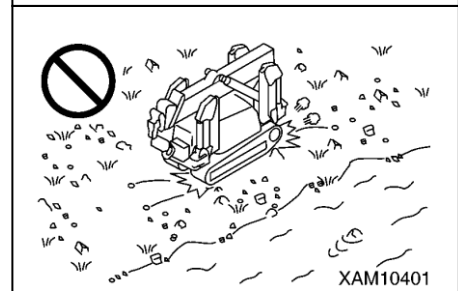
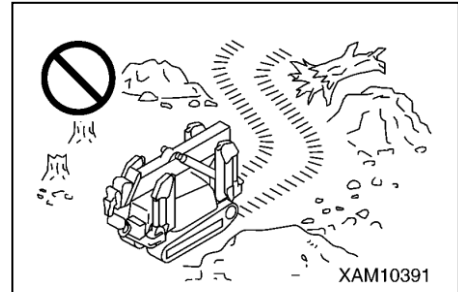

- Avoid making spin turns on the concrete surface.
Sudden steering cause's early wear or defects to the rubber tracks. Avoid making sudden steering whenever possible.

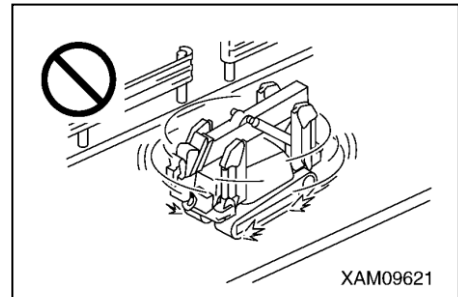

- Do not operate the machine in a way that the edge of the rubber tracks is pressed against concrete and walls.

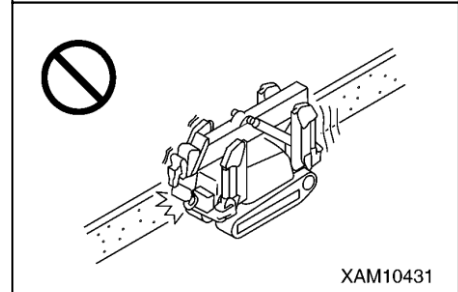

- Avoid steering at the location with a large step.
Ensure the machine is perpendicular to the step when going over it. Going over the step diagonally may result in the rubber tracks coming off.

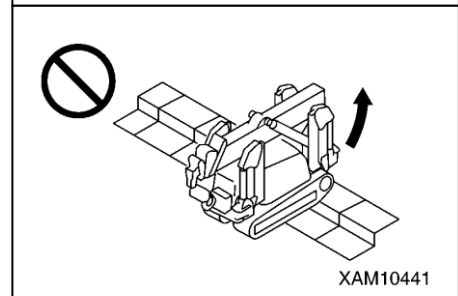

- Avoid using the rubber tracks whenever possible depending on the material to be worked on.
If you have to use the rubber tracks on these materials, wash thoroughly with water after use.
 - Avoid the operation on crushed material and yielding oil (such as soy beans, corns, rape cake, etc.)
 - Handling salt, ammonium sulfate, potassium chloride, or concentrated superphosphate corrodes the bonding at the cored bar section.

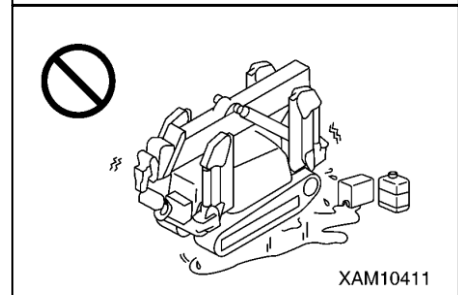

- Salt corrodes the bonding at the cored bar section. Avoid using the machine on the beach whenever possible.

- Operation in extreme cold changes the material of the rubber tracks, shortening its life.
Use the rubber tracks in the range of -25°C to + 55°C, due to the physical properties of the rubber.

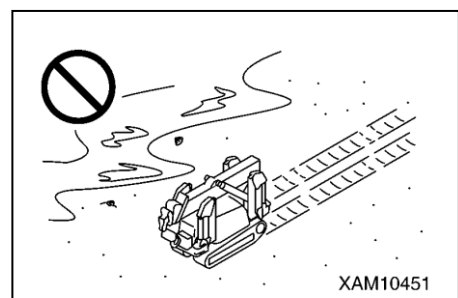

- When handling food such as salt, sugar, wheat, and soybeans, some pieces of wire or rubber may be mixed in the food if there is any deep scratch on the rubber tracks.

Use the rubber tracks after repairing the cracked rubber.

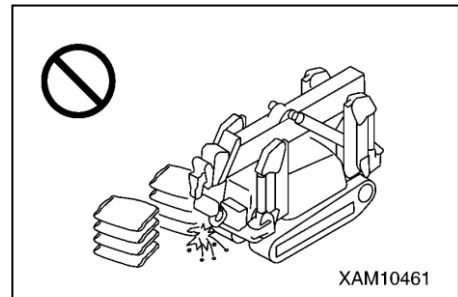

- The rubber tracks slip very easily on a wet steep plate or snowed and frozen surface. Be especially careful not to slip when operating on the slope.

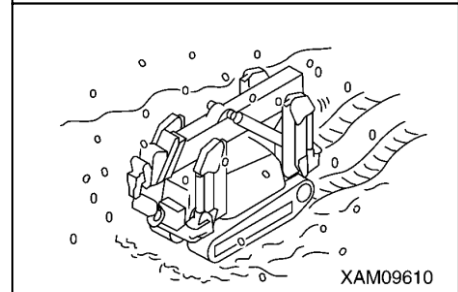

- Always use the rubber tracks at appropriate tension to prevent the rubber track from coming off.

Loose tension will allow the rubber tracks to come off.

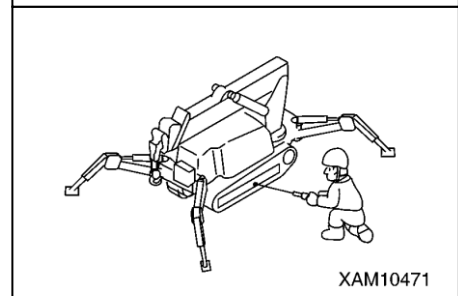

- Keep the rubber tracks indoors away from direct sunlight or rain when storing them for a long time (three months or more).

4. WHAT TO DO WITH TWISTED WINCH WIRE ROPE

⚠ WARNING

Be sure to wear a pair of thick leather working gloves when handling wire ropes.

CAUTION

Change the winding direction of the wire rope (reverse the hook block side and winch drum side) from time to time to extend the life of the wire rope.

When the wire rope becomes twisted, straighten the twist with the following procedure.

1. With the hook in normal condition, check the twisting direction and how many times the rope is twisted.
2. Operate the winch lever to "DOWN" (push forward) side to lower the hook block onto the ground.

If the hook cannot be lowered, operate the boom derricking lever to the "LOWER" (push forward) side to lower the boom or operate the boom telescoping lever to the "RETRACT" (pull toward you) side to retract the boom to lower the boom.

3. Push down the auxiliary starter switch to the STOP position to stop the engine.

4. Remove the wedge socket pin securing bolt (3) to remove the wedge socket (2).
5. Forcibly twist the end of the wire for "n" (number of wire falls) times the number that the hook has twisted, in the opposite direction from the direction the hook block is twisted to - which you checked in the step 1 (opposite direction that the wire rope tries to go back to naturally when you release your hand from the wedge socket) and install the wire rope.
6. Start the engine and operate the boom derricking lever to the "RAISE" (pull toward you) side to increase the boom angle to its maximum.
7. Operate the boom telescoping lever to the "EXTEND" (push forward) side to extend the boom to its maximum.
8. Operate the winch lever to repeat raising/lowering the hook block for several times.
9. Tidily spool up the wire rope into the winch drum with some tension applied to the rope.
10. Repeat the above procedure until the hook is longer twisted.

If the wire rope is still twisted after performing the procedure above, change with a new wire rope.

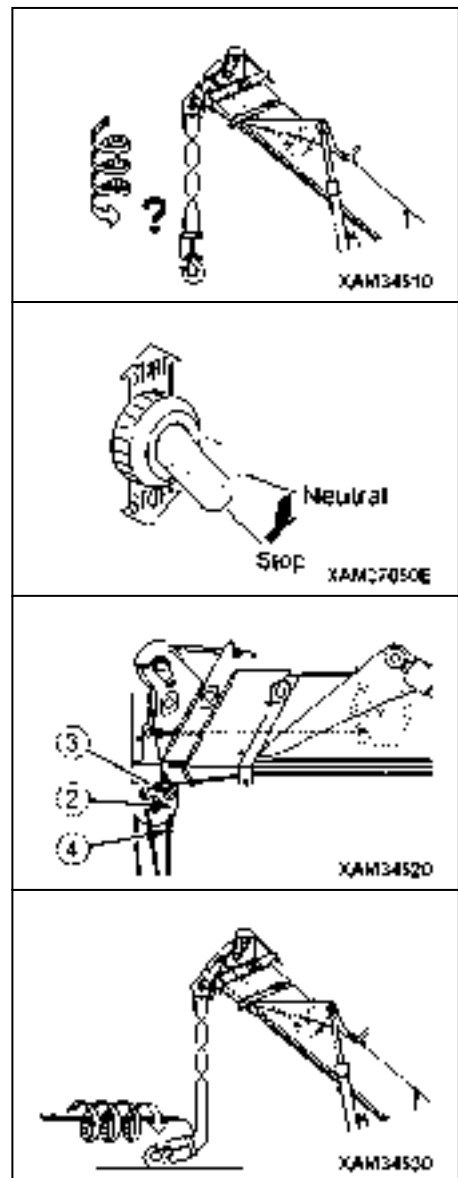

5. TRANSPORTATION

Observe the related laws and regulations and transport the machine safely.

5.1 LOADING/UNLOADING

WARNING

- See "Specifications 1.1 Specification List " in the Dimension for the dimensions and mass of the machine.
- Select and use the ramp boards that satisfy the following conditions.
 - Has the length that when placed, the angle from the track is 15 degrees or less.
 - Has the width no narrower than the rubber tracks.
 - Has the thickness and strength that can fully withstand the mass of the machine.
- Be sure to place the ramp boards perpendicular to the truck bed.
Also, match the centre of the each of the rubber tracks with the centre of corresponding ramp board. Misguided ramp boards and unmatched rubber crawlers may cause the machine to slip out of the ramp boards and cause serious accidents.
- Use ramp boards with slope of 15 degrees or less. The space between boards shall be set to be appropriate to the centre of the rubber tracks.
- Always put the machine in the "Travelling position" when loading/unloading the machine. See "Operation 2.5 Machine Travelling Position" for travelling position.
- Always load the machine by moving backward. Moving forward involves overturning hazard. The operator must be on the back side of the truck.
- Always unload the machine by moving forward. Moving backward risks overturning. The operator must be behind the machine.
- Loading/Unloading the machine involves danger. Be extremely careful.
- Select flat and solid ground for loading/unloading the machine. Keep sufficient distance from the shoulders.
- Remove dirt around the crawlers to prevent side slip of the machine on the ramp boards. Remove any materials on the loading ramps such as ice, grease, and oil.
- Never change direction on the ramp boards. Go down from the ramp board, and then change the direction.

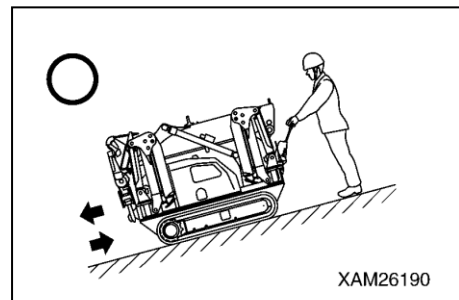

Always put the machine in the "Travelling position" when loading/unloading the machine. Always use ramp boards or forwarding blocks when loading/unloading the machine and use the following procedure.

1. Brake the trailer securely. Place wheel blocks to the wheels of the trailer to secure the trailer.
2. Secure the ramp boards in a way that the centre of the trailer and the machine agree.

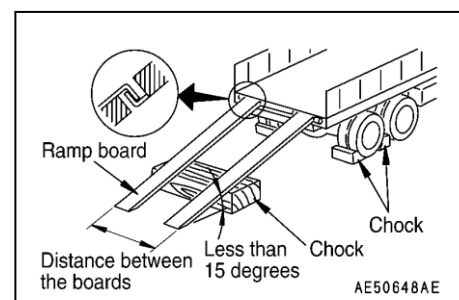

NOTES

Verify that the two ramp boards are at the same height.

3. Operate the acceleration lever and keep the engine at low speed.
4. TRAVEL slowly toward the ramp boards, and load/unload the machine in a way that the boom does not hit the trailer. Move backward to load the machine, and forward to unload the machine.
5. Do not operate any other lever than travelling levers on the ramp boards.
6. Load the machine properly to the desired position on the trailer.

5.2 HOISTING MACHINE

⚠ DANGER

- When lifting up the Machine, always set it to the stowage position first, and lift from the lifting bracket (A) on the top of the boom. Only use this bracket and only one sling wire. Any other manner than this, i.e. from other lifting brackets or multiple sling wires, may cause droppage of the machine and result serious injury or death.

Where there is no choice but the machine has to be hoisted in a different manner, please contact us or service agencies.

- The hoisting attachments such as wire rope and shackle used in hoisting shall be sufficiently strong for the weight of this machine.
- Crane stowed position when it is hoisted means its "Travelling position" where 4 of outrigger position pins are securely inserted in the outrigger rotary. The centre of the balance of the machine is specified subject to the machine being in its travelling position. In addition, to set it into that position correctly, secure the hook block (4) to its stowing position, also tension the wire rope tight, this will prevent the boom derricking cylinder form extending. Refer to "Operation 2.5 Machine Travelling Position" for details of travelling position.
- Hoisting the machine for a long time will cause the boom derricking cylinder to extend, shifting the centre of gravity and the machine to lose balance. Thus, hoisting should be limited to a max of 10 minutes.
- Where it is required to hoist the machine for a longer time (exceeding 10 minutes), or when it is carried by a helicopter, use a proper carriage deck as shown in the diagram on the right, for safe transportation.

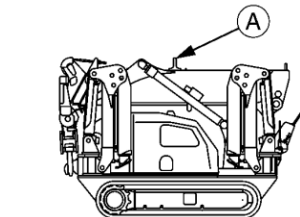

XAM27090



XAM03980

CAUTION

- When the local laws and regulations are applicable, the person who uses the crane to perform hoisting operation must be qualified to do it. If not, the operator must be well trained and skilled.
- See the Dimension or the nameplate attached to the machine for the weight of the machine.
- The dimensions are for standard specifications. The hoisting method varies depending on the attachments and options mounted. In that case, contact us or our sales service agency.

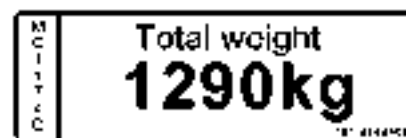

Hoist the machine on solid and flat ground using the following procedure.

1. See "Operation 2.5 Machine Travelling Position" and put the machine in the "Travelling position".
2. Verify that the position pins (four) are securely inserted in the outrigger rotary joint of the 4 outriggers.
3. Hang the hook (2) directly to the bracket (A) on the top of the boom, or use a shackle (1) to hang the hook (2).

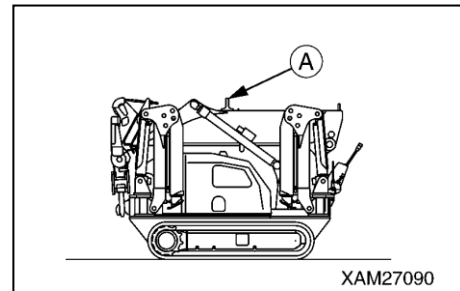

NOTES
Position (A) on the top of the boom is in the centre of gravity of the machine.

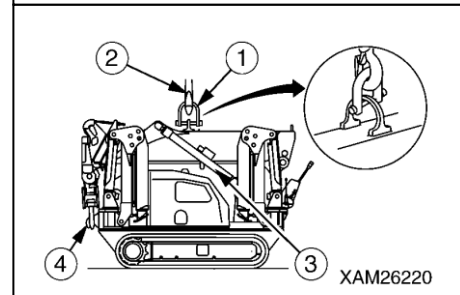

4. As soon as the machine leaves the ground, stop and wait until the machine is stabilized. Then slowly hoist the machine.
5. Check the changes in the position due to the leakage from the hydraulic circuit on the head side of the derricking cylinder (4) when the machine is hoisted.

5.3 CAUTIONS IN LOADING MACHINE

⚠ WARNING

Select flat and solid ground for loading/unloading the machine. Keep sufficient distance from the shoulders.

Load the machine to the specified position on the trailer and secure the machine with the following procedure.

1. Stop the engine and remove the key of the main starter switch.
2. Put rectangular lumbers at the front and rear of the rubber tracks to prevent the machine from moving, and stretch chains or wire ropes between the shackle of the machine body and trailer deck tightly, in addition.

Ensure it is well secured so it does not slip to the side.

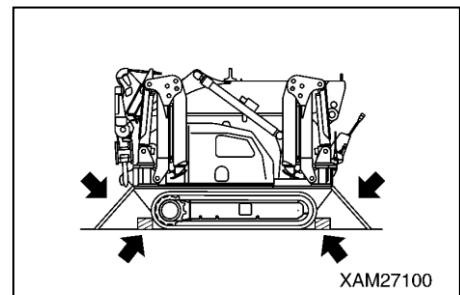

5.4 CAUTIONS DURING TRANSPORTATION

⚠ WARNING

Take road width, height, and weight into consideration when determining the transportation route.

If there are applicable local laws and regulations, observe these laws and regulations for safe transportation.

If not, contact us or our sales service agency.

6. HANDLING IN COLD WEATHER

6.1 PREPARING FOR LOW TEMPERATURE

When the temperature goes down, the machine may have some difficulty in starting. Take the following actions.

[1] LUBRICATION

Change the oil to the one with low viscosity. See "Maintenance 5.1 Use of Lubricating Oil According to Temperature" for the specified viscosity.

[2] BATTERY

WARNING

- The battery produces combustible gas and can be explosive. Do not put fire close to the battery.
- The battery fluid is a harmful substance. Keep it away from your eyes and skin. Should it come into contact with your eye or skin, wash the affected area with plenty of water and consult a physician immediately.

The battery capacity drops when the temperature goes down.

In this condition, the battery fluid can freeze with low battery charging rate. Keep the charging rate as close to as 100%. Keep the battery warm in order to start the engine next morning.

NOTES

Measure the specific gravity of the battery fluid and convert it into the charging rate using the chart below.

		Fluid Temperature (°C)			
		20	0	-10	-20
Charging Rate (%)	100	1.28	1.29	1.30	1.31
	90	1.26	1.27	1.28	1.29
	80	1.24	1.25	1.26	1.27
	75	1.23	1.24	1.25	1.26

[3] CAUTIONS AFTER COMPLETING THE OPERATION

Observe the following to prevent the machine from not being able to function the next morning because of deposits such as dirt, water and materials being frozen around the feet.

- Remove the dirt and water on the machine.

Keep the hydraulic cylinder rod surface especially clean to prevent seal from being damaged with the dirt coming into the seal together with the water drops.

- Park the machine on solid and dry ground.

If there is no such location to park, place a board on the ground to park the machine on the board.

This prevents the ground and around the feet of the machine from freezing and allows the machine to start moving next morning.

- Remove the drain plug to drain the water in the fuel system to prevent the water from freezing.
- The battery ability drops substantially at low temperature.

Cover the battery or remove the battery from the machine and keep it in a warm place to be installed next morning.

- If the electrolyte level is low, refill with distilled water next morning before starting the operation.
Do not refill after the operation in order to prevent the water from freezing during the night.

[4] AS THE WEATHER GETS WARMER

When the seasons change and it has started to get warmer, take the following action.

- See "Maintenance 5.1 Use of Lubricating Oil According to Temperature" to change the oil in the system to the one with specified viscosity.

7. LONG-TERM STORAGE

7.1 BEFORE STORING THE MACHINE

CAUTION

The machine shall take the position shown in the diagram on the right during the long-term storage to protect the cylinder rod. See "Operation 2.5 Machine Travelling Position" for travelling position. (To prevent rust on the cylinder rod)

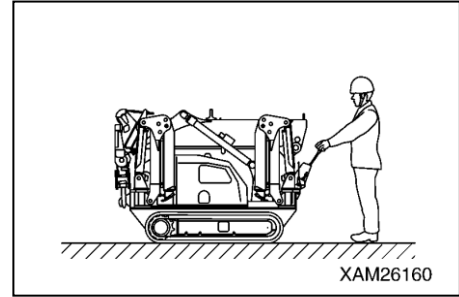

Store the machine as described below for long-term storage.

- Wash and clean each section of the machine and store indoor.
If you absolutely have to leave it outdoors, select a flat location where the machine is not likely to be exposed to flood or other disasters and cover the machine.
- Refuel, grease, and change the oil without fail.
- Disconnect the negative terminal of the battery and cover, or disconnect the battery from the machine for storage.
- Refer to "Inspection and Maintenance 8.6 Irregular Maintenance [4] Engine maintenance for Long-term Storage" and drain all the fuels in the tank and carburetor.

7.2 DURING STORAGE

⚠ WARNING

If you have to perform an antirust operation indoors, open the window and doors for better ventilation to prevent gas poisoning.

Be sure to operate the machine once a month during the storage to maintain the oil film at lubricating section. Charge the battery at the same time.

7.3 AFTER STORAGE

⚠ WARNING

If you did not perform antirust operation monthly during the long-term storage, contact us or our sales service agency before using the machine.

Perform the followings before using the machine after the long-term storage.

- Refuel, grease, and change the oil without fail.
- Remove the cover over the battery (install the battery to the machine if dismantled for storage).
Check the electrolyte level and specific gravity, and then connect the battery cable from the positive side.
- Remove the drain plug of the fuel tank, hydraulic oil tank, and engine oil pan to drain the water mixed in.
- Carefully perform the check before starting operation and warm-up operation.
Carefully check the various parts of the machine.

8. HANDLING THE BATTERY

Observe the followings when handling the battery.

⚠ WARNING

- Stop the engine and turn the main starter switch to the OFF position when checking/ handling the battery.
- Wipe off the dust accumulated on the top of the battery with a moistened cloth.
- The battery produces hydrogen gas, involving an explosion hazard. Do not put fire such as cigarettes close to the battery or take any actions that can cause sparks.
- The battery fluid is diluted sulfuric acid, which corrodes clothes and skin. Should the battery fluid come into contact with your clothes or skin, wash the affected area immediately with plenty of water. Should it go into your eye, wash your eye immediately with clean water and consult a physician.
- Wear goggles and rubber gloves when handling the battery.
- Disconnect the ground side (normally (-) terminal) first to remove the battery, and conversely, connect the (+) terminal first to install the battery. Objects such as tools coming between (+) terminal and the machine body will cause sparks.
- Slackened battery terminals can cause sparks with poor contact, involving explosion hazard. Tighten securely when installing the terminals.
- Secure the battery when changing the battery to prevent the battery from being displaced. If it is not secured, the terminals will slacken, causing sparks.
- Verify the (+) terminal and (-) terminal when removing and installing the battery.

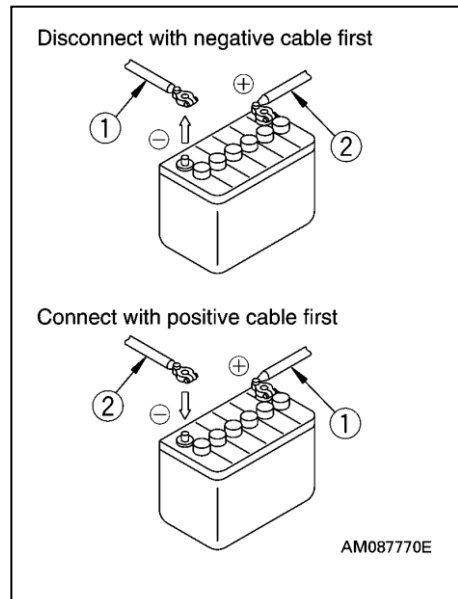

8.1 CAUTIONS IN HANDLING THE BATTERY

- Always try to keep the battery charged.
The battery should not be charged in a rush after being discharged. Measure the specific gravity of the battery fluid in advance and charge the battery as needed.
Keeping the battery in the best condition lengthens the life of the battery.
- Check the electrolyte level earlier than regular check and maintenance schedule during the hot season.
- The battery performance drops substantially during the cold season. Keep the charging rate as close to as 100% and try to keep it warm for starting the operation next morning.

8.2 REMOVING/INSTALLING THE BATTERY

CAUTION

Ensure that the battery does not move after securing the battery. If it moves, secure it again.

[1] REMOVAL

1. See "Operation 1.6 Machinery Cover" to remove machinery cover.
2. Remove the wing nut (4) and the remove rod (5) and battery holder (3).
3. Pull out the battery (6) toward you.
4. Disconnect the (-) terminal (7) on the ground side first and then the (+) terminal (8) to disconnect the battery cable.
5. Remove the battery (6).

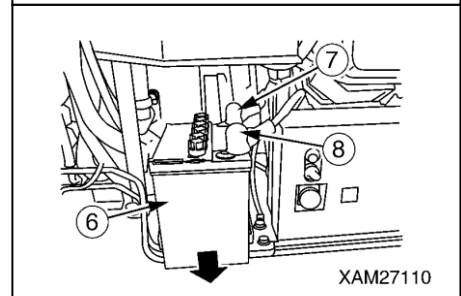
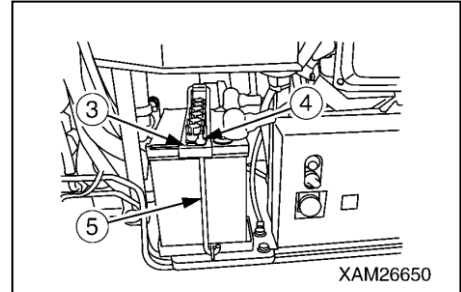

[2] INSTALLATION

- Reverse the removal procedure to install the battery.

NOTES

Connect the (-) terminal (7) on the ground side last when connecting the battery.

8.3 CAUTIONS WHEN CHARGING THE BATTERY

When charging the battery mounted to the machine

- Abnormal voltage may be applied to the alternator, resulting in the breakage. Disconnect the battery terminal wires before charging the battery.
- Remove all the fluid plugs to release the gas generated.
- Stop charging if the battery becomes overheated (fluid temperature exceeded 45 °C).
- Stop charging promptly once the charging is completed.

Charging even after the charging is completed will;

- (1) overheat the battery
 - (2) reduce the electrolyte level
 - (3) cause failures in the battery
- Never inverse the connection of [(+) terminal and (-) terminal]. Doing so can cause damage to the alternator.
 - Remove the battery cable when handling the battery other than for a battery electrolyte level check and specific gravity measurements.

8.4 STARTING THE ENGINE WITH BOOSTER CABLE

Start the engine with booster cable as described below.

[1] CAUTIONS IN CONNECTING/DISCONNECTING BOOSTER CABLE

⚠ WARNING

- Never let the (+) terminal and (-) terminal come into contact with the other when connecting the cable.
- Wear goggles and rubber gloves when starting the engine with the booster cable.
- Do not let the normal machine and machine in failure come into contact with each other.
Because the battery produces hydrogen gas, sparks around the battery can cause explosion.
- Do not make mistakes when connecting the booster cable. Note that there will be some sparks when making the last connection. Make this connection at the location as far as possible from the battery.
- Do not let the booster cable clips contact one another or the machine when disconnecting the booster cable.

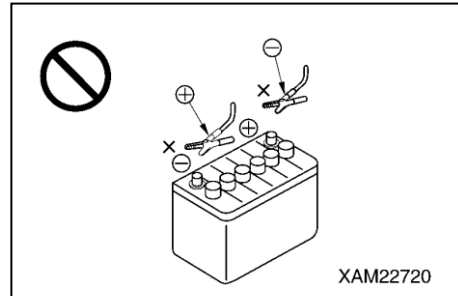

CAUTION

- Use booster cable and clips of appropriate size for the battery size.
- The battery in the normal machine and machine in failure should be of the same capacity.
- Check that the cable and clips have no breakage and corrosion.
- Connect the clips securely.
- Verify that the operation levers are at the NEUTRAL position.

[2] CONNECTING BOOSTER CABLE

Connect the booster cable in the numerical order shown in the diagram on the right.

1. Turn the starter switch of both of the normal machine and machine in failure to the OFF position.
2. Connect a clip of the booster cable (A) to the (+) terminal of the machine in failure.
3. Connect the other clip of the booster cable (A) to the (+) terminal of the normal machine.
4. Connect a clip of the booster cable (B) to the (-) terminal of the normal machine.
5. Connect the other clip of the booster cable (B) to the engine block of the machine in failure.

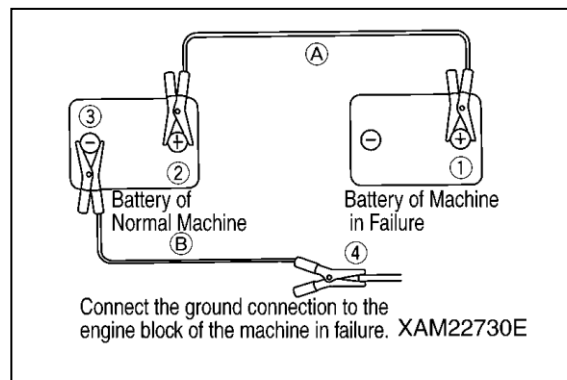

[3] STARTING THE ENGINE

⚠ CAUTION

Ensure that the operation levers are at the NEUTRAL position. If the safety lock lever is equipped, also verify that the safety lock lever is at the lock position.

1. Ensure that the clips are securely connected to the battery terminals.
2. Start the engine of the normal machine and increase the engine speed to full speed (highest speed).
3. Turn the starter switch of the machine in failure to the "START" position to start the engine.

If the engine does not start, wait at least 2 minutes before re-starting.

NOTES

See "Operation 2.2 Starting the Engine" for how to start the engine.

[4] DISCONNECTING BOOSTER CABLE

When the engine starts, disconnect the booster cable in the reverse order of connecting the booster cable.

1. Disconnect the clip of the booster cable (B) connected to the engine block of the machine in failure.
2. Disconnect the clip of the booster cable (B) connected to the (-) terminal of the normal machine.
3. Disconnect the clip of the booster cable (A) connected to the (+) terminal of the normal machine.
4. Disconnect the clip of the booster cable (A) connected to the (+) terminal of the machine in failure.

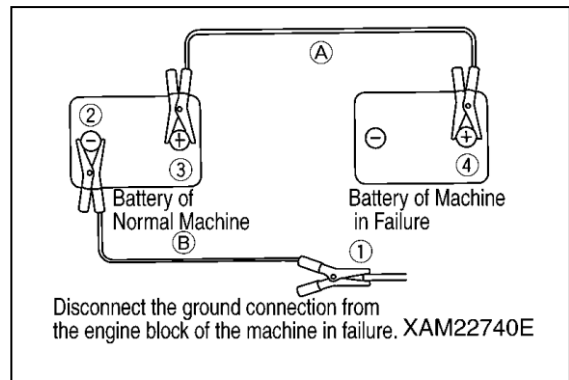

9. TROUBLESHOOTING

9.1 ELECTRICAL COMPONENTS

- Make sure that you contact us or our sales service agency for the actions indicated in parentheses in the Actions field.
- Ask our sales service agency for repair if you suspect other abnormality or causes than those given below.

Abnormal Phenomenon	Major Cause(s)	Actions
Dim light even at highest engine speed	• Defective wiring	(• Check and repair slacked terminals and open circuits)
Light blinks during engine operation	• Defective alternator • Defective wiring	(• Replace) (• Check and repair)
Battery charge lamp does not goes off even after the engine starts	• Defective alternator • Defective wiring	(• Replace) (• Check and repair)
Starter not rotating even after the starter switch is turned	• Defective wiring • Insufficient battery charge • Defective fuse	(• Check and repair) • Charge the battery • Replace the fuse
Starter pinion going out and in repeatedly (struggling)	• Insufficient battery charge	• Charge the battery
Starter motor turning slowly	• Insufficient battery charge • Defective starter	• Charge the battery (• Replace)
Starter disengaged before the engine starts	• Defective wiring • Insufficient battery charge	(• Check and repair) • Charge the battery

9.2 MACHINE BODY

- Make sure that you contact us or our sales service agency for the actions indicated in parentheses in the Actions field.
- Ask our sales service agency for repair if you suspect other abnormality or causes than those given below.

Abnormal Phenomenon	Major Cause(s)	Actions
Crane cannot operate but can travel	• Defective travelling lever stand position detector	(• Check and repair)
• Travelling speed, boom and hook block operation speed too slow • Abnormal noise from pump	• Insufficient hydraulic oil • Hydraulic oil tank strainer and element clogged	• Refill with hydraulic oil to the specified oil level, referring to the section “Check before operation” • Clean and replace the filter by referring to the “Periodical Checks”.
Hydraulic oil temperature too high	• Insufficient hydraulic oil • Clogged cooling fins	• Refill with hydraulic oil to the specified oil level, referring to the section “Check before operation” • Clean
• Rubber tracks coming off • Abnormal wear on the sprockets	• Rubber tracks too loose	• See “Check before operation” and adjust the tension

9.3 ENGINE

- Make sure that you contact us or our sales service agency for the actions indicated in parentheses in the Actions field.
- Ask our sales service agency for repair if you suspect other abnormality or causes than those given below.

Abnormal Phenomenon	Major Cause(s)	Actions
Engine does not start even after the starter key is turned	<ul style="list-style-type: none"> • Insufficient fuel • Insufficient battery charge • Fuel not available at carburetor • Defective spark plug • Firing of spark plug deficient • Insufficient compression • Engine emergency stop switch is ON position 	<ul style="list-style-type: none"> • See “Check before operation” and refuel • Charge the battery (• Check and repair) • Clean, check and replace (• Check and repair) (• Check and replace) • Operate the switch to OFF position
Engine starts but stops right away	<ul style="list-style-type: none"> • Insufficient oil in oil pan 	<ul style="list-style-type: none"> • See “Check before operation” and adjust oil level to appropriate one • See causes and actions for “Engine does not start”
Engine power is low, the power gradually drops	<ul style="list-style-type: none"> • Air cleaner element clogged • Recoil starter screen clogged • Defective spark plug • Firing of spark plug deficient • Insufficient compression 	<ul style="list-style-type: none"> • See “Periodical Maintenance” for cleaning or replacement of the parts • See “Check before operation” for cleaning • Clean, check and replace (• Check and repair) (• Check and replace)

INSPECTION AND MAINTENANCE

1. PRECAUTIONS FOR MAINTENANCE	4- 2
2. BASIC MAINTENANCE	4- 4
3. LEGAL INSPECTION	4- 6
4. CONSUMABLES	4- 6
5. LUBRICATING OIL	4- 7
6. ACCESSORY TOOLS AND STANDARD TIGHTENING TORQUE	4- 8
7. INSPECTION AND MAINTENANCE LIST	4-10
8. MAINTENANCE PROCEDURES	4-12

1. PRECAUTIONS FOR MAINTENANCE

Thorough understanding of the inspection and maintenance items is required to perform efficient inspection and maintenance that contributes to safe use of this machine.

WARNING

- Do not perform any inspection or maintenance that is not described in this manual. Potential serious accidents or machine failures may occur if it is performed at the discretion of the individual.
In the event that a judgment on the severity of a failure or malfunction is unable to be made, contact us or our sales service agency to request repair.
- In the event that a failure or malfunction is encountered in machine operation or found in inspection, report it to your employer or supervisor immediately. Contact us or our sales service agency to request repair accordingly.
- Inspection and maintenance should be performed with the machine placed on a level and strong footing.

[1] CHECK THE SERVICE METERS

Read the service meters daily to check for any maintenance item that has reached the obligatory maintenance period.

[2] USE GENUINE PARTS FOR REPLACEMENT

Always use Maeda genuine parts as specified in the parts catalogue for part replacement.

[3] USE PURE GREASE

Always use Maeda pure grease. The viscosity of grease must conform to specifications according to ambient temperature.

[4] USE CLEAN OIL AND GREASE

Always use clean oil, grease, and container to keep impurities out of them.

[5] KEEP THE MACHINE CLEAN

Keep the machine clean to facilitate the detection of a malfunction. Especially keep the grease nipple, breather, and oil level gauge (oil access door) clean to prevent impurities from finding their way into the machine.

[6] HANDLE WATER AND OIL AT ADEQUATE TEMPERATURE

Drainage, drain oil, and exhaust filter will be at elevated temperatures immediately after the machine comes to a stop. Replace drainage, drain oil, and filter only after they drop in temperature for safety.

If the oil is cold, raise the temperature of the oil to approx. 20 to 40°C.

[7] CHECK DRAIN OIL AND OIL FILTER

For replacement of oil and filter, check the drain oil and exhaust filter to make sure no a considerable amount of metal powder or foreign objects is present.

[8] CAUTIONS FOR LUBRICATION

Do not remove the strainer to lubricate if it is attached to the lubrication opening.

[9] PROTECT OIL FROM IMPURITIES

Avoid dust when inspecting and replacing the oil to keep impurities out of the oil.

[10] ATTACH A WARNING TAG

When draining coolant and oil, always attach a warning tag to the travelling operation unit for the prevention of accidental engine starting.

[11] FOLLOW SAFETY PRECAUTIONS

Safety precautions provided on the machine should always be followed when using the machine.

[12] CAUTIONS FOR WELDING REPAIRS

- Power off the machine. (Turn OFF the start switch)
- Do not continuously apply 200V or greater.
- Ground the machine within 1 meter from the welding point.
- Be sure to disconnect the connectors of the remote controller, moment limiting indicator, and moment limiting converter.
- Remove the negative terminal (-) of the battery.
- Make sure no sealing or bearing is present between the welding point and the grounding point.
Potential damage to sealing may occur due to sparks if disregarded.
- Do not ground around the boom pin or the hydraulic cylinder.
Potential damage to a plated section may occur due to sparks if disregarded.

[13] KEEP FROM FLAME

Always clean the parts with noncombustible cleaning agent or light oil.

Keep the machine from flames when using gasoline.

[14] KEEP THE ATTACHMENT SURFACE CLEAN

Be sure to clean the attachment surface after removing a part to which the O-ring and gasket sealing are attached.

Replace the part with a new one with the O-ring and gasket reattached.

[15] Empty YOUR POCKETS

Always empty your pockets before performing inspection and maintenance of the machine in a downward direction with the cover opened.

[16] ASSURE SAFE RUBBER TRACK

When performing crane operation in a rocky location, make sure of no damage to the rubber track and no looseness, cracks, abrasion of bolts and nuts. Loosen the tension of the crawler tread more than usual.

[17] CAUTIONS FOR MACHINE WASH

- Do not direct a jet of steam to the electrical parts and connector.
- Keep the operation panel dry.
- Do not apply pressurized water directly to the recoil starter.
- Wash the machine with clean cloth, rinsing off dirt and dust.

[18] PRE- AND POST-WORK INSPECTION

Before performing crane operation in the muddy water, rain, snow and on the seashore, always check plugs and valves for looseness. Post-work inspection requires a check of all the units for cracks and damages and to check bolts and nuts for looseness and coming off, with the machine washed.

Carry out early greasing. Grease the operating pins that enter muddy water on a daily basis.

[19] CAUTIONS FOR WORKING IN A DUSTY SITE

The following precautions should be observed when working in a dusty site.

- Occasionally check the air cleaner for clogging.
- Clean and replace the fuel filter in a timely manner.
- Be sure to clean the electrical parts, especially the starter and flywheel magnet, to protect them from dust.

[20] DO NOT MIX OIL

Never use different types of oil together under any circumstance.

Replace the oil entirely when replenishing a different type of oil.

Always use Maeda genuine parts for part replacement.

2. BASIC MAINTENANCE

[1] OIL HANDLING

- Oil is used under extremely harsh conditions (high temperature, high pressure) in the engine and working device, which causes the oil to undergo deterioration with operating time.

Always use oil that meets requirements such as grade and operating temperature defined in the operation manual. Be sure to perform periodic replacement of oil irrespective of contamination in the oil.

- Oil is equivalent to human blood. Exercise due caution to handle oil, keeping impurities (such as water, metal powder or dust) out of oil. Most mechanical failures are attributed to intrusion of impurities.

Extra caution is required to prevent impurities from finding their way during machine storage and lubrication.

- Do not mix oil with another oil of a different grade or brand.

- Oil lubrication must conform to the designated quantity of oil.

Failure to lubricate with an adequate quantity can lead to a machine failure.

- In the event that oil used in a working device turns cloudy, potential intrusion of moisture or air into the oil may be considered. Contact us or our sales service agency.

- When replacing oil, always replace the relevant filter as well.

- "ISO VG32" is adopted for a hydraulic oil system as factory default.

Do not use any other hydraulic oil that is not recommended by us. Failure to follow the instruction may cause the filters to get clogged. A small amount of oil remaining in piping and cylinders does not cause problems even if mixed with another oil.

[2] FUEL HANDLING

- Do not remove the strainer when replenishing fuel.

- Always use fuel that meets requirements such as grade and operating temperature defined in the operation manual.

- Ensure that the fuel tank is filled up after finishing daily work to prevent condensation of the humid air inside the fuel tank that will result in intrusion of moisture.

- Drain deposits and water out of the fuel tank before starting the engine or approximately 10 minutes after fuel replenishment.

- The air should be released from the circuit when the machine runs out of fuel or fuel filter replacement is performed.

- Clean the tank and fuel system if any foreign objects enter the fuel tank.

[3] STOCKING AND STORAGE OF OIL AND FUEL

- Stock and store oil and fuel indoors to keep impurities such as moisture or dust out of them.

- When storing oil and fuel in drums for a long time, line the drums horizontally aligning the drum bungs sideways (to store them away from moisture). Be sure to cover the drums with a waterproof sheet if storing them outside.

- To prevent deterioration of oil and fuel resulting from long-term storage, employ the first-in first-out for using oil and fuel.

[4] GREASE HANDLING

- Grease is designed to prevent the joint from rattling and making a noise.

- A nipple that is not described in the Periodic Maintenance chapter is used for overhauls, which requires no grease replenishment. Grease the nipple if long-term use hinders its smoothness.

- Wipe off old grease squeezed out after greasing. Extra care is required to wipe the parts where the adhesion of sand and dust accelerates the wearing away of the rotating part.

[5] FILTER HANDLING

- A filter is an extremely important part that keeps major equipment free from impurities in oil, fuel, and the air circuit, which prevents an associated failure. Periodic replacement of the filter is required in accordance with the Operation Manual. The replacement period should be shortened in responses to harsh operating environments or the oil used.
- Do not reuse any washed filters (cartridge type one) under any circumstances.
- After replacing an oil filter, check the used filter for any metal powder.
If check finds metal powder on the used filter, contact us or our sales service agency.
- As to a replacement filter, always unpack it immediately prior to its use.
- Always use Maeda genuine filters.

[6] ELECTRICAL PART HANDLING

- The electrical parts are susceptible to water damage and damaged coating. A current leakage is developed if the electrical parts are wet or have damaged coating, which causes the machine to go out of order and malfunction. Exercise due caution when handling the electrical parts.
- Inspection and maintenance include the checking of fuse damage, and battery electrolyte level.
- Never remove and disassemble equipment (electrical parts) from the machine.
- Only optional electrical parts that accompany the machine can be installed.
- Keep the electrical parts away from water when the machine is washed and used in the rain.
- When using the machine at the seashore, keep the electrical parts free of water and impurities to prevent corrosion.

[8] HYDRAULIC EQUIPMENT HANDLING

- Hydraulic equipment will be at elevated temperatures during and immediately after operation. Hydraulic equipment operates under high pressure. The following precautions should be observed when performing inspection and maintenance of hydraulic equipment.
 - Place the machine in travel position on a level surface to inhibit the application of pressure to the cylinder circuit.
 - Be sure to stop the engine.
 - Hydraulic oil and lubricating oil will be at elevated temperatures and high pressure immediately after equipment comes to a stop. Perform inspection and maintenance only after the oil drops in temperature for safety. An internal pressure may be exerted despite temperature drop. When removing the plugs, screws and hose joints, stand aside and gradually loosen to decompress.
 - Be sure to remove the pressure releasing air from the hydraulic oil tank before performing inspection and maintenance of the hydraulic circuit.
- Inspection and maintenance include hydraulic oil level check and replacement of the filters and hydraulic oil.
- Check the O-ring for scratches when removing the high-pressure hose. If check finds scratches, replace the O-ring.
- Air bleed of the hydraulic circuit is required after the following tasks are performed: replacement and cleaning of the hydraulic oil filter element and strainer, repair and replacement of hydraulic equipment, and hydraulic piping replacement.

3. LEGAL INSPECTION

If periodic inspection for machine safety assurance is stipulated by laws and regulations of your country, perform inspection complying with the inspection items listed below.

1. Make sure no abnormal event is present in the safety devices.
2. Check the hoisting accessories including a hook block for any abnormalities.
3. Check the winch wire rope end and wire clip for breakage.
4. Replace the wire rope promptly if it is damaged.
5. Check the hydraulic hose for oil leaks and friction flaws on the surface. Replace the hose if a surface flaw is detected.
6. Check the structural part including the boom for cracks and deformations.
7. Check the mounting bolts and joints for looseness and falling off.
8. Check if the booms perform proper operation and stop in extending, retracting, raising, lowering, and slewing.

If check finds a malfunction, contact us or our sales service agency.

4. CONSUMABLES

Consumables such as a filter element and wire rope are to be replaced upon periodic maintenance or prior to the wear limit. Proper replacement of consumables delivers increased economy in machine use.

Always use Maeda genuine parts for part replacement.

See the parts catalogue for part numbers when ordering parts.

[LIST OF CONSUMABLES]

Part	Replacement cycle
Hydraulic oil return filter, suction filter	Every 500 hrs
Cylinder gasket	★ 3 yrs
Boom slide plate	Every 3 yrs
Winch wire rope	★ Every 3 yrs
Boom extending wire rope	★ Every 3 yrs
Boom retracting wire rope	★ Every 3 yrs
Engine fuel pipe	★ Every 3 yrs

★ The cycles marked with a star “★” in Replacement cycle include a halt period.

★ Contact us or our sales service agency for part replacement.

5. LUBRICATING OIL

5.1 USE OF LUBRICATING OIL ACCORDING TO TEMPERATURES

Use of lubricating oil should vary with changes in temperature.

Lubricating place	Type of oil	Use by temperature									Specified capacity (liter)	Volume to replace (liter)
		-22 -30	-4 -20	4 -10	32 0	50 10	58 20	66 20	104 40	122 50		
Engine oil pan	Engine oil	SAE15W-40SE									1.2	1.2
		SAE10W-30SE										
Hydraulic oil tank	Hydraulic oil	ISO VG32									20	20
		ISO VG46										
Swing reducer	Gear oil	ISO VG320									0.3	0.3
Winch reducer		NIPPON OIL EUROPE LIMITED									0.8	0.8
Travel motor reducer	Engine oil	SAE30-CD									0.33	0.33
Fuel tank	Automobile gasoline	Gasol nel 98/70/EEC, 85/536/EEC									6.0	—

- A specified oil quantity is defined as a total quantity of oil including that for unit piping, and a replacement oil quantity is defined as a quantity of oil to be replaced at inspection and maintenance.
- Always use SAE15W-40SE or SAE10W-30SE to start the engine with temperature at 0°C or below despite rise in day time temperatures of approx. 10°C.
- Be sure to use our recommended abrasion-resistant hydraulic oil for the hydraulic oil system; ISO VG46 and VG32.
"Nippon Oil Super Highland 32" is adopted for a hydraulic oil system as factory default.
- Be careful not to refuel too much, otherwise, fuel may flood when the machine travels on a slope.

CAUTION

- Molybdenum disulfide filled grease is to be applied to the boom slide plate (top), both sides and bottom of the boom.
- Do not apply molybdenum disulfide filled grease to the slewing bearing.

6. ACCESSORY TOOLS AND

STANDARD TIGHTENING TORQUE

6.1 ACCESSORY TOOLS

The following tools come with this machine:

No.	Tool	Remarks
1	Box wrench for spark plug	Width across flat: 21 mm
2	Screw driver (Philips)	

6.2 STANDARD TIGHTENING TORQUE LIST

Torque the metric bolts and nuts with no specific indication to the values shown in this table.

Adequate tightening torque is determined with respect to (a) width across flat (b) of a bolt or nut.

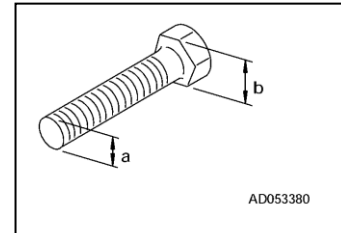

[Table 1]

Nominal size (a; mm)	Width across flat (b; mm)	[1] Bolt marked with “8.8” (strength classification) on its head		[2] Bolt marked with “10.9” (strength classification) on its head	
		Tightening torque {N•m (kgf•m)}		Tightening torque {N•m (kgf•m)}	
		Target value	Tolerance	Target value	Tolerance
6	10	7.8 (0.80)	6.8-9.0 (0.70-0.92)	11.0 (1.1)	9.4-12.7 (0.93-1.26)
8	13	19.0 (1.95)	16.5-21.9 (1.70-2.24)	27.0 (2.7)	23.0-31.1 (2.3-3.10)
10	17	37.5 (3.85)	32.6-43.1 (3.35-4.43)	53.0 (5.4)	45.0-61.0 (4.6-6.21)
12	19	65.5 (6.70)	57.0-75.3 (5.85-7.70)	93.0 (9.5)	79.0-107 (8.10-10.9)
14	22	104 (10.6)	90.4-120 (9.2-12.2)	148 (15.1)	126-170 (12.8-17.4)
16	24	163 (16.6)	142-187 (14.4-19.1)	231 (23.5)	196-266 (20.0-27.0)
18	27	224 (22.8)	195-258 (19.8-26.2)	317 (32.3)	269-365 (27.5-37.1)
20	30	318 (32.4)	277-366 (28.2-37.3)	450 (45.9)	383-518 (39.0-52.8)
22	32	432 (44.0)	376-497 (38.3-50.6)	612 (62.4)	520-704 (53.0-71.8)
24	36	549 (56.0)	477-631 (48.7-64.4)	778 (79.3)	661-895 (67.4-91.2)
27	41	804 (81.9)	699-925 (71.2-94.2)	1130 (116)	961-1300 (98.6-133)
30	46	1090 (111)	948-1250 (96.5-128)	1540 (158)	1310-1770 (134-182)
33	50	1485 (151)	1290-1710 (131-174)	2100 (214)	1790-2410 (182-246)
36	55	1910 (194)	1660-2200 (167-223)	2700 (275)	2300-3100 (234-316)

[Table 2]

Nominal size (a; mm)	Width across flat (b; mm)	[3] Bolt marked with “12.9” (strength classification) on its head		[4] Other bolts	
		Tightening torque {N•m (kgf•m)}		Tightening torque {N•m (kgf•m)}	
		Target value	Tolerance	Target value	Tolerance
6	10	13.0 (1.30)	11.1-15.0 (1.11-1.50)	3.0 (0.30)	2.6-3.5 (0.26-0.35)
8	13	31.5 (3.20)	26.8-36.2 (2.72-3.70)	7.5 (0.75)	6.5-8.6 (0.65-0.85)
10	17	62.5 (6.40)	53.1-71.9 (5.44-7.35)	14.5 (1.45)	12.6-16.7 (1.25-1.65)
12	19	109 (11.1)	92.7-125 (9.44-12.8)	25.0 (2.55)	21.7-28.8 (2.20-2.95)
14	22	174 (17.7)	148-200 (15.0-20.4)	40.0 (4.10)	34.8-46.0 (3.55-4.70)
16	24	271 (27.7)	230-312 (23.5-31.9)	62.5 (6.40)	54.3-71.9 (5.55-7.35)
18	27	373 (38.1)	317-429 (32.4-43.8)	86.0 (8.75)	74.8-98.9 (7.60-10.0)
20	30	529 (54.0)	450-608 (45.9-62.1)	122 (12.4)	106-140 (10.8-14.3)
22	32	720 (73.4)	612-828 (62.4-84.4)	166 (16.9)	144-191 (14.7-19.4)
24	36	915 (93.3)	778-1050 (79.3-107)	211 (21.5)	183-243 (18.7-24.7)
27	41	1340 (136)	1140-1540 (116-156)	309 (31.4)	269-355 (27.3-36.1)
30	46	1820 (185)	1550-2090 (157-213)	419 (42.6)	364-482 (37.0-49.0)
33	50	2470 (252)	2100-2840 (214-290)	570 (58.0)	495-656 (50.4-66.7)
36	55	3180 (324)	2700-3660 (275-373)	732 (74.5)	636-842 (64.8-85.7)

7. INSPECTION AND MAINTENANCE LIST

Inspection and maintenance items	Page
8.1 INITIAL 10 HOUR MAINTENANCE (Only the first maintenance of a new machine)	4-12
[1] GREASING MACHINE UNITS	4-24
[2] GREASING BOOM UNITS	4-26
8.2 INITIAL 25 HOUR MAINTENANCE (Only the first maintenance of a new machine)	4-12
[1] OIL REPLACEMENT IN ENGINE OIL PAN	4-27
8.3 INITIAL 50 HOUR MAINTENANCE (Only the first maintenance of a new machine)	4-12
[1] OIL REPLACEMENT IN HYDRAULIC OIL TANK	4-33
[2] REPLACEMENT HYDRAULIC OIL RETURN FILTER AND SUCTION FILTER	4-31
8.4 INITIAL 200 HOUR MAINTENANCE (Only the first maintenance of a new machine)	4-12
[1] OIL REPLACEMENT IN SLEWING REDUCTION GEAR CASE	4-35
[2] OIL REPLACEMENT IN WINCH REDUCTION GEAR CASE	4-37
[3] OIL REPLACEMENT IN TRAVELLING MOTOR REDUCTION GEAR CASE	4-38
8.5 CHECKS BEFORE OPERATION	4-12
8.5.1 CHECKS BEFORE STARTING THE ENGINE (VISIBLE CHECKS) (See Operation 2.1.1 CHECKS BEFORE STARTING THE ENGINE (VISIBLE CHECKS))	3-34
[1] CHECKING AROUND CRANE	3-35
[2] CHECKING WIRE ROPES	3-35
[3] CHECKING HOOK BLOCK	3-35
[4] CHECKING AROUND OUTRIGGERS	3-35
[5] CHECKING UNDERCARRIAGE PARTS	3-36
[6] CHECKING AROUND TRAVELLING DOLLY	3-36
[7] CHECKING AROUND ENGINE	3-36
[8] CHECKING AROUND TRAVEL OPERATION SECTION	3-36
[9] CHECKING AROUND CRANE OPERATION SECTION	3-36
8.5.2 CHECKS BEFORE STARTING THE ENGINE (See Operation 2.1.2 CHECKS BEFORE STARTING THE ENGINE)	3-37
[1] CHECKING/REFILLING OIL LEVEL IN ENGINE OIL PAN	3-37
[2] CHECKING/REFILLING FUEL LEVEL IN FUEL TANK	3-38
[3] CHECKING/REFILLING OIL LEVEL IN HYDRAULIC OIL TANK	3-39
[4] CHECKING/REFILLING OIL LEVEL IN SLEWING REDUCTION GEAR CASE	3-40
[5] CHECKING/REFILLING OIL LEVEL IN WINCH REDUCTION GEAR CASE	3-41
[6] CHECKING/REFILLING OIL LEVEL IN TRAVEL MOTOR REDUCTION GEAR CASE	3-41
[7] CHECKING/REFILLING BATTERY ELECTROLYTE LEVEL	3-42
[8] CHECKING/CLEANING RECOIL STARTER	3-43
[9] CHECKING/CLEANING ENGINE EXHAUST GAS HOLE	3-43
[10] CHECKING/CLEANING/REPLACEMENT AIR CLEANER ELEMENT	3-44
[11] CHECKING HORN FOR OPERATION	3-45
[12] CHECKING HEADLIGHT FOR OPERATION	3-45
[13] CHECKING FUSE FOR DAMAGE	3-45

Inspection and maintenance items	Page
8.5.3 CHECKS AFTER STARTING THE ENGINE (See Operation 2.1.3 CHECS AFTER STARTING THE ENGINE)	3-46
[1] CHECKING/ADJUSTING RUBBER TRACK TENSION	3-46
[2] CHECKING RUBBER TRACK FOR DAMAGE AND WEAR	3-49
[3] CHECKING OUTRIGGER OPERATION	3-50
[4] CHECKING CRANE OPERATIONS	3-51
[5] CHECKING OVER HOIST DETECTOR FOR OPERATION	3-52
[6] CHECKING MOMENT LIMITER FOR OPERATION	3-53
[7] CHECKING ENGINE EMERGENCY STOP SWITCH FOR OPERATION	3-53
[8] CHECKING ENGINE EXHAUST GAS COLOR, NOISE AND VIBRATION	3-53
8.6 IRREGULAR MAINTENANCE	4-13
[1] REPLACEMENT RUBBER TRACK	4-13
[2] REPLACEMENT WINCH WIRE ROPE	4-15
[3] CHECKING/ADJUSTMENT BOOM TELESCOPING WIRE ROPE	4-19
[4] ENGINE MAINTENANCE FOR LONG-TERM STORAGE	4-22
8.7 MAINTENANCE EVERY 50 HOURS	4-24
[1] GREASING MACHINE UNITS	4-24
[2] GREASING BOOM UNITS	4-26
[3] OIL REPLACEMENT IN ENGINE OIL PAN	4-27
[4] CHECKING/CLEANING FUEL FILTER POT	4-28
[5] CHECKING/CLEANING ENGINE SPARK PLUG	4-29
8.8 MAINTENANCE EVERY 100 HOURS	4-30
[1] CLEANING OF CARBON IN THE COMBUSTION CHAMBER	4-30
[2] INSPECTION/ADJUSTMENT ENGINE VALVE CLEARANCE	4-30
8.9 MAINTENANCE EVERY 250 HOURS	4-30
[1] CHECKING/REFILLING OIL IN TRAVELLING MOTOR REDUCTION GEAR CASE	4-30
8.10 MAINTENANCE EVERY 500 HOURS	4-31
[1] REPLACEMENT HYDRAULIC OIL RETURN FILTER AND SUCTION FILTER	4-31
8.11 MAINTENANCE EVERY 1000 HOURS	4-33
[1] OIL REPLACEMENT IN HYDRAULIC OIL TANK	4-33
[2] OIL REPLACEMENT IN SLEWING REDUCTION GEAR CASE	4-35
[3] OIL REPLACEMENT IN WINCH MOTOR REDUCTION GEAR CASE	4-37
[4] OIL REPLACEMENT IN TRAVELLING MOTOR REDUCTION GEAR CASE	4-38

8. MAINTENANCE PROCEDURES

8.1 INITIAL 10 HOUR MAINTENANCE

The following maintenance should be performed after 10-hour operation, limited to the first maintenance of a new machine.

[1] GREASING MACHINE UNITS

See “Maintenance 8.7 Every 50 Hours” for maintenance items and procedure.

[2] GREASING BOOM UNITS

See “Maintenance 8.7 Every 50 Hours” for maintenance items and procedure.

8.2 INITIAL 25 HOUR MAINTENANCE

The following maintenance should be performed after 25-hour operation, limited to the first maintenance of a new machine.

[1] OIL REPLACEMENT IN ENGINE OIL PAN

See “Maintenance 8.7 Every 50 Hours” for maintenance items and procedure.

8.3 INITIAL 50 HOUR MAINTENANCE

The following maintenance should be performed after 50-hour operation, limited to the first maintenance of a new machine.

[1] OIL REPLACEMENT IN HYDRAULIC OIL TANK

See “Maintenance 8.11 Every 1000 Hours” for maintenance items and procedure.

[2] REPLACEMENT HYDRAULIC OIL RETURN FILTER AND SUCTION FILTER

See “Maintenance 8.10 Every 500 Hours” for maintenance items and procedure.

8.4 INITIAL 200 HOUR MAINTENANCE

The following maintenance should be performed after 250-hour operation, limited to the first maintenance of a new machine.

[1] OIL REPLACEMENT SLEWING REDUCTION GEAR CASE

See “Maintenance 8.11 Every 1000 Hours” for maintenance items and procedure.

[2] OIL REPLACEMENT WINCH REDUCTION GEAR CASE

See “Maintenance 8.11 Every 1000 Hours” for maintenance items and procedure.

[3] OIL REPLACEMENT TRAVELLING MOTOR REDUCTION GEAR CASE

See “Maintenance 8.11 Every 1000 Hours” for maintenance items and procedure.

8.5 CHECKS BEFORE OPERATION

Inspections specified in this section are required to be completed prior to starting an engine first of the day. See “Maintenance 7. Inspection and Maintenance List” for the inspection and maintenance items. See “Operation 2.1 Checking before Operation” for before operation inspection items and procedure.

8.6 IRREGULAR MAINTENANCE

[1] REPLACEMENT RUBBER TRACK

WARNING

- The inside of the tension adjusting device of the rubber track is greased. Grease is under high pressure associated with the tension of the rubber track. Failure to follow precautions stated below when removing grease may lead to a serious accident due to the grease valve popping out.
- Only one full turn of the tension adjusting grease valve is allowed when loosening. The grease valve may pop out if disregarded.
- Always stand aside when conducting tension adjustment of the grease valve to circumvent potential dangers.
- Ensure that grease is completely removed from the inside of the rubber track before rotating the sprocket to remove the rubber track.

[REMOVAL RUBBER TRACK]

- Have a steel pipe available.
1. See “Operation 2.13 Outrigger Set Up Operation” to set up the outriggers and raise the rubber track for about 50mm from the ground.

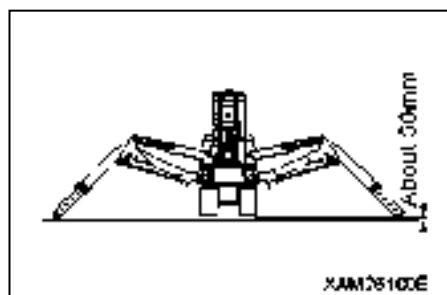

2. Remove the 2 mounting bolts (2) and remove the inspection cover (1).

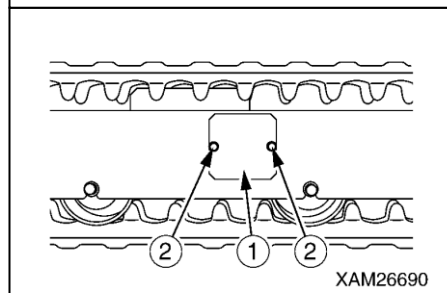

3. Loosen the grease valve (4) gradually and remove grease.

NOTES

Provide only one full turn of the grease valve (1).

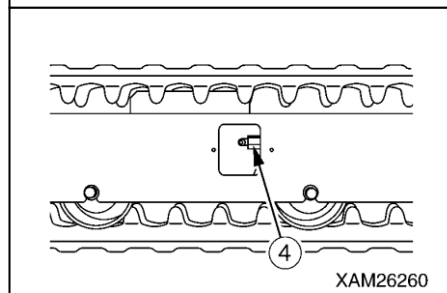

4. Insert the steel pipe between the idler and rubber track, as shown at right. Rotate the sprocket forward.
5. When the inserted steel pipe detaches the rubber track from the idler, slide the crawler in a lateral direction to remove it.

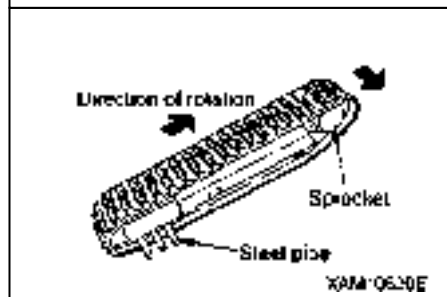

[INSTALLATION RUBBER TRACK]

- Have a grease gun available.
 - Have a steel pipe available.
1. See “Operation 2.13 Outrigger Set Up Operation” to set up the outriggers and raise the rubber track again for about 50mm from the ground.
 2. With the rubber track engaged with the sprocket, put the crawler on the idler.
 3. With the sprocket rotating forward, push the rubber track in to stop rotation.
 4. Insert the steel pipe between the idler and rubber track again, and re-rotate the sprocket to put the crawler on the idler properly.
 5. Stop rotation, and ensure that the rubber track is on the sprocket and idler properly.
 6. Make a tension adjustment to the rubber track according to “Operation 2.1.3 Checks After Starting The Engine [1] Checking/adjustment Rubber Track Tension” in the Operation.
 7. Ensure that adequate engagement and tension of the rubber track, sprocket, and idler are obtained.
 8. See “Operation 2.23 Outrigger Stowing Operation” to stow the outriggers and lower the machine on the ground.

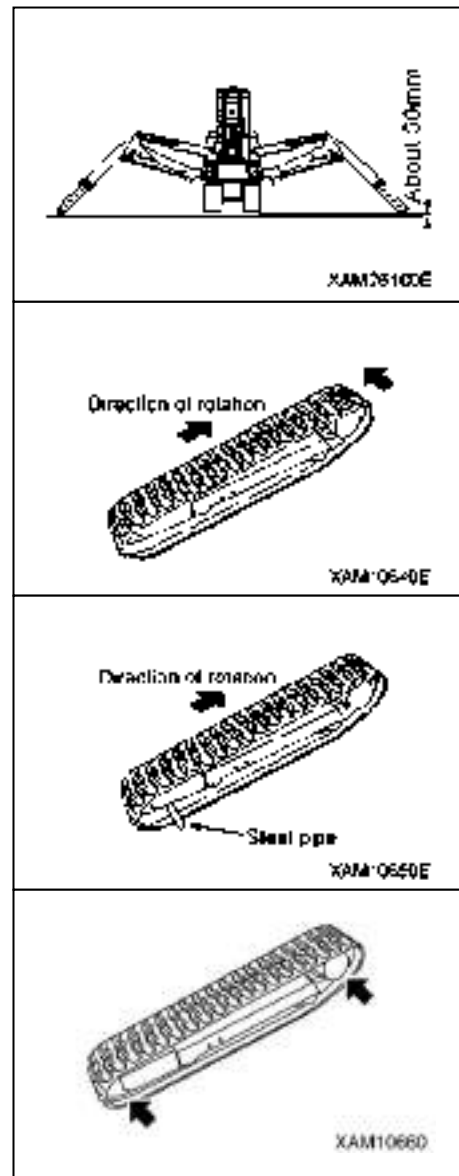

[2] REPLACEMENT WINCH WIRE ROPE

[BENCHMARK FOR REPLACING WIRE ROPES]

⚠ WARNING

Always wear work leather gloves when replacing the wire rope.

CAUTION

- The benchmark for replacing wire ropes is common to all the wire ropes for winching, telescoping the boom, and slinging.
- Measure the wire rope diameter at the section where the rope repeatedly passes through the sheave. Measure from three directions and average the value.
- Do not use the old wire ropes even if they had not been used.
- See “Maintenance 8.6 [2] Replacement Winch Wire Ropes” for how to replace the wire rope.
- Contact us or our sales service agency for replacing/repairing the wire ropes.

[WIRE ROPE NOMINAL DIMENSION]

- Wire rope for winching : IWRC 6 x Ws (29) 0/0 ϕ 6 x 35 m
- No. 4 wire rope for extending boom: IWRC 6 x Fi (29) 0/0 ϕ 8 x 3.73 m
- No. 4 wire rope for retracting boom: IWRC 6 x Fi (29) 0/0 ϕ 6 x 6.19 m

[BENCHMARK FOR REPLACING WIRE ROPES]

Wire ropes fatigue as time goes by.

Change the wire ropes when they show the following signs.

- In one twist (6 crests), 10% or more of the wires (excluding the filler wires) are broken.

NOTES

Change winching/boom telescoping wire rope when 13 or more wires are broken.

- The diameter of the wire rope is worn at 7 % or more of the nominal diameter.

NOTES

- Change the 8-mm diameter wire rope when it is reduced to 7.5 mm.
- Change the 6-mm diameter wire rope when it is reduced to 5.6 mm.

- The rope is twisted and has some kinks.
- The rope shows remarkable deformation or corrosion.
- The rope shows some abnormality at the ends.

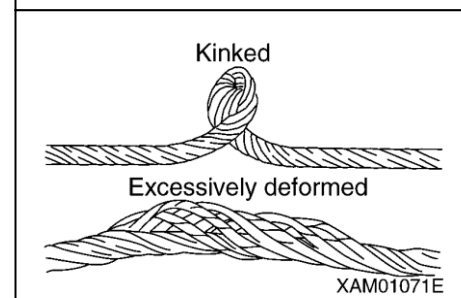
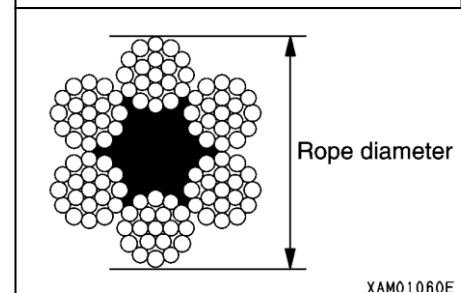
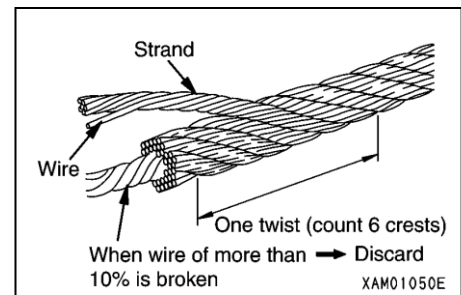

[REMOVAL WINCH WIRE ROPE]

Use the following procedure to remove the wire rope.

1. Place the machine on a level and solid surface.
2. Place the boom telescoping lever in the "Extend" position (push forward) to extend the boom slightly.
3. Place the winch lever in the "Down" position (push forward) to lower down the hook block to the ground.

4. Undo the wedge socket fixing bolt (2) and remove the wedge socket (3).

5. Remove the wire clip (4).

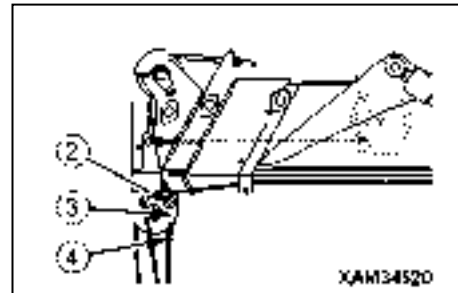

6. Pull the wire rope (5) out of the wedge socket (3), following the procedure provided below.

- (1) Bring a 4 to 6mm round bar (6) into contact with the rope wedge (7).
- (2) Remove the rope wedge (7), lightly tapping the round bar (6) with a hammer in the direction indicated by the arrow (a).

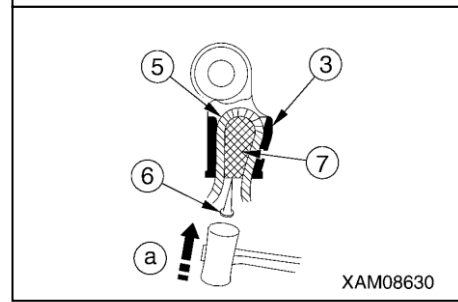

7. Place the winch lever in the "Down" position (push forward) to wind up the wire rope (5) from the winch drum.

8. With the wire rope wound off from the winch drum, detach the end of the wire rope (5) from the winch drum (8) by following the procedure provided below.

- (1) Bring a 4 to 6mm round bar (6) into contact with the rope wedge (9).
- (2) Remove the rope wedge (9), lightly tapping the round bar (6) with a hammer in the direction indicated by the arrow (b).

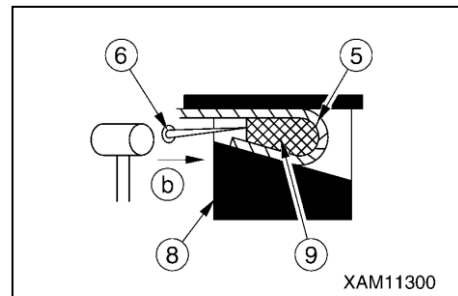

9. Wind off the remaining wire rope (5) completely.

Removal of the winch wire rope is completed.

[INSTALLATION WINCH WIRE ROPE]

⚠ WARNING

Be sure to attach the rope wedge properly to secure the wire rope. Potential serious accident may occur due to detachment of the wire rope during crane operation if disregarded.

CAUTION

- Avoid irregular winding of the wire rope on the winch drum.
- Always hoist an object (2.9 to 4.9KN {300 to 500kg}) with the boom extended and raised fully immediately after attaching a new rope. Repeat raising and lowering the hook several times until the new rope conforms.
- The wire rope is coiled. Exercise caution not to form a kink in the rope when winding it up. Be sure to unrope by rotating the rope to pull it out of the storage drum.

Use the following procedure to attach the wire rope.

1. With the end of the wire rope held, draw the wire rope (5) through the weight of the over hoist detector, load sheave (1) at the boom end, guide sheave (3) of No.1 boom, and idler sheave (2) of No.1 boom.

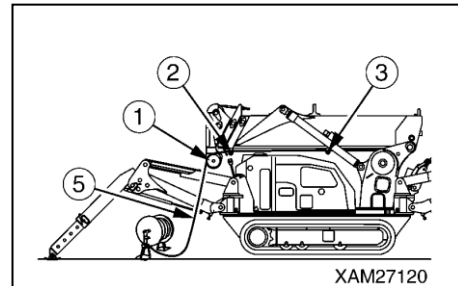

2. Draw the wire rope (5) through the attachment hole of the winch drum (8). Secure the wire rope (5) to the winch drum (8), following the procedure provided below.

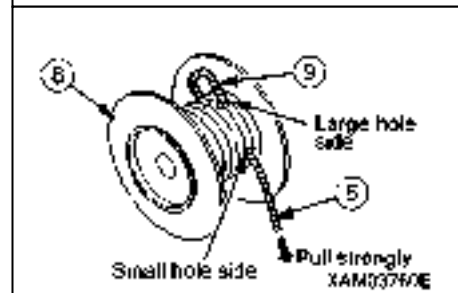

(1) Draw the wire rope (5) through the winch drum (8) with the rope loose.

(2) The rope wedge (9) should be in position (a). Pass the wire rope (5) around the rope wedge and yank at the rope in the direction indicated by the arrow.

Adjust the length of the wire rope (5) to keep the end of the wire rope from protruding from the narrow hole in the winch drum (8).

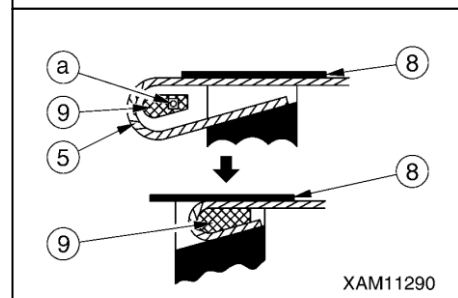

3. Place the winch lever in the "Up" position (pull toward you) slowly to wind up the wire rope (5) on to the winch drum (8).

4. In response to the number of falls (4-falls), draw the wire rope (5) through the load sheave at the boom end, hook block sheave, guide sheave, and weight of the over hoist detector.

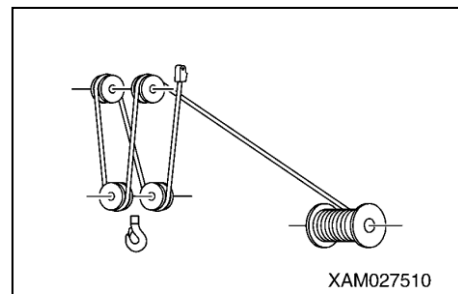

5. Secure the end of the wire rope (5) to the wedge socket (3), following the procedure provided below.

(1) Draw the wire rope (5) through the wedge socket (3) as shown on the right.

(2) With the rope wedge (7) in position (a), yank at the wire rope (5) in the direction indicated by the arrow.

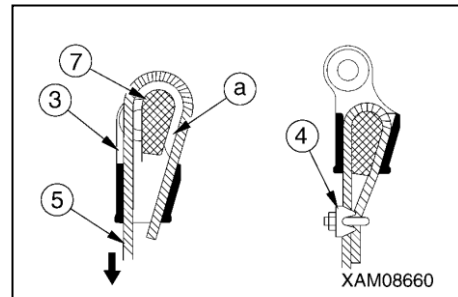

6. Attach the rope clip (4) to the wire rope (5).

7. Secure the wedge socket (3) to the boom, and tighten the wedge socket pin fixing bolt (2).

8. Place the boom derricking lever in the “Raise” position (pull toward you) or the boom telescoping lever in the “Extend” position (push forward) to raise the hook block.

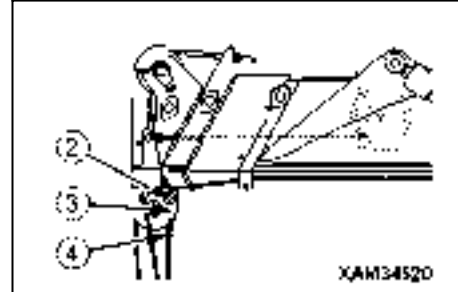

NOTES

Winch operation is allowed only after the hook block is raised.

9. With the boom extended and raised fully, place the winch lever in the “Down” position (push forward) to adjust the wire rope (5) until 3 to 4 turns of wire are left in the winch drum (8).

10. With the wire rope (5) held under tension, place the winch lever in the “Up” position (pull toward you) to wind up the wire rope (5) on to the winch drum (8).

[3] CHECKING/ADJUSTMENT BOOM TELESCOPING WIRE ROPE

⚠ WARNING

Always wear work leather gloves when replacing the wire rope.

[CHECKING BOOM TELESCOPING WIRE ROPE]

When the telescoping wire rope (1) shows a condition as shown in the figure below, adjust is as follows:

1. Keep the boom level and check whether the center of the telescoping wire rope (1) sags during the boom retracting operation.

When it sags, refer to the next section, "Adjustment of Boom Telescoping Wire Rope".

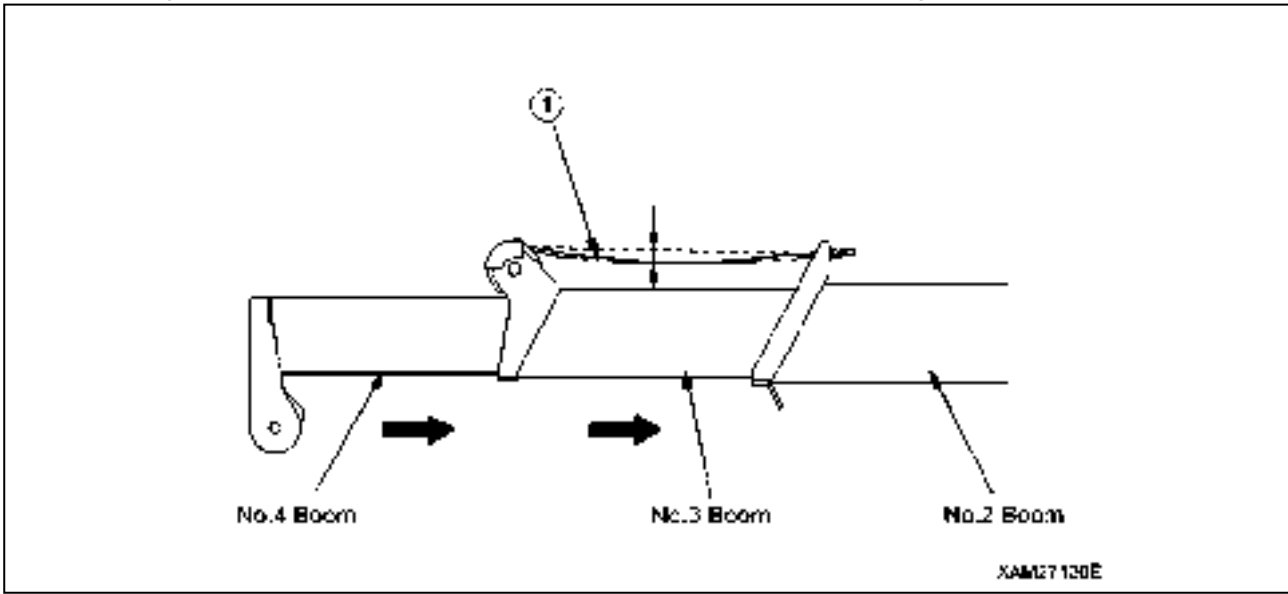

2. Check that 5mm clearance is formed between booms No.3 and No.4, clearance (a) shown at right, with the booms retracted in a horizontal position.

If check finds clearance of 5mm or more, perform proper adjustment according to "Adjustment of boom telescoping wire rope".

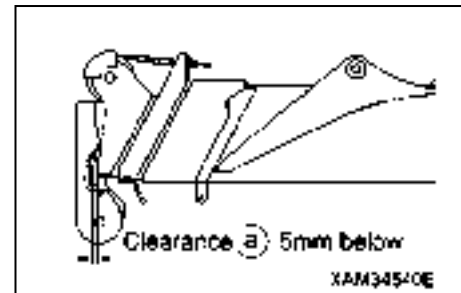

[ADJUSTMENT OF BOOM TELESCOPING WIRE ROPE]

CAUTION

The wire ropes must be adjusted to the correct tightness.

A boom extending wire rope (1 piece) and retracting wire rope (1 piece) are used in this machine. Adjustment of these wire ropes must conform to the specified procedure. Use the following procedure for wire rope adjustment.

1. With the booms retracted in a horizontal position, extend the telescoping booms approx. 2m.

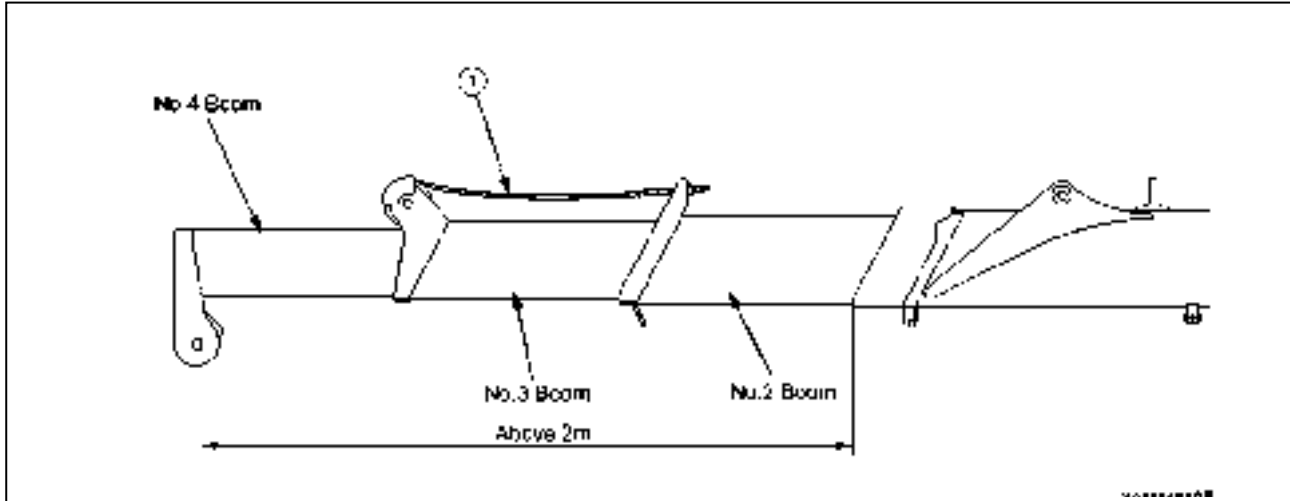

2. Retract the booms completely. Slow boom retraction is required. Measure clearance (a) to check the following for proper adjustment.

- If 5mm or more clearance (a) is formed, adjust the retracting wire rope (6). See step 3 “Adjustment of boom retracting wire rope (1)”.
- If no clearance (a) is formed, adjust the extending wire rope (1). See step 4 “Adjustment of boom extending wire rope (1)”.

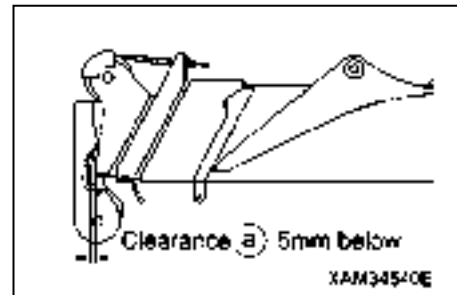

3. Adjustment of boom retracting wire rope (6)

- (1) Remove the 3 mounting bolts (5) and remove the boom top cover (4).

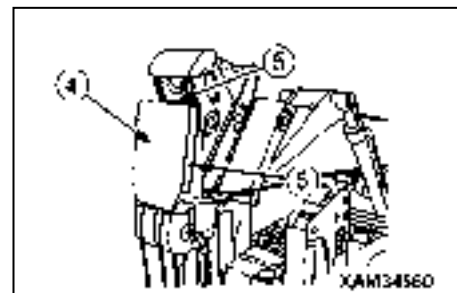

- (2) With the lock nut (7) loose, turn the adjusting nut (8) in the direction that the retracting wire rope (6) becomes tight (clockwise) to provide laterally even tightening until clearance (a) is bridged.

- (3) If the retracting wire rope remains sagging or 5mm or more clearance remains present after performing steps 1 and 2, readjustment is required.

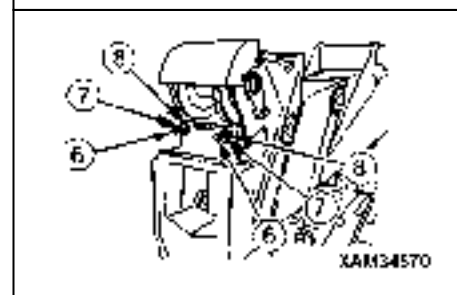

4. Adjustment of boom extending wire rope (1)

- (1) With the lock nut (2) loose, turn the adjusting nut (3) in the direction that the extending wire rope (1) becomes tight (clockwise) to provide tightening to the verge of the extension of No.4 boom.
- (2) Provide retightening to both adjusting nuts (8) of the boom retracting wire rope (6) one turn each.
- (3) Secure the adjusting nut (3) of the boom extending wire rope (1) with the lock nut (2).
- (4) Secure the adjusting nut (8) of the boom retracting wire rope (6) with the lock nut (7).
- (5) Install the boom top cover (4) to original position and tighten the mounting bolts (5) securely.

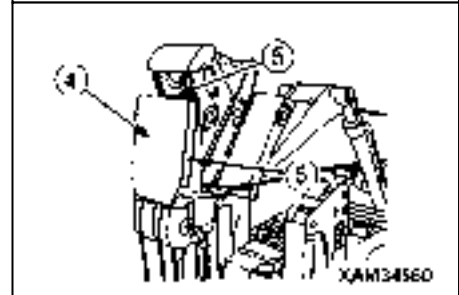
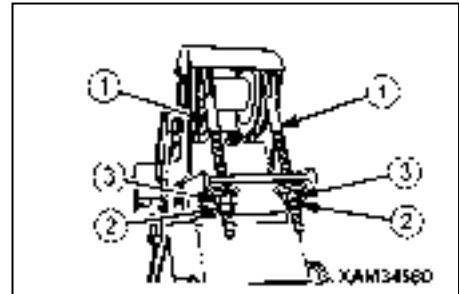

[4] ENGINE MAINTENANCE FOR LONG-TERM STORAGE

⚠ DANGER

- This machine uses gasoline (Octane number between 89 and 92). Be extremely careful with fire such as cigarette.
- To drain the fuel, always stop the engine and allow it to be sufficiently cooled.
When fuel is drained in a condition just after the engine stops and it remains still hot, spilled fuel may ignite when it touches hot parts, such as a muffler. Wipe fuel off cleanly whenever it spills.
- For a long-term storage of the machine, drain all the fuels in the tank, carburetor and other fuel systems. Such practice not only protects deterioration of the fuel system but also prevents unforeseen fire due to the change of environment during the storage.

1. Place the machine on a level and firm surface.
2. See "Operation 1.6 Machinery Cover" to remove the machinery cover.
3. Place a drain pan directly underneath the fuel filter pot (1) to receive drained fuel.
4. Turn the lever (2) on the head (3) to a horizontal position (Close position) to stop fuel supply.
5. Turn the filter pot (1) and remove the filter pot (1) from the head (3).
6. Turn the lever (2) on the head (3) to a vertical position (Open position) to drain fuel.
7. After draining fuel, install the filter pot (1) to the head (3).
8. Place a drain pan directly underneath the drain plug (5) of the carburetor (4) to receive drained fuel.
9. Turn the drain plug (5) on the carburetor (4) with screw driver (Philips) and drain fuel to the drain pan.
10. After draining fuel, turn the drain plug (5) on the carburetor (4) with screw driver (Philips) to tighten it.
11. Remove the spark plug (6) and put a small amount (2 to 3 drops) of the engine oil through the hole.
12. Pull the knob of the recoil starter (1) toward you several times, then attach the spark plug (6).
13. Pull the knob of the recoil starter (1) toward you again and stop it when you feel compression.
14. See "Operation 1.6 Machinery Cover" to install the machinery cover.

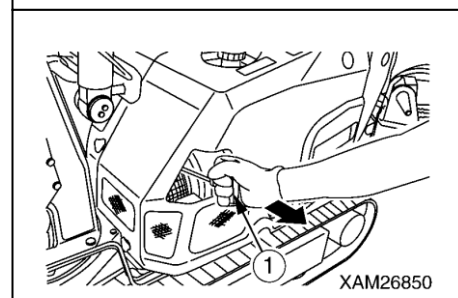
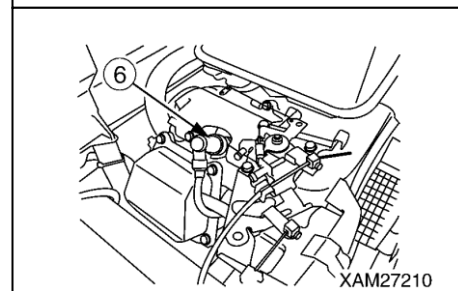
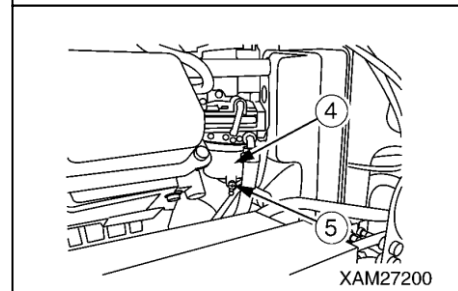
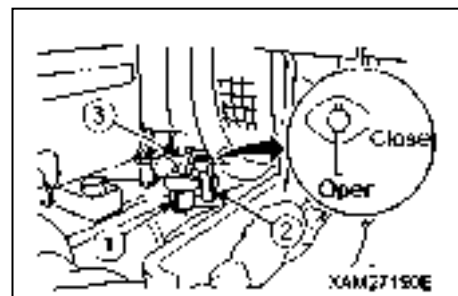

8.7 MAINTENANCE EVERY 50 HOURS

[1] GREASING MACHINE UNITS

CAUTION

- Grease type varies with greasing points. Failure to grease properly may cause the machine to shorten its useful life. See the following table for grease types.
- Greasing a new machine is required once every 10 hours until the machine attains the first 100 hours of operation that initial fit emerges.

- Use proper grease specified below according to the greasing points.

No	Greasing point		Grease type
1	Greasing of the boom mounting pin	1 place	Lithium grease
2	Greasing of the derricking cylinder bottom mounting pin	3 places	
3	Greasing of the derricking cylinder rod mounting pin	3 places	
4	Greasing of the outrigger rotary shaft	4 places	
5	Greasing of the outrigger top mounting pin	4 places	
6	Greasing of the outrigger cylinder rod mounting pin	4 places	
7	Greasing of the outrigger cylinder bottom mounting pin	4 places	
8	Greasing of the slewing gear	2 places	
9	Greasing of the winch drum	1 place	
10	Greasing of the boom telescoping wire rope	2 pieces	Rope oil
11	Greasing of the winch wire rope	1 piece	

1. With the use of the grease gun, grease the greasing points (No.1 to 9) specified in the above table through corresponding grease plugs. (See the following page)
2. Wipe off old grease squeezed out after greasing.
3. Place the outriggers when greasing the outrigger cylinders.
4. Place the boom derricking lever in the "Raise" position (pull toward you) to raise the boom slightly for greasing the derricking cylinder mounting pin.
5. Place the boom telescoping lever in the "Extend" position (push forward) to extend the boom for wire rope.
6. Apply red rope grease to prevent wire rope abrasion and rust formation.
With the rope surface cleaned, grease the rope with a brush.

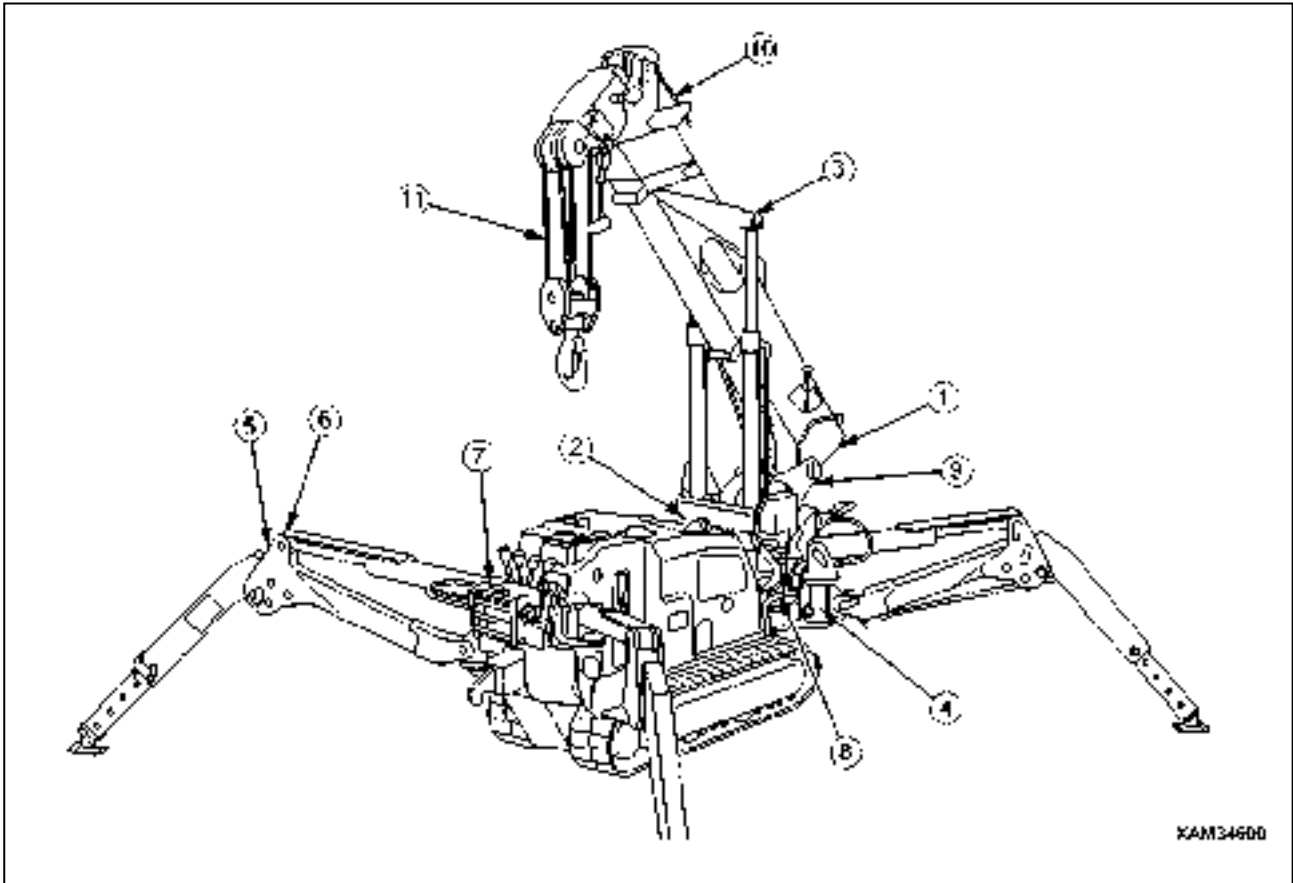

XAM34600

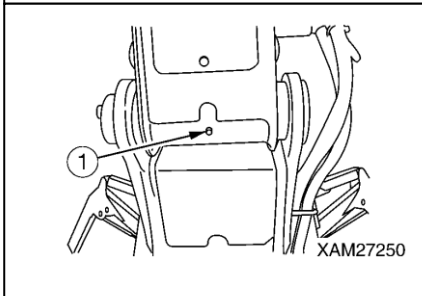

XAM27250

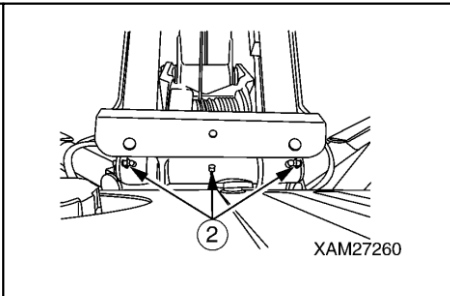

XAM27260

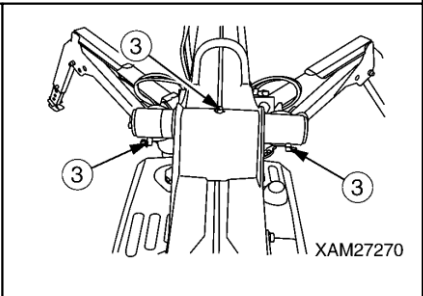

XAM27270

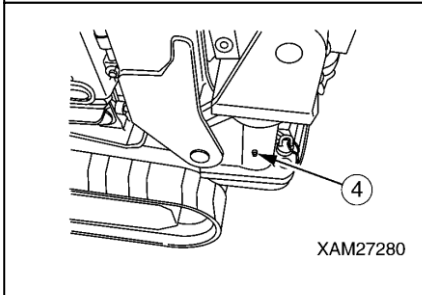

XAM27280

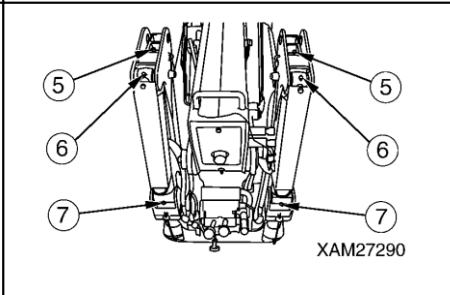

XAM27290

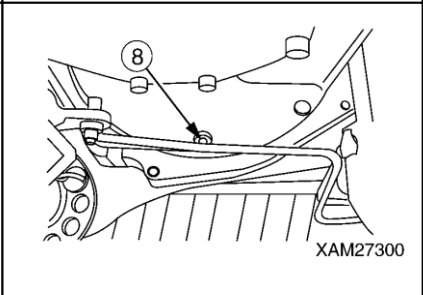

XAM27300

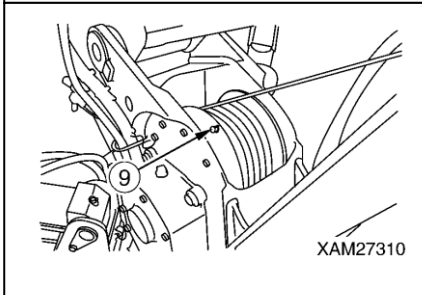

XAM27310

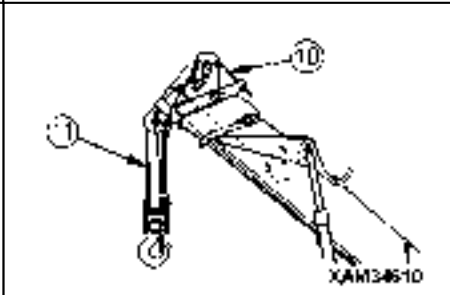

XAM34610

[2] GREASING BOOM UNITS

CAUTION

- Grease type varies with greasing points. Failure to grease properly may cause the machine to shorten its useful life. See the following table for grease types.
- Greasing a new machine is required once every 10 hours until the machine attains the first 100 hours of operation that initial fit emerges.

- Use proper grease specified below according to the greasing points.

No	Greasing point		Grease type
10	Greasing of top side of the boom slide plate	6 places	Molybdenum grease
11	Greasing of both sides and bottom of a boom	Each boom	

- Grease the slide plates on the boom top surface using the following procedure.

- (1) Place the boom telescoping lever in the "Retract" position (pull it toward you) to retract the boom fully.
- (2) With the use of the grease gun, grease the 6 grease plugs.

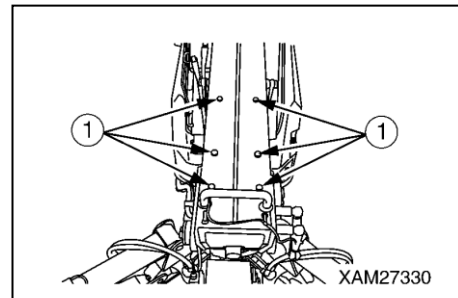

- Grease the both sides and bottom of the boom using the following procedure.

- (1) Place the boom telescoping lever in the "Retract" position (push it toward the front) to retract the boom fully.
- (2) With the use of the scraper, grease both side surfaces and bottom surface of the boom.

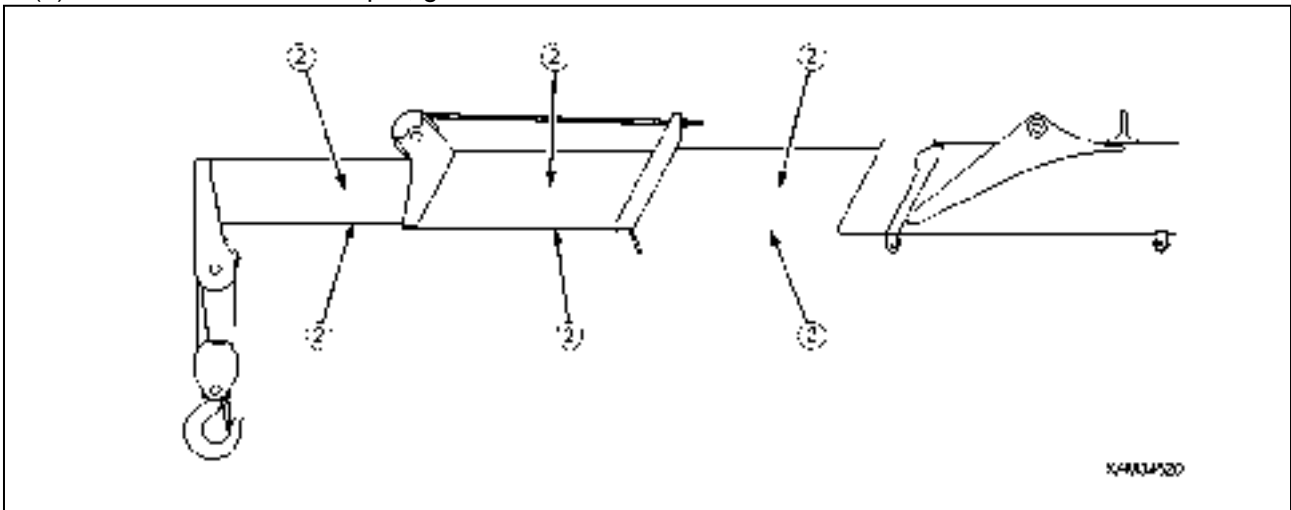

[3] OIL REPLACEMENT IN ENGINE OIL PAN

⚠ CAUTION

- Make sure the oil level gauge is secured properly after inspection and replenishment of the oil. Potential fall of the oil level gauge during operation may occur if disregarded, which could cause boiling oil to gush resulting in burns.
- All the parts will be at elevated temperatures immediately after engine operation, which urges you not to replace oil. Always perform replacement with the engine cold to touch.

CAUTION

- Be sure to use oil specified in section 5.1 “Use of Lubricating Oil according to Temperatures” in Inspection and Maintenance. Failure to use proper oil may cause the engine to shorten its useful life. Always use the specified oil for replenishment.
- The engine oil level must be maintained at the proper amount.
- The complete draining of oil is disabled if the engine becomes cold completely. Oil draining is allowed when the engine is cold to touch.
- Keep impurities out of the filler cap when replenishing oil.

- Oil drain pan: A 2-litre container
 - Quantity of oil for replacement: 1.2 litres
1. Place the machine on a level surface.
 2. Place a drain pan directly underneath the drain plug (P) at the bottom of the machine left side to receive drained oil.
 3. Remove the drain plug (P) slowly to drain the oil, keeping from contact with draining oil.
 4. Check the drained oil. If check finds a considerable amount of metal powder and foreign objects, contact us or our sales service agency.
 5. Put in the drain plug (P) and secure it.
 6. Pull the oil level gauge (G) out and wipe the oil with a disposable cloth.
 7. Refill the engine oil to the specified level, from the port where the oil level gauge was attached. When the oil is refilled to near the mouth of the port, the specified level is achieved.
 8. Insert the oil level gauge (G) into the oil filler and pull it out.

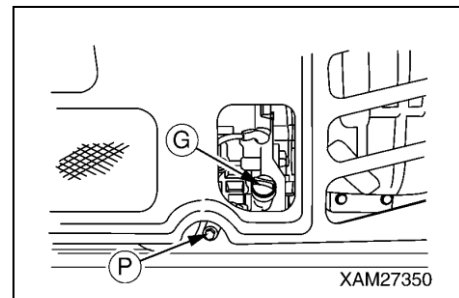

NOTES

**Don't screw in the oil level gauge (G).
That causes oil to be filled higher than correct level.**

9. Make sure the oil level is in the range “H” to “L” marked on the oil level gauge (G).
10. After oil replacement, securely install the oil level gauge (G).

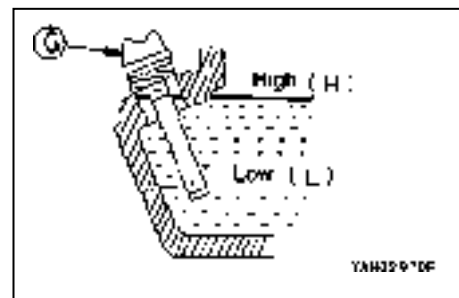

[4] CHECKING/CLEANING FUEL FILTER POT

⚠ WARNING

- The fuel filter pot has fuel (gasoline) inside. Be extremely careful of fire such as cigarette when cleaning the fuel filter pot.
- If the fuel spills when the fuel filter pot is removed, thoroughly wipe it off.

CAUTION

Water or dust accumulated inside the fuel filter pot will cause engine failure. Check inside the cup and remove any water or dust accumulated inside.

1. Place the machine on a level surface.
2. See "Operation 1.6 Machinery Cover" to remove the machinery cover.
3. Check the fuel filter pot (1) inside to make sure that there is no water or dust remaining in it.
4. If any water or dust is found to remain inside the filter pot, clean the pot internals in the following procedure.
 - (1) Turn the fuel lever (2) to horizontal position (Close) to stop fuel flow.
 - (2) Turn the filter pot (1) and remove the filter pot (1) from the head (3).
 - (3) Discard any fuel or water in the filter pot (1).
 - (4) Detach the filter net (4) in the filter pot (1) and remove all the dirt and dust adhered to the net.
 - (5) Return the filter net (4) to the filter pot (1), use the packing (5) and fit the filter pot (1) to the head (3).
 - (6) Turn the fuel lever (2) to vertical position (Open) to open the fuel circuit.

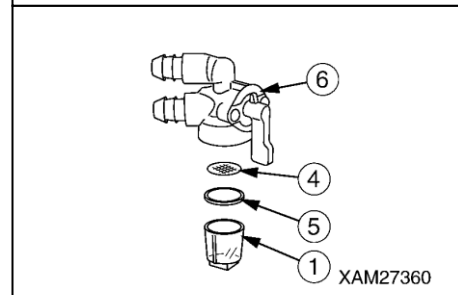
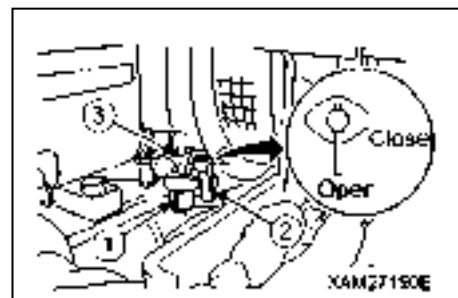

NOTES

To fasten the filter pot (1) to the head (3), a retainer ring (6) is used. To unfasten the filter pot (1), turn the retainer ring (6) counterclockwise. To fasten filter pot (1), turn the retainer ring (6) clockwise.

5. See "Operation 1.6 Machinery Cover" to install the machinery cover.

[5] CHECKING/CLEANING ENGINE SPARK PLUG

CAUTION

Make sure that the specified plug is used.
Those other than specified may cause deficiency in or shorten the useful life of engine.
• Specified spark plug: NGK BPR6HS

- Box wrench and handle for spark plug removal
 - Plug cleaner or wire brush for cleaning
1. See "Operation 1.6 Machinery Cover" to remove the machinery cover.
 2. Remove the spark plug wiring socket (1) (1 piece).
 3. With the handle threaded through the hole in spark plug box wrench, remove the spark plug.
 4. Remove carbon off the spark plug by means of the plug cleaner or the wire brush.

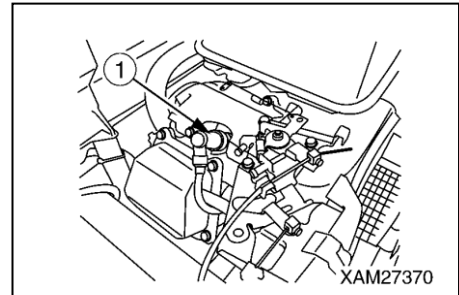

NOTES

Do not use a file or the like for this purpose as it wears electrode.

5. Measure the gap of the spark plug.
Standard value of the gap: 0.6 to 0.7mm
6. If the gap is off the standard, change the bending of negative side to place the gap in the standard range.
7. Install the spark plug to the original position and connect the spark plug wiring socket (1).
8. See "Operation 1.6 Machinery Cover" to install the machinery cover.

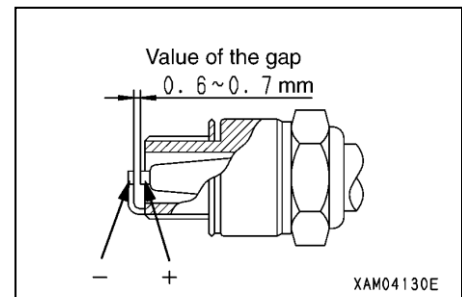

8.8 MAINTENANCE EVERY 100 HOURS

Perform this maintenance in tandem with maintenance every 50 hour.

[1] CLEANING OF CARBON IN THE COMBUSTION CHAMBER

Cleaning of carbon require special tools.

Contact us or our sales service agency to request inspection and repair.

[2] INSPECTION/ADJUSTMENT ENGINE VALVE CLEARANCE

Inspection and adjustment of valve clearance require special tools.

Contact us or our sales service agency to request inspection and repair.

8.9 MAINTENANCE EVERY 250 HOURS

Perform this maintenance in tandem with maintenance every 50/100 hours.

[1] CHECKING/REFILLING OIL LEVEL IN TRAVELLING MOTOR REDUCTION GEAR CASE

CAUTION

- See “Maintenance 5.1 Use of Lubricating Oil According to Temperature” for which oil to be used.
- Use seal tape, etc. at the thread of the oil level check plug to stop the oil leak and securely tighten the plug after refilling with the oil.

1. Move the machine forward and backward so that drain plug (P) of the travelling motor reduction gear case will come to the bottom.
2. Remove the oil level check plug (G) of the travelling motor reduction gear case to check if the oil will come out of the plug hole.
3. If there is not sufficient oil, pour in engine oil from the plug hole (G).

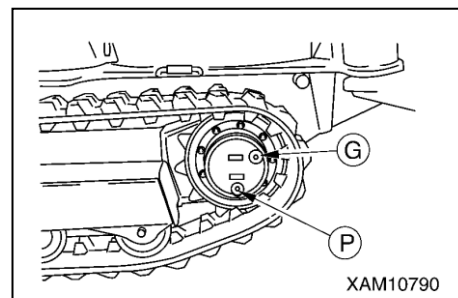

NOTES

Pour in the engine oil until the oil comes out of the oil level check plug (G).

4. Install the oil level check plug (G) and drain plug (P) and securely tighten them after checking and refilling with the oil.

8.10 MAINTENANCE EVERY 500 HOURS

Perform this maintenance in tandem with maintenance every 50/100/250 hours.

[1] REPLACEMENT HYDRAULIC OIL RETURN FILTER CARTRIDGE AND SUCTION FILTER

⚠ WARNING

- All the parts will be at elevated temperatures immediately after engine operation, which urges you not to replace the filter. Always perform replacement with the engine cold.
- The oil may spout out when the cap of the hydraulic oil tank is removed.
Loosen the bolts so that the cap is raised a little to allow the release of inner pressure, then remove bolts and remove the cap
- Securely tighten mounting bolts of the oil filler cap after refilling with the oil. If the mounting bolts loose and then filler cap falls during the operation, the hot oil spouts out of the pan, causing burns. Also, when attaching the oil filler cap, always fit a rubber packing, otherwise, when the rubber packing is neglected, the hot oil may spout out of the filler cap fitting, causing burns.

CAUTION

- See “Maintenance 5.1 Use of Lubricating Oil According to Temperature” for which oil to be used.
- Place the machine in travel position for oil quantity inspection. Oil quantity inspection with the machine in working position may deceive your eyes to deem the quantity of oil low. Owing to improper judgment, the oil may be supplied at an excessive amount.
- The engine must be at halt until piping and hydraulic equipment is filled with oil after replacement of the hydraulic oil filter.
- Avoid that oil exceeds the level point (red point) of the level gauge.
When the oil goes beyond the correct level, it may spout out from the air breather, during travelling or crane operation.
- Keep impurities out of the filler cap when replenishing oil.
- Refer to “Operation 1.6 Machinery Cover” and remove the machinery cover in accordance with the instructions in it, when necessary.

1. Place the machine on a level surface.
2. See “Operation 2.5 Machine Travelling Position” and put the machine in the “travelling position”.
3. Remove the 4 mounting bolts (1) and remove the filler cap (F) on top of the hydraulic oil tank.
4. Remove the 8 mounting bolts (5) and remove the flange (2) on top of the hydraulic oil tank and suction filter (3) from inside the hydraulic oil tank.
5. Insert the new suction filter (3) to the inside of the hydraulic tank.
6. Put the flange (2) in place with liquid packing applied to the packing (4). Secure the flange (2) with the 8 mounting bolts (5).

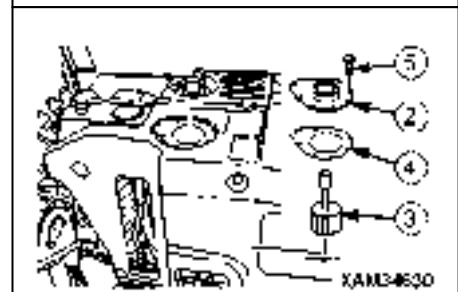
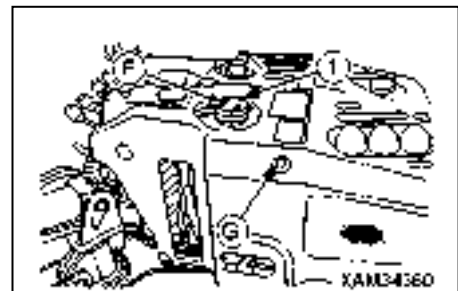

NOTES

Wipe off the oil completely if spilled.

7. Remove the 4 mounting bolts (8) and remove the hydraulic oil return filter (6) on top of the hydraulic oil tank.

8. Put the new hydraulic oil return filter (6) in place with liquid packing applied to the packing (7). Secure the hydraulic oil return filter (6) with the 4 mounting bolts (8).

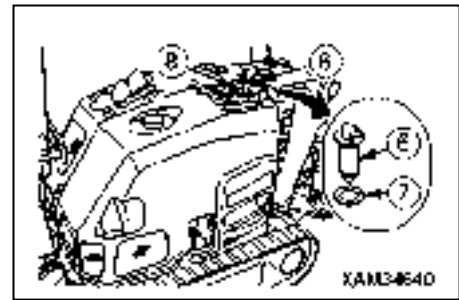

NOTES

Wipe off the oil completely if spilled.

9. Check the oil level gauge (G) and ensure that oil is sufficient to reach the level point (red dot).

10. After refilling with oil, Set the filler cap (F) and rubber packing to the filler opening position and tighten the 4 mounting bolts (1) securely.

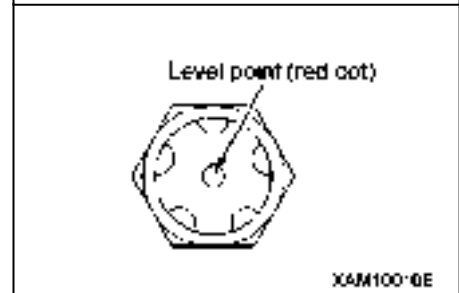
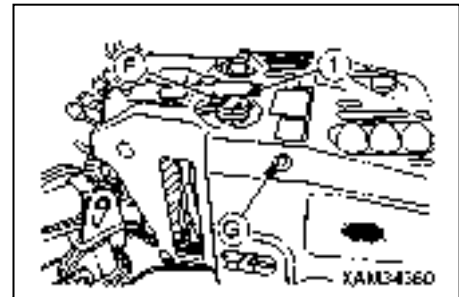

11. Use the following procedure for air bleeding.

(1) Start the engine with piping and hydraulic equipment filled with oil.

Make sure the engine runs at low idle for 10 minutes.

(2) Move the cylinders and winch motor slowly with a crane control lever at low idle speed.

Always stop the boom derricking cylinder and telescoping cylinder approx. 100mm back from the stroke end when operating the cylinders.

Repeat this task 4 to 5 times.

(3) Allow all the outriggers to be extended, referring to "Operation 2.13 Outrigger Set Up Operation".

Extend and retract the outrigger cylinder, keeping the machine down on the ground.

Always stop the outrigger cylinder approx. 100mm back from the stroke end when operating the cylinder.

Repeat this task 4 to 5 times.

8.11 MAINTENANCE EVERY 1000 HOURS

Perform this maintenance in tandem with maintenance every 50/100/250/500 hours.

[1] OIL REPLACEMENT IN HYDRAULIC OIL TANK

⚠ WARNING

- All the parts will be at elevated temperatures immediately after engine operation, which urges you not to replace the filter. Always perform replacement with the engine cold.
- The oil may spout out when the cap of the hydraulic oil tank is removed.
Loosen the bolts so that the cap is raised a little to allow the release of inner pressure, then remove bolts and remove the cap.
- Securely tighten mounting bolts of the oil filler cap after refilling with the oil. If the mounting bolts are loose and then filler cap falls during the operation, the hot oil spouts out of the pan, causing burns. Also, when attaching the oil filler cap, always fit a rubber packing, otherwise, when the rubber packing is neglected, the hot oil may spout out of the filler cap fitting, causing burns.

CAUTION

- See “Maintenance 5.1 Use of Lubricating Oil According to Temperature” for which oil to be used.
- Place the machine in travel position for oil quantity inspection. Oil quantity inspection with the machine in working position may deceive your eyes to deem the quantity of oil low. Owing to improper judgment, the oil may be supplied at an excessive amount.
- The engine must be at halt until piping and hydraulic equipment is filled with oil after replacement of the hydraulic oil filter.
- Avoid that oil exceeds the level point (red point) of the level gauge.
When the oil goes beyond the correct level, it may spout out from the air breather, during travelling or crane operation.
- Keep impurities out of the filler cap when replenishing oil.
- Refer to “Operation 1.6 Machinery Cover” and remove the machinery cover in accordance with the instructions in it, when necessary.
- When replacing oil, use a seal tape to the drain cap screw to prevent leakage and then secure the oil cap tightly.

- Oil drain pan: A 30-litre container
- Quantity of oil for replacement: 20 litres

1. Place the machine on a level surface.
2. See “Operation 2.5 Machine Travelling Position” and put the machine in the “travelling position”.
3. Remove the 4 mounting bolts (1) and remove the filler cap (F) on top of the hydraulic oil tank.
4. Place a drain pan directly underneath the drain plug (P) to receive drained oil.
5. Remove the drain plug (P) slowly to drain the oil, keeping from contact with draining oil.
6. Check the drained oil. If check finds a considerable amount of metal powder and foreign objects, contact us or our sales service agency.
7. Put in the drain plug (P) and secure it.

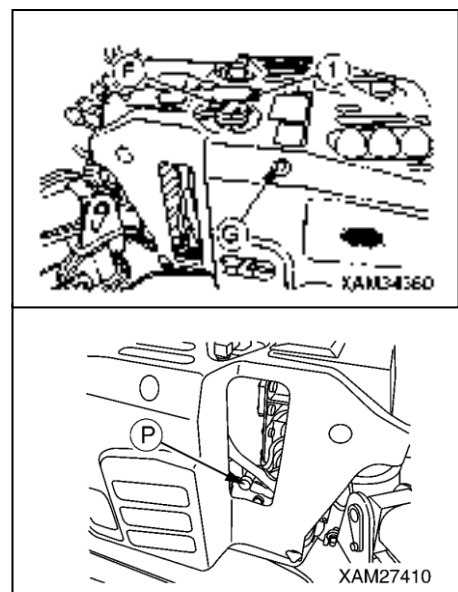

8. Check the oil level gauge (G) and replenish the hydraulic oil until it reaches the level point (red point).

9. After refilling with oil, Set the filler cap (F) and rubber packing to the filler opening position and tighten the 4 mounting bolts (1) securely.

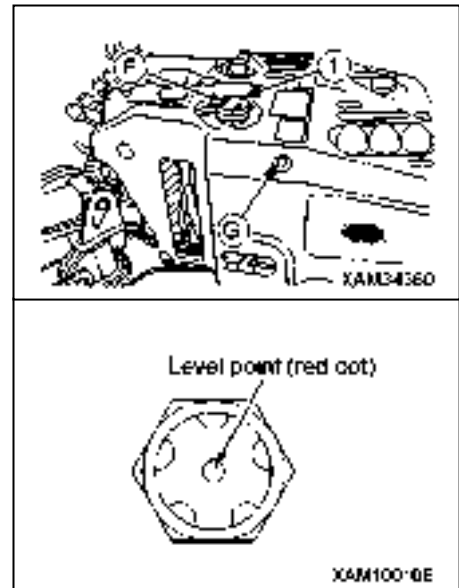

10. Use the following procedure for air bleed.

(1) Start the engine with piping and hydraulic equipment filled with oil.

Make sure the engine runs at low idle for 10 minutes.

(2) Move the cylinders and winch motor slowly with a crane control lever at low idle speed.

Always stop the boom derricking cylinder and telescoping cylinder approx. 100mm back from the stroke end when operating the cylinders.

Repeat this task 4 to 5 times.

(3) Allow all the outriggers to be extended, referring to "Operation 2.13 Outrigger Set Up Operation".

Extend and retract the outrigger cylinder, keeping the machine down on the ground.

Always stop the outrigger cylinder approx. 100mm back from the stroke end when operating the cylinder.

Repeat this task 4 to 5 times.

[2] OIL REPLACEMENT IN SLEWING REDUCTION GEAR CASE

⚠ WARNING

The drain plug of the slewing reduction gear case is located directly underneath the machine. Place the outriggers and raise the machine fully from the ground to allow a drain pan to be placed under the machine for draining oil. If the machine becomes unstable and wobbles, insert supports under the front and back of the machine to gain stability.

CAUTION

- See “Maintenance 5.1 Use of Lubricating Oil According to Temperature” for which oil to be used.
- Use seal tape, etc. at the thread of the filler plug to stop the oil leak and securely tighten the plug after refilling with the oil.

- Oil drain pan: A 1-litre container
- Quantity of oil for replacement: 0.3 litres

1. Place the machine on a level surface.
2. See “Operation 1.6 Machinery Cover” to remove the machinery cover.
3. See “Operation 2.13 Outrigger Set Up Operation” to rotate the rotary of the all outriggers outward.

⚠ WARNING

Check the following before crawling under the machine:

- Ensure that the outriggers are extended at the maximum.
- Visually check the level to make sure the machine is in a horizontal position.
- Insert solid blocks between the crawler and the ground to keep the machine raised.

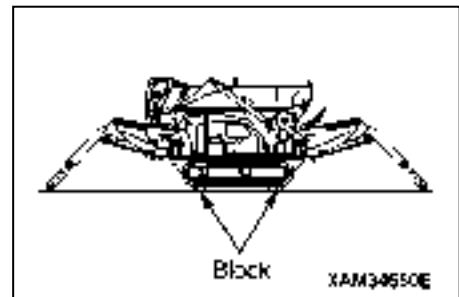

4. Place a drain pan directly underneath the drain plug (P) of the slewing reduction gear case to receive drained oil.
5. Remove the drain plug (P) slowly to drain the oil, keeping from contact with draining oil.
6. Check the drained oil. If check finds a considerable amount of metal powder and foreign objects, contact us or our sales service agency.
7. Put in the drain plug (P) and secure it.
8. Remove 2 mounting bolts (2) and then remove the slewing gear cover (1).

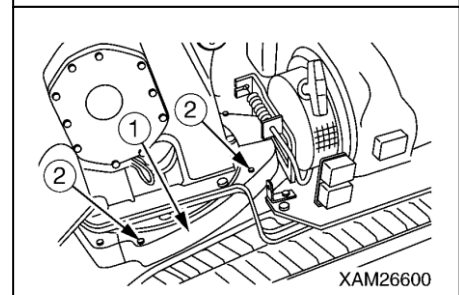
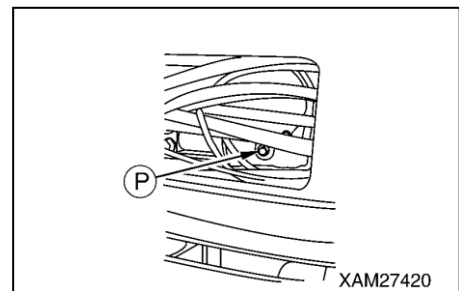

9. Remove the Filler plug (F) of the slewing reduction gear case , and supply the gear oil to the slewing reduction gear case through the filler plug (F) hole.

NOTES

Oil shall be refilled until it almost reaches the plug hole mouth.
--

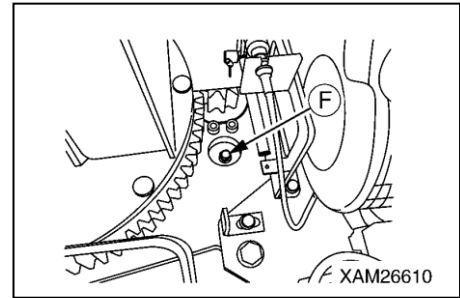

10. Put in the filler plug (F) and secure it after oil replacement.
11. Install the slewing gear cover (1) to the original position and tighten the 2 mounting bolts securely.
12. See “Operation 2.23 Outrigger Stowing Operation” to stow the outriggers.
13. See “Operation 1.6 Machinery Cover” to install the machinery cover.

[3] OIL REPLACEMENT IN WINCH REDUCTION GEAR CASE

⚠ WARNING

- For the winch reduction gear case oil, always use "BONNOC M320 (NIPPON OIL EUROPE LIMITED)".
When any oil other than as specified is used, that may cause deterioration of the winch brake capacity to result in unforeseen accidents.
- Before checking the oil level, allow the machine to cool down to a temperature where you can touch the side near the bottom of the winch reduction gear case. Otherwise hot oil will come out and may cause burns.

CAUTION

- When you can measure "0.8 litre" of the oil specified for the winch reduction gear case using a measuring cup or such, you don't have to remove the oil inspection plug. Just drain the oil from the drain plug and refill the oil from filler plug (F) hole.
- Use seal tape, etc. at the thread of the plug to stop the oil leak and securely tighten the plug after refilling with the oil.

- Oil drain pan: A 1-litre container
 - Quantity of oil for replacement: 0.8 litres
1. Place the machine on a level surface.
 2. Place a drain pan directly under the plug (P) to receive drained oil.
 3. Remove the oil inspection plug (G) and filler plug (F) of the winch reduction case (1).
 4. Remove the drain plug (P) slowly to drain the oil, keeping from contact with draining oil.
 5. Check the drained oil. If check finds a considerable amount of metal powder and foreign objects, contact us or our sales service agency.
 6. Put in the drain plug (P) and secure it.
 7. Supply the gear oil to the winch reduction gear case through the filler plug (F) hole.

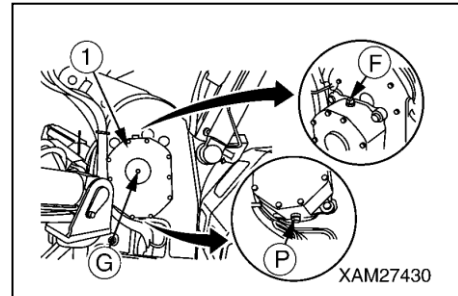

NOTES

- Pour in the gear oil until the oil comes out of the oil level check plug (G).
- If you can measure the amount of the oil, refill the 0.8 litres of the gear oil from filler plug (F) hole.

8. Check that the oil stops flowing out from the oil inspection plug (G) hole, then tighten the oil inspection plug (G) firmly.
9. Put in the filler plug (F) and secure it after oil replacement.
10. After the oil in the winch reduction gear case is replaced, operate the winch lever to wind up and down (with no load and for a stroke about 1.5 metres) for 40 to 50 times so that the new oil spreads all over the gear case.

[4] OIL REPLACEMENT IN TRAVELLING MOTOR REDUCTION GEAR CASE

CAUTION

- See “Maintenance 5.1 Use of Lubricating Oil According to Temperature” for which oil to be used.
- Use seal tape, etc. at the thread of the filler plug to stop the oil leak and securely tighten the plug after refilling with the oil.

- Oil drain pan: A 1-litre container
- Quantity of oil for replacement: 0.33 litres

1. Place the machine on a level surface.
2. Move the machine forward and backward to position it immediately above the drain plug (P) of the travelling motor reduction gear case.
3. Place a drain pan directly under the lower drain plug (P) to receive drained oil.
4. Remove the oil inspection plug (G).
5. Remove the drain plug (P) slowly to drain the oil, keeping from contact with draining oil.
6. Check the drained oil. If check finds a considerable amount of metal powder and foreign objects, contact us or our sales service agency.
7. Put in the drain plug (P) and secure it.
8. Supply the engine oil to the travelling motor reduction gear case through the upper drain plug (G) hole.

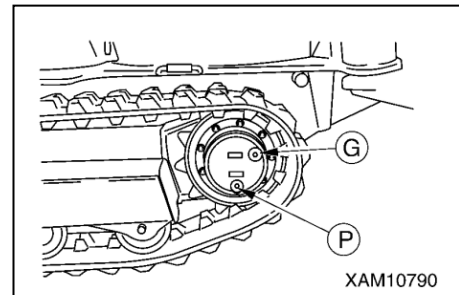

NOTES

Pour in the engine oil until the oil comes out of the oil level check plug (G).

9. Check that the oil stops flowing out from the oil inspection plug (G) hole, then tighten the oil inspection plug (G) firmly.

SPECIFICATIONS

1. SPECIFICATIONS	5-2
2. OVERALL DIMENSIONS	5-4
3. OUTRIGGER SPREAD DIMENSIONS	5-5
4. RATED TOTAL LOAD CHART	5-6
5. WORKING RANGE	5-9

1. SPECIFICATIONS

System / Item		MC-174CRM	
Mass and dimensions	Machine mass	1290kg	
	Overall length × width × height	2000mm x 590mm x 1300mm	
	Distance between idler and sprocket	1044mm	
	Track gauge	410mm	
	Track width	180mm	
Capacity	Maximum rated total load × working radius	1.72t x 1.0m	
	Maximum working radius	5.17m	
	Maximum lifting height	5.5m	
Winch system	Method	Hydraulic piston motor drive, reduction spur gear, mechanical brake	
	Winding speed	10.9m/min (3 layers, 4 falls)	
	Hoisting rope	IWRC 6 x Fi (29) 0/0 φ6 x 35m	
Boom telescoping system	Method	Sequentially telescoping hydraulic cylinder (2 pieces) + Wire rope expansion device (1 piece) (With a hydraulic automatic locking device)	
	Boom type	Pentagonal section, hydraulic automatic extension, 4-stage boom (Stage 3/4: Simultaneous telescoping)	
	Boom length	1.83m – 2.97m – 4.21m – 5.45m	
	Boom telescoping stroke/ time	3.62m/15sec	
Boom derricking system	Method	Direct push-type hydraulic double-acting cylinder (2 pieces), (With a hydraulic automatic locking device)	
	Derrick angle/ time	3 to 77 deg./12sec	
Slewing system	Method	Swing bearing, trochoid motor drive, Reduction gear: Worm + Reduction spur gear, Brake: Worm-selflock	
	Slewing angle/ speed	360 deg. (continuous)/ 2rpm	
Outrigger system	Method	1st stage with flexible stay damper, 2nd stage manual pull-out, hydraulic cylinder direct acting	
	Overall width of extended outriggers	(Front) 3060mm x (Right/left) 3335mm x (Rear) 2885mm	
Traveling system	Method	Hydraulic two-speed motor drive, Variable speed, Built-in brake	
	Travel speed	High speed	Forward/backward: 0 – 3.3km/h
		Low speed	Forward/backward: 0 – 2.0km/h
	Gradeability	20 deg.	
Ground pressure	33.7kPa (0.34kgf/cm ²)		
Hydraulic system	Hydraulic pump	Double-throw variable piston pump (8.6cc/rev × 2)	
	Rated pressure	20.6MPa (210kgf/cm ²)	
	Hydraulic oil tank capacity	20 litres	

System / Item		MC-174C
Engine	Model	Mitsubishi GM401LE
	Type	1-cylinder, Air cooled, 4-cycle gasoline engine
	Displacement	0.391 litres (391cc)
	Rated output (continuous)	6.6kW/1800min ⁻¹ (9.0PS/1800rpm)
	Fuel tank capacity	Lead-free gasoline/6 litres
Battery	Model	30A19R (DC12V x 1 piece)
Safety device	Over hoist detector/automatic stop device, hydraulic safety valve, hydraulic automatic locking device, slinging rope detachment protector, alarm buzzer, level, crane inclination alarm (travel mode : more than 15 degree, crane & outrigger mode : more than 3 degree), moment limiter (working envelope limited), working status lamp, over un-winding detector	

2. OVERALL DIMENSIONS

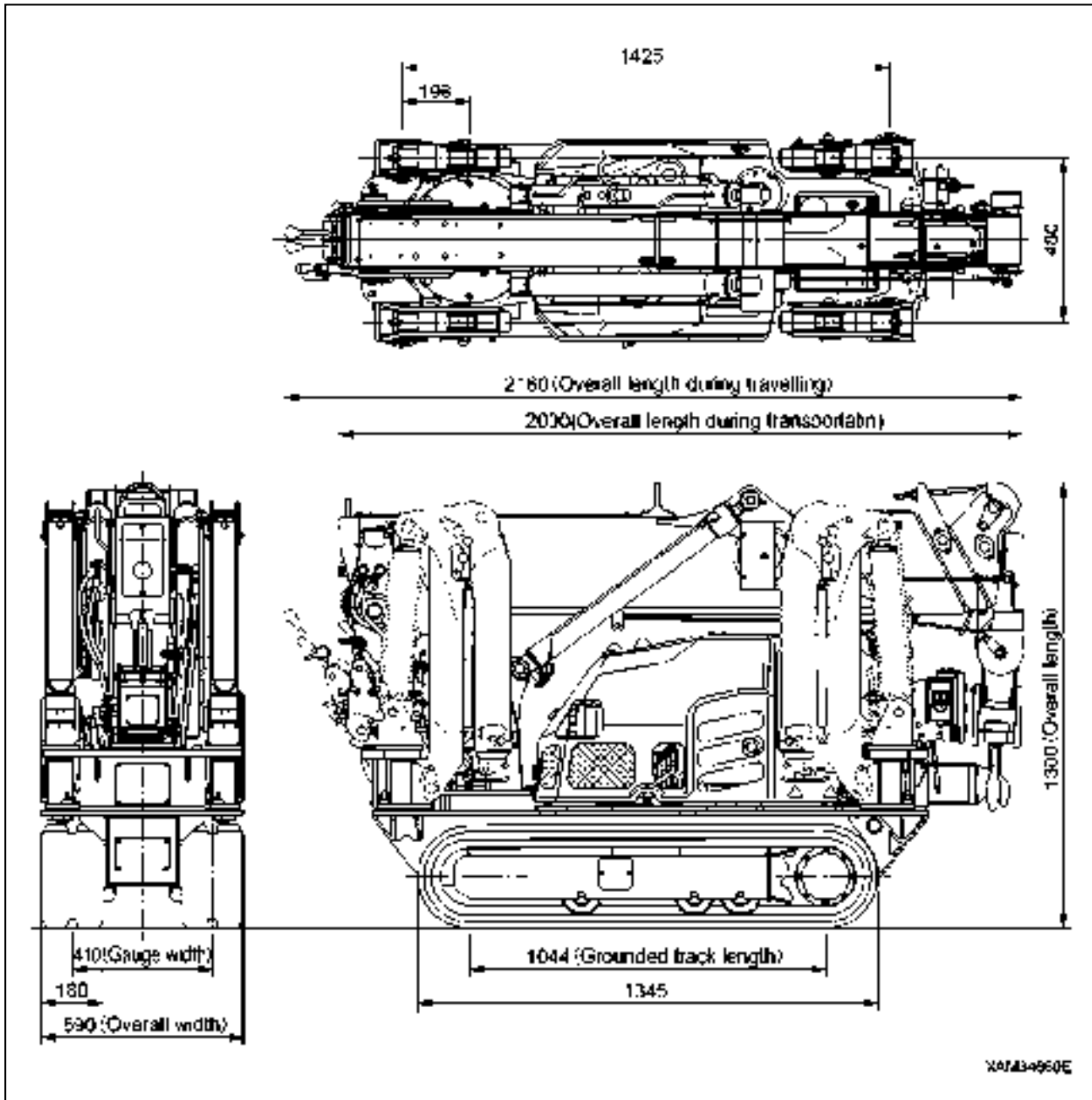

3. OUTRIGGER SPREAD DIMENSIONS

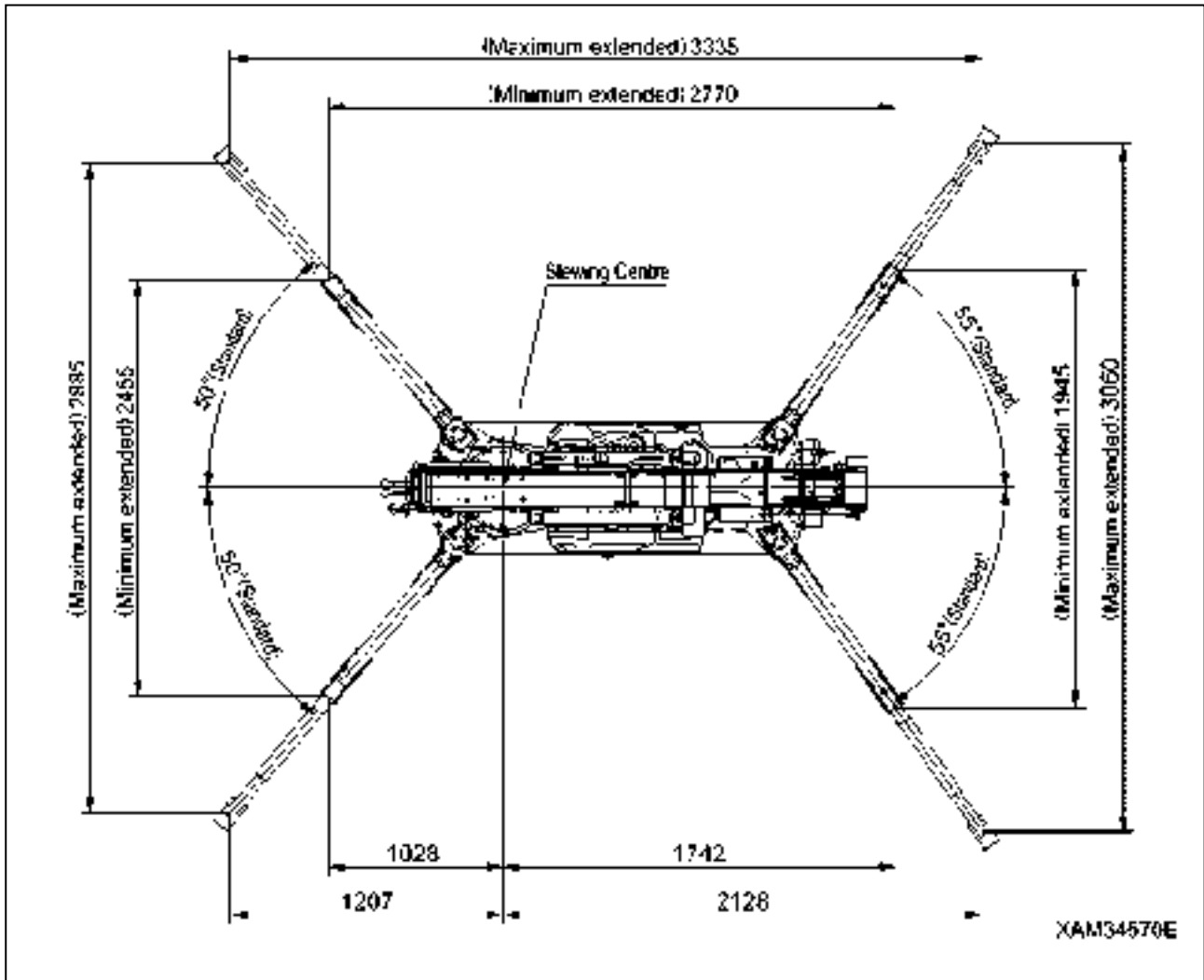

4. RATED TOTAL LOAD CHART

★The Rated Total Load Chart is based on actual working radius with the bending of boom attributable to load reflected and is shown with the mass of hook block (20kg) included.

4.1 RATED TOTAL LOAD CHART FOR 4 FALLS

OUTRIGGER EXTENDED TO MAXIMUM							
1.83m BOOM		2.97m BOOM		4.21m BOOM		5.45m BOOM	
Working radius (m)	Total rated load (kg)	Working radius (m)	Total rated load (kg)	Working radius (m)	Total rated load (kg)	Working radius (m)	Total rated load (kg)
1.0 or less	1720	1.0 or less	1720	1.3 or less	1320	1.7 or less	770
1.3	1320	1.3	1320	1.5	1120	2.0	700
1.55	1090	1.5	1120	2.0	820	2.5	660
--	--	2.0	820	2.5	670	2.8	580
--	--	2.5	670	3.0	530	3.0	530
--	--	2.69	580	3.5	420	3.5	410
--	--	--	--	3.93	370	4.0	330
--	--	--	--	--	--	4.5	270
--	--	--	--	--	--	5.17	220

OUTRIGGER EXTENDED TO OTHER THAN MAXIMUM							
1.83m BOOM		2.97m BOOM		4.21m BOOM		5.45m BOOM	
Working radius (m)	Total rated load (kg)	Working radius (m)	Total rated load (kg)	Working radius (m)	Total rated load (kg)	Working radius (m)	Total rated load (kg)
1.0 or less	1220	1.0 or less	1220	1.3 or less	940	1.7 or less	720
1.3	940	1.3	940	1.5	810	2.0	600
1.55	790	1.5	810	2.0	600	2.5	390
--	--	2.0	600	2.5	390	2.8	330
--	--	2.5	390	3.0	300	3.0	300
--	--	2.69	310	3.5	220	3.5	220
--	--	--	--	3.93	180	4.0	180
--	--	--	--	--	--	4.5	140
--	--	--	--	--	--	5.17	100

4.2 RATED TOTAL LOAD CHART FOR 2 FALLS

OUTRIGGER EXTENDED TO MAXIMUM							
1.83m BOOM		2.97m BOOM		4.21m BOOM		5.45m BOOM	
Working radius (m)	Total rated load (kg)	Working radius (m)	Total rated load (kg)	Working radius (m)	Total rated load (kg)	Working radius (m)	Total rated load (kg)
1.0 or less	860	1.0 or less	860	1.3 or less	860	1.7 or less	770
1.3	860	1.3	860	1.5	860	2.0	700
1.55	860	1.5	860	2.0	820	2.5	660
--	--	2.0	820	2.5	670	2.8	580
--	--	2.5	670	3.0	530	3.0	530
--	--	2.69	580	3.5	420	3.5	410
--	--	--	--	3.93	370	4.0	330
--	--	--	--	--	--	4.5	270
--	--	--	--	--	--	5.17	220

OUTRIGGER EXTENDED TO OTHER THAN MAXIMUM							
1.83m BOOM		2.97m BOOM		4.21m BOOM		5.45m BOOM	
Working radius (m)	Total rated load (kg)	Working radius (m)	Total rated load (kg)	Working radius (m)	Total rated load (kg)	Working radius (m)	Total rated load (kg)
1.0 or less	860	1.0 or less	860	1.3 or less	860	1.7 or less	720
1.3	860	1.3	860	1.5	810	2.0	600
1.55	790	1.5	810	2.0	600	2.5	390
--	--	2.0	600	2.5	390	2.8	330
--	--	2.5	390	3.0	300	3.0	300
--	--	2.69	310	3.5	220	3.5	220
--	--	--	--	3.93	180	4.0	180
--	--	--	--	--	--	4.5	140
--	--	--	--	--	--	5.17	100

Hook block : 20 kg

4.3 RATED TOTAL LOAD CHART FOR SINGLE FALL

OUTRIGGER EXTENDED TO MAXIMUM							
1.83m BOOM		2.97m BOOM		4.21m BOOM		5.45m BOOM	
Working radius (m)	Total rated load (kg)	Working radius (m)	Total rated load (kg)	Working radius (m)	Total rated load (kg)	Working radius (m)	Total rated load (kg)
1.0 or less	430	1.0 or less	430	1.3 or less	430	1.7 or less	430
1.3	430	1.3	430	1.5	430	2.0	430
1.55	430	1.5	430	2.0	430	2.5	430
--	--	2.0	430	2.5	430	2.8	430
--	--	2.5	430	3.0	430	3.0	430
--	--	2.69	430	3.5	420	3.5	410
--	--	--	--	3.93	370	4.0	330
--	--	--	--	--	--	4.5	270
--	--	--	--	--	--	5.17	220

OUTRIGGER EXTENDED TO OTHER THAN MAXIMUM							
1.83m BOOM		2.97m BOOM		4.21m BOOM		5.45m BOOM	
Working radius (m)	Total rated load (kg)	Working radius (m)	Total rated load (kg)	Working radius (m)	Total rated load (kg)	Working radius (m)	Total rated load (kg)
1.0 or less	430	1.0 or less	430	1.3 or less	430	1.7 or less	430
1.3	430	1.3	430	1.5	430	2.0	430
1.55	430	1.5	430	2.0	430	2.5	390
--	--	2.0	430	2.5	390	2.8	330
--	--	2.5	390	3.0	300	3.0	300
--	--	2.69	310	3.5	220	3.5	220
--	--	--	--	3.93	180	4.0	180
--	--	--	--	--	--	4.5	140
--	--	--	--	--	--	5.17	100

Hook block : 10 kg

5. WORKING RANGE

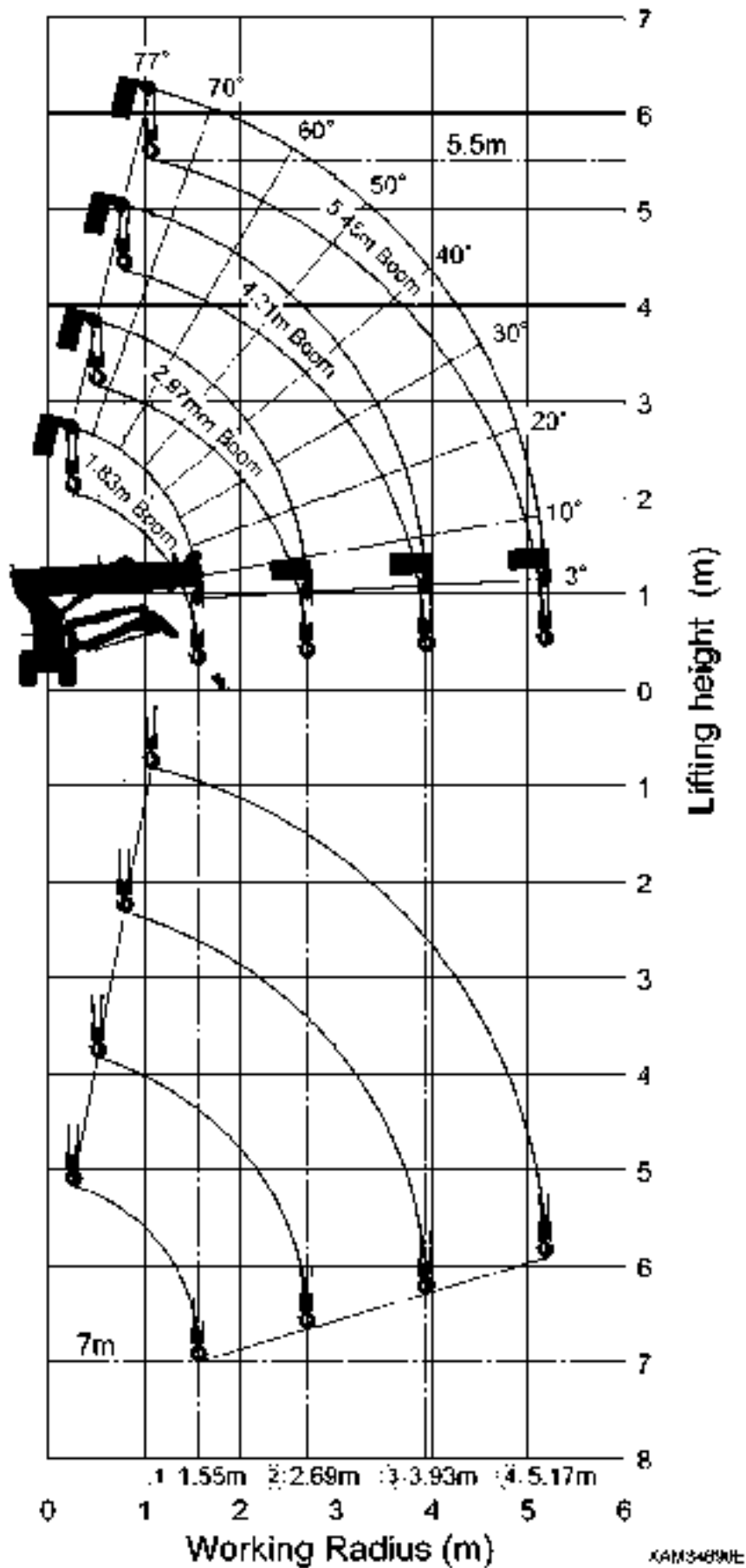

REMOTE CONTROL

1. OUTLINE OF REMOTE CONTROLLER	6- 2
2. SAFETY PRECAUTIONS	6- 4
3. LOCATIONS OF SAFETY LABELS	6- 8
4. COMPONENTS OF THE TRANSMITTER	6-10
5. COMPONENTS OF THE RECEIVER	6-15
6. SETTING UP OPERATION MODES OF TRANSMITTER	6-18
7. CHECKING BEFORE OPERATION	6-26
8. OPERATION	6-38
9. TROUBLE SHOOTING	6-52
10.SYSTEM SPECIFICATIONS	6-55

1. OUTLINE OF REMOTE CONTROLLER

1.1 FEATURE

This system is designed principally for the following purposes:

This Remote Controller includes both Transmitter and Receiver which facilitate remote control of the Crane which is purchased with this device.

This Remote Controller provides operation of the Crane at the most convenient place away from it within a range of the length of the connection cable.

1.2 CONFIGURATION

The configuration of this system is as below:

[1] TRANSMITTER

The Transmitter is equipped with LCD screen (1), Six control buttons (2), Four operation levers (3), Accelerator lever (4), Grip (5) and Cable connection (6).

The Transmitter sends signals for crane operations to the Receiver through the connection cable so that remote operation of the Crane can be carried out.

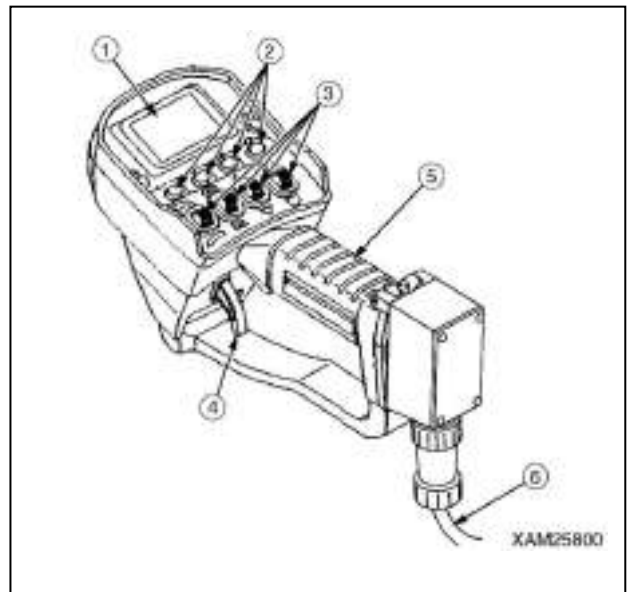

[2] RECEIVER

The Receiver which is installed in the Crane is equipped with Control box (1), Main switch (2), Monitor display (3), and Cable connector (4), etc.

The Receiver receives operation signals from the Transmitter through the connection cable which controls the Crane.

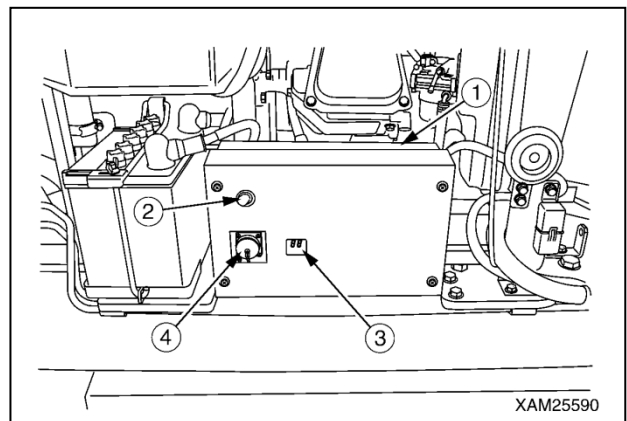



1.3 FUNCTIONS OF REMOTE CONTROL SYSTEM

- The Transmitter allows one hand operation, which enables craning works, such as holding the load by the other hand or slinging, by one person.
- The Accelerator lever facilitates the control of the Crane operation speed from stand-by condition to the maximum speed.
- The LCD screen of the Transmitter indicates operation status, such as “Crane operating”, “Speed control”, “Outrigger setting” and so on, to provide easy confirmation.
In addition, the LCD screen of the Transmitter shows error messages in the event where the Transmitter has a failure, so that the detection and correction of the failure is promptly accomplished.
Still more, the voice messages will notify the Transmitter conditions or warning alerts.
- Dependant on the operation requirement, manual operation on the console of the Crane is also available, in addition to handling by the remote control Transmitter.
- The connection via the cable between the Transmitter and Receiver allows secure communication between both.

2. SAFETY PRECAUTIONS

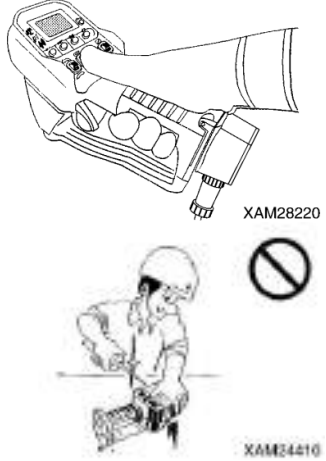
2.1 FOR SAFETY OPERATIONS

NO MODIFICATION !	
<ul style="list-style-type: none">• Do not attempt to modify or disassemble the Transmitter and Receiver, or the accessories, which may cause an electrical shock or a fire.	
HOLDING THE TRANSMITTER	
<ul style="list-style-type: none">• The Transmitter is designed for one hand controls in general. Refer to the figure in the right for basic usage of the Transmitter. Levers and buttons can be manipulated by the thumb, while the Accelerator lever can be triggered by the forefinger. Other fingers should grab the grip to hold the Transmitter.• Always manipulate levers and switches by fingers. Do not attempt to operate it by any other method such as a screwdriver etc. It may make a hole in the Transmitter which allows water to enter inside the body causing problems or failures which could cause a serious hazard.	
NO WATER WASHING	
<ul style="list-style-type: none">• Always keep the Transmitter unsoiled, and clean it when necessary. Oil or mud on surface may cause miss-operation with slipping hands, which may result a serious hazard.• Do not attempt to wash the transmitter with water, in any event. It allows water to enter inside and causes problems or failures and could cause a serious hazard.• Scrub the Transmitter and Receiver with a damp water cloth or diluted detergent to remove the dirt. Avoid alkaline or alcoholic cleaners or sprayer cleaners which deteriorate plastics and produce cracks.	

NO SHOCK TO THE TRANSMITTER

- During the Transmitter operations, always use a hook belt (1) to prevent unexpected dropping of the unit.
- Always avoid an impact to the Transmitter, such as hitting it on any object.
It may result in damage to the enclosure or internal components which may cause a failure or malfunction including electrical shock or other serious hazard.
- In the event of such damages, call us or to our agents for service.
Use of a damaged Transmitter will result in miss-operation and cause an electrical shock or other serious hazard.

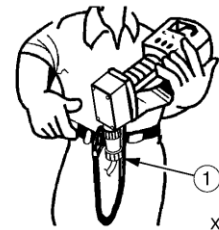

XAM28230



XAM24440

PRECAUTION FOR OPERATIONS IN COLD SEASONS

- Avoid the use of the Transmitter in a condition where the ambient temperature makes a sudden change or becomes extremely low (-10°C or below) or cold air is blowing
Sudden change in temperature may cause dew formation inside the Transmitter and can causes failure or malfunction and leads to a serious hazard.
- In the winter times, allow sufficient idling prior to starting crane operations. In the winter, due to the low temperature, hydraulic fluid has higher viscosity. Such condition may result in a delay of functions in crane operations.
- Keep the Transmitter away from conditions shown below when storing, where the Transmitter enclosure may deform or discolor, or internal components may be damaged causing malfunctions and a serious hazard:
 - Extremely low temperature (-20°C or below) or in direct cold air.
 - Direct sun light.
 - Adjacent to warm air outlets of vehicles.
 - Adjacent to housing heating system.
 - High humidity.



XAM28240

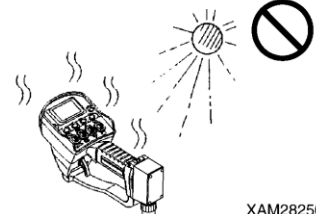

XAM28250

PRECAUTIONS FOR HANDLING OF CONNECTION CABLE

Do not attempt to hang the Transmitter by the connection cable and fling it around, or bend the cable or thread on it. Such poor handling will damage the internal wires or produce other failures.

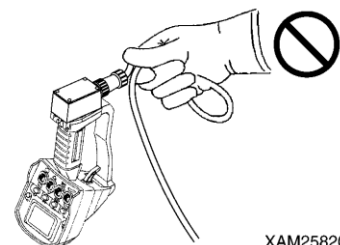

XAM25820

2.2 PRECAUTIONS FOR CRANE OPERATION

WARNING

As to matters to be taken care of during operation, refer to the section of “SAFETY”, in addition to the following clauses.

2.2.1 PRIOR TO STARTING ENGINE

INSPECTION PRIOR TO STARTING ENGINE

At the start of the day's operation, perform the opening inspection as specified for this machine, prior to starting the engine.

Serious injury or death may arise when these inspections are neglected.

Any failure detected at the inspection must be properly corrected.

SAFETY MEASURES FOR STARTING ENGINE

- Ensure that nobody is around the Crane, or no obstacles, prior to starting the engine.
- Sound the horn to be noticed just before turning the ignition key.
- Never attempt to short circuit the starter for the purpose of starting the engine, it may cause fire.

INSPECTION PRIOR TO TURN ON THE TRANSMITTER

- Check for any dirt, damage or cracks in the enclosure, control levers, operation buttons, or LCD screen.
- Ensure that the Transmitter's control levers, operation buttons and the Accelerator lever move smoothly and properly.
- Check the connection cable for damage or crack when the Remote Control Transmitter is in use.

INSPECTION FOLLOWING TURN ON THE TRANSMITTER

Ensure that LCD screen of the Transmitter provides correct indications.

- Switch to each operation mode, i.e. CRANE MODE and OUTRIGGER MODE, then check that LCD screen displays proper indications when each lever and button is manipulated. Further, verify that each applicable value of load in the Transmitter is identical to that of the Moment limiter display.

INSPECTION PRIOR TO TURNING ON THE RECEIVER

- Check for any dirt, damage or cracks in the Receiver's Control box, Main switch and Monitor display etc.
- Ensure that the Receiver's Main switch moves smoothly and properly.

2.2.2 SUBSEQUENT TO STARTING ENGINE

FUNCTION CHECK OF OUTRIGGER MODE BY THE TRANSMITTER, AND NOTICES FOR OPERATION

- Switch the operation mode to the “OUTRIGGER MODE” and confirm that the mode is switched correctly.
- Activate “Start/Reset button” to assure that the engine correctly starts.
- Activate “Stop/EMO button to assure the engine correctly stops.
- Operate the outrigger control switches to assure that the corresponding outrigger works correctly.
- Check that the position pins for outriggers and retainers are securely fixed.

FUNCTION CHECK OF CRANE MODE BY THE TRANSMITTER AND NOTICES FOR OPERATION

- Before switching the operation mode to “CRANE MODE” always make all the outriggers extended and securely contacted on the ground.
- Switch the operation mode to the “CRANE MODE” and confirm that the mode is switched correctly.
- Activate levers for crane operations and assure that the Crane functions correctly.
- Always refer to the portable rated total load chart and avoid over-loaded operations.
- Activate the control levers and Accelerator lever of the Transmitter slowly at all times.

2.2.3 TERMINATING THE OPERATION

PRECAUTIONS FOR TERMINATING THE OPERATION BY THE TRANSMITTER

- Before stowing the boom, switch the operation mode to “CRANE MODE” and confirm that the mode is switched correctly.
- Before stowing the outriggers, ensure that the boom and the hook is stowed in the correct positions.
- Before stowing the outriggers, switch the operation mode to “OUTRIGGER MODE” and confirm that the mode is switched correctly.
- When all the operation of the Transmitter is complete, always turn OFF the power of both the Transmitter and Receiver.
- Under no condition will the Transmitter be ON unless the Crane is in operation, otherwise, unexpected touching or contact of operation levers or buttons of the Transmitter by any other object, may cause un-desired motion of the Crane and a serious accident such as tipping or collision may occur.
- Where it is required to turn ON the Transmitter for the purpose of inspecting it or such, always keep the Receiver OFF and stop the engine, as well.

3. LOCATIONS OF SAFETY LABELS

Always keep these labels dirt free.

When labels come off, stick them on again or replace with new ones.

In addition to safety labels shown below, several other labels are requisite. Treat them in the same manner.

Transmitter

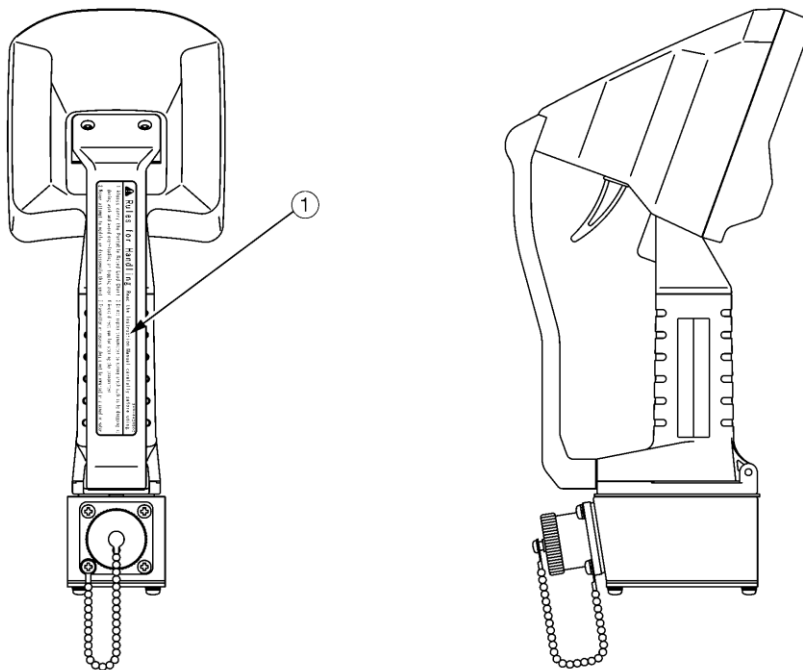

XAM28260

Receiver

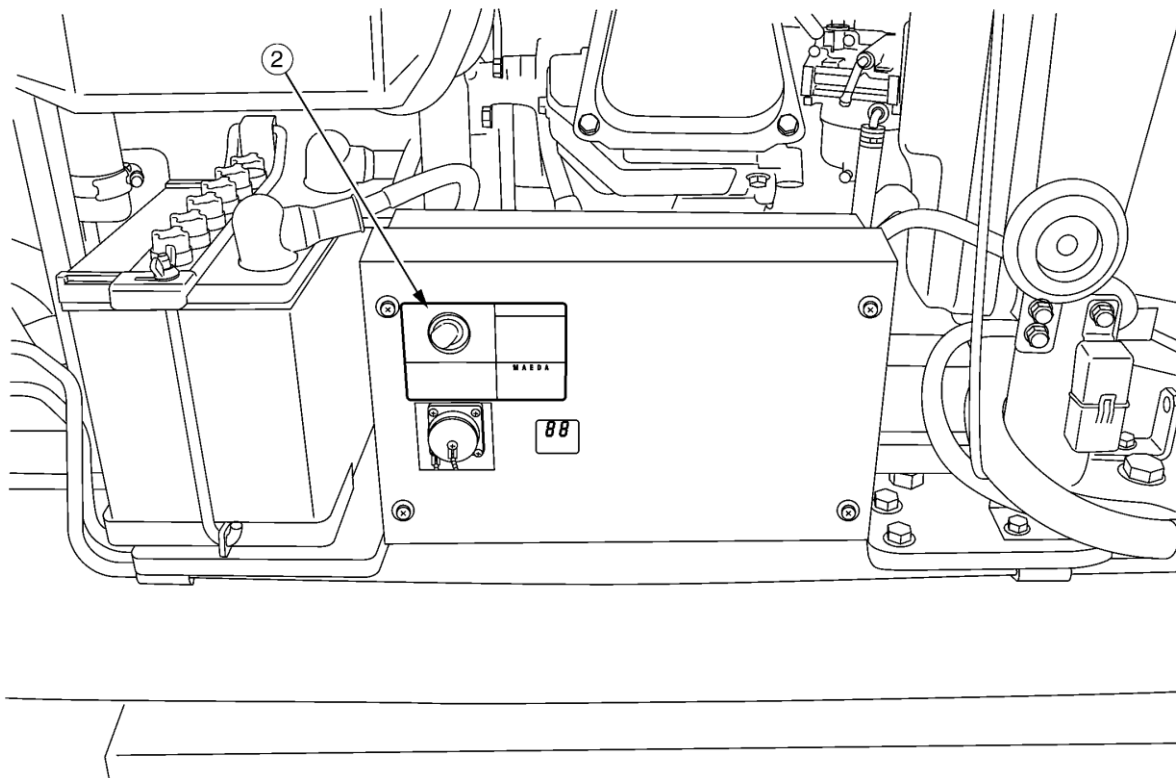

XAM25760

(1) Precautions for remote control (Transmitter) (349-4428500)

349-4428500	
⚠ Rules for Handling Read the Instruction Manual carefully before using.	
1. Always carry the Portable Rated Load Chart	3. Do not expose transmitter to strong shock such as by dropping it during work and avoid over-loading or tipping over.
2. Never attempt to modify or disassemble this unit.	4. Avoid direct sun for storing the transmitter.
5. Transmitter or receiver should not be immersed or cleaned in water.	

(2) Caution for remote-control receiver (101-4593000)

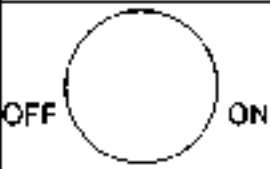
MAIN SWITCH	⚠ CAUTION
	<ul style="list-style-type: none"> • Be sure to read the instruction manual. • Modification or disassembly strictly prohibited. • Have the power supply turned off whenever remote control is not in use. • Direct washing prohibited. • Cover the receptacle with water-tight cap provided whenever remote control is not in use.
RECEPTACLE	M A E B A REMOTE CONTROL model MCT300N 101-4593000

4. COMPONENTS OF THE TRANSMITTER

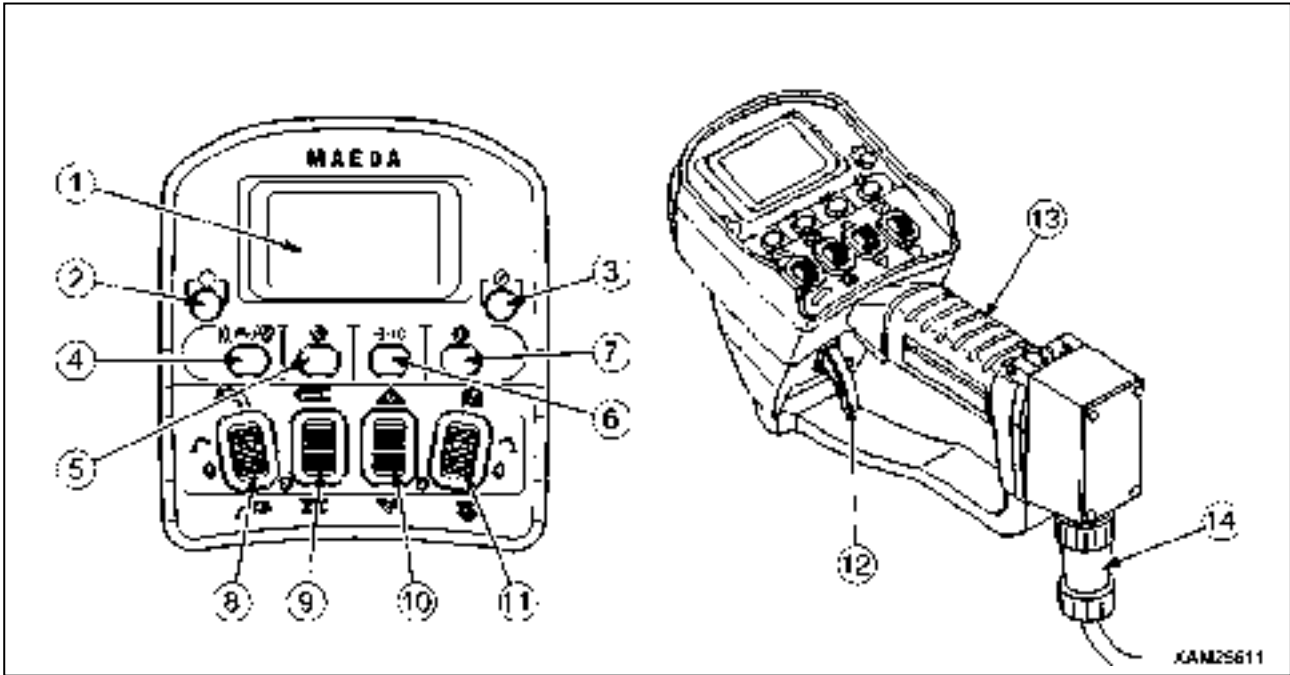

- | | |
|------------------------|---|
| (1) LCD Screen | (8) Slewing/No.1 Outrigger Operation Lever |
| (2) Start/Reset Button | (9) Boom Telescoping/No.2 Outrigger Operation Lever |
| (3) Stop/EMO Button | (10) Hook Raising and Lowering/No.3 Outrigger Operation Lever |
| (4) Speed/Mode Button | (11) Boom derricking/No.4 Outrigger Operation Lever |
| (5) Setting Button | (12) Accelerator Lever |
| (6) Horn Button | (13) Grip |
| (7) Power Switch | (14) Connection Cable |

CAUTION

The remote control system provides the following safety functions:

- **Abnormal Signal Detector Circuit**

When the Main switch of the Receiver is turned ON this circuit checks the dispatch of Crane operation signals for 3 to 4 seconds. Thus, the Crane will not be immediately ready for operations.

When dispatch of any crane operation signals are noticed, power will be automatically OFF and the Crane stops.

To resume, push the Reset button of the Transmitter.

- **Automatic Power OFF Circuit**

Power of the Transmitter will be automatically OFF when the remote control of crane operations is discontinued for the specific time.

To resume, push the Power switch of the Transmitter to ON.

- **Voltage Drop Limiter (for the Receiver)**

The Receiver will automatically shut down in the event whereby the voltage of the battery drops below DC 9 volts.

This prevents malfunctions of the Crane due to voltage drop and the operation will resume automatically when the voltage is restored to DC 9 volts or higher.

[1] LCD SCREEN (1)

The LCD screen displays the status of the Transmitter in operation, the established values for each mode, or error messages by symbols, comments or signs.

[2] START/RESET BUTTON (2)

This button has two usages as below:

- To push this button starts the engine.
- This button resets the “Emergency Stop” and “Abnormal Signal Detect” conditions.

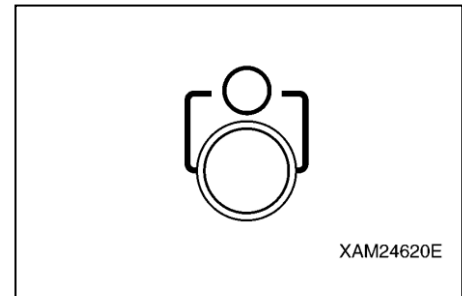

[3] STOP/EMO BUTTON (3)

This button also has two usages as below:

- To push this button stops the engine.
- In an emergency event where the Crane does not stop by normal operations, or such, this button provides the forced stop function.

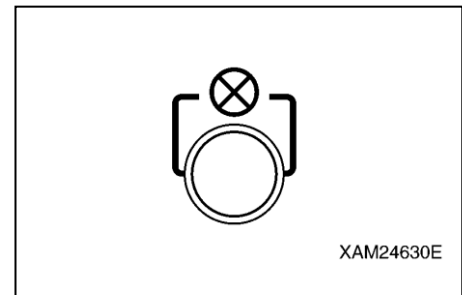

[4] SPEED/MODE BUTTON (4)

This button also provides two usages as below:

- During crane operations, to push this button decelerates the operation speed.
- Whilst the crane operation is paused, this button provides the selection of the Transmitter operation modes. The current active mode will be displayed in the LCD screen.

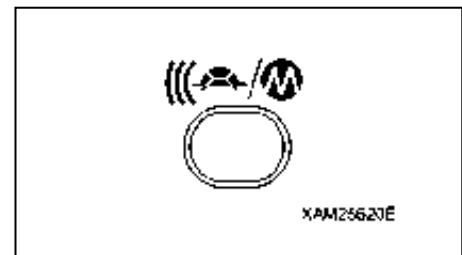

[5] SETTING BUTTON (5)

- For each of the setting of the modes, use this button to select one of the choice from the menu in the LCD screen.

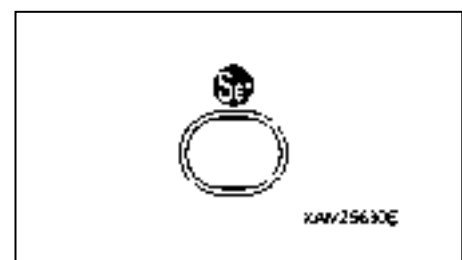

[6] HORN BUTTON (6)

Push this button to toot the horn.

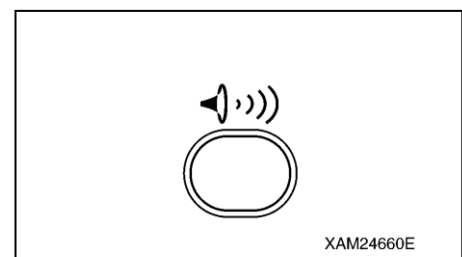

[7] POWER SWITCH (7)

To push this button switches ON and OFF the power of the Transmitter. Each push will turn ON or OFF alternately.

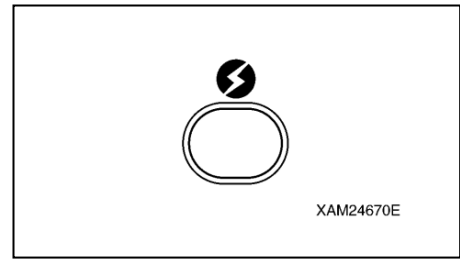

[8] SLEWING/No.1 OUTRIGGER OPERATION LEVER (8)

This operation lever functions in two ways as below:

1. In the CRANE MODE, this lever controls slew of the Crane structure:
 - Counterclockwise: Push the upper end of the lever.
 - Neutral: Release your finger from the lever.
 - Clockwise: Push the lower end of the lever.
2. In the OUTRIGGER MODE, this lever controls extension (setting) and retraction (stowing) of either only No.1 or all of the outriggers at once:
 - Retraction (stowing): Push the upper end of the lever.
 - Neutral: Release your finger from the lever.
 - Extension (setting): Push the lower end of the lever.

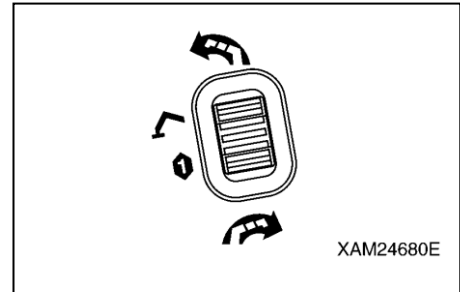

[9] BOOM TELESCOPING/No.2 OUTRIGGER OPERATION LEVER (9)

This operation lever functions in two ways as below:

1. In the CRANE MODE, this lever controls the telescopic boom length:
 - Boom extension: Push the upper end of the lever.
 - Neutral: Release your finger from the lever.
 - Boom retraction: Push the lower end of the lever.
2. In the OUTRIGGER MODE, this lever controls extension (setting) and retraction (stowing) of either only No.2 or all of the outriggers at once:
 - Retraction (stowing): Push the upper end of the lever.
 - Neutral: Release your finger from the lever.
 - Extension (setting): Push the lower end of the lever.

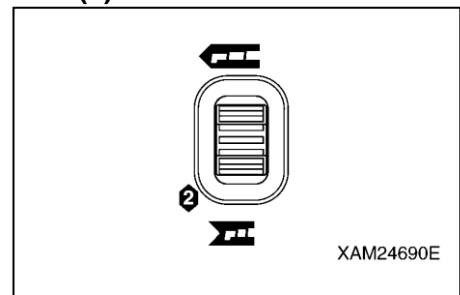

[10] HOOK RAISING AND LOWERING/No.3 OUTRIGGER OPERATION LEVER (10)

This operation lever functions in three ways as below:

1. In the CRANE MODE, this lever controls raising and lowering the hook:
 - Hook raising: Push the upper end of the lever.
 - Neutral: Release your finger from the lever.
 - Hook Lowering: Push the lower end of the lever.
2. In the OUTRIGGER MODE, this lever controls extension (setting) and retraction (stowing) of either only No.3 or all of the outriggers at once:
 - Retraction (Stowing): Push the upper end of the lever.
 - Neutral: Release your finger from the lever.
 - Extension (setting): Push the lower end of the lever.
3. In the A MODE and OPERATION MODE, this lever is used as a cursor key by “▲ and ▼”.

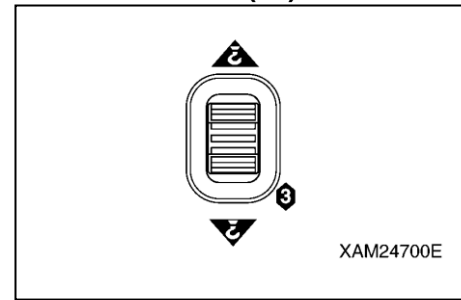

[11] BOOM DERRICKING/No.4 OUTRIGGER OPERATION LEVER (11)

This operation lever functions in two ways as below:

1. In the CRANE MODE, this lever controls the boom derricking angle:
 - Boom raising: Push the upper end of the lever.
 - Neutral: Release your finger from the lever.
 - Boom lowering: Push the lower end of the lever.
2. In the OUTRIGGER MODE, this lever controls extension (setting) and retraction (stowing) of either only No.4 or all of the outriggers at once:
 - Retraction (stowing): Push the upper end of the lever.
 - Neutral: Release your finger from the lever.
 - Extension (setting): Push the lower end of the lever.

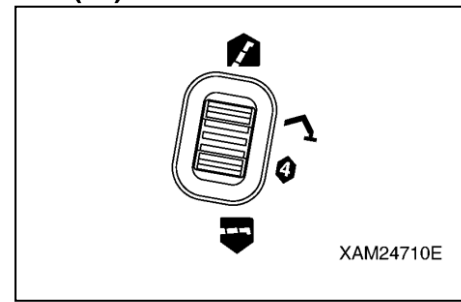

[12] ACCELERATOR LEVER (12)

The Accelerator lever controls the flow rate of the control valves and the engine speed or output.

- Low idling: Release your finger from the Accelerator lever.
- Full throttle: Squeeze the accelerator lever to the full.

NOTES

- The Accelerator lever itself cannot control either flow rate of the control valves or the engine speed when it is manipulated alone.

When used in conjunction with any of the other operation levers, the Accelerator lever launches the specified operation of the Crane in the idling state of the engine, then when it is manipulated further the engine speeds up. This is progressive until the full throttle position is reached.

- The Accelerator lever does not control outriggers.
- The acceleration rate is always indicated in the right part of the LCD screen during crane operations. (See the figure in the right.)

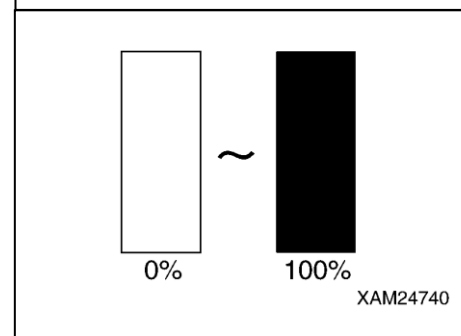
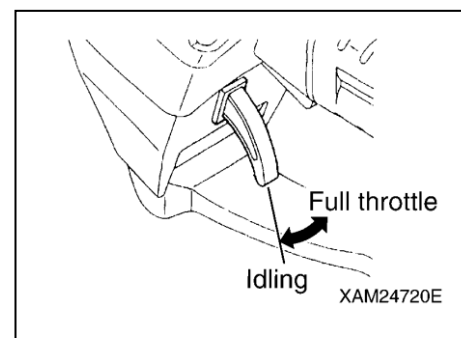

[13] GRIP (13)

The Transmitter is designed for one hand control in general. Levers and buttons can be manipulated by your thumb, while the accelerator lever can be triggered by your forefinger. Other fingers should grab the grip to hold the Transmitter.

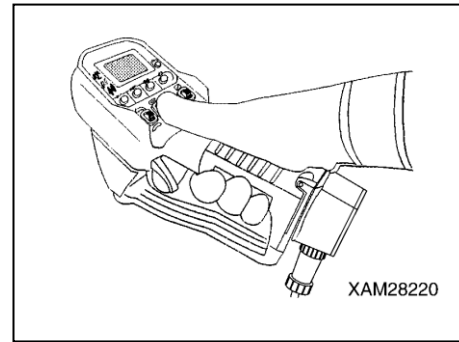

[14] CONNECTION CABLE (14)

The connection cable is a cable between the Transmitter and Receiver.

Before and after the operation, always check this connection cable for any cracks, damage, or bending. Also check the receptacle for any damage.

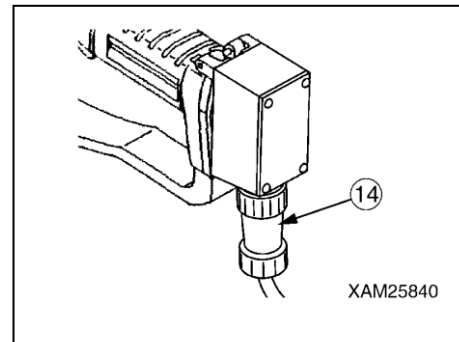

[15] STORAGE CASE (15)

The Storage case is a compact bag for protection of the Transmitter.

Before putting it into this case, ensure that the power of the Transmitter is OFF.

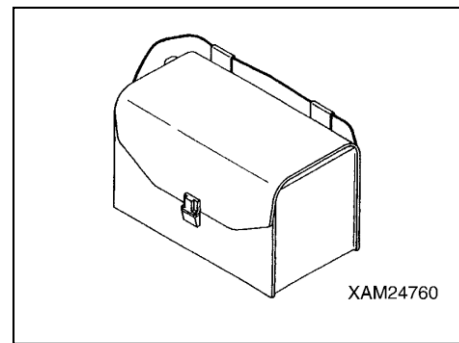

[16] HOOK BELT (16)

During the operation, this belt prevents the Transmitter from falling down to the ground, when the operator drops it by mistake.

Hook one end of the hook belt (16) to the Transmitter and attach another end to the operator's waist belt etc.

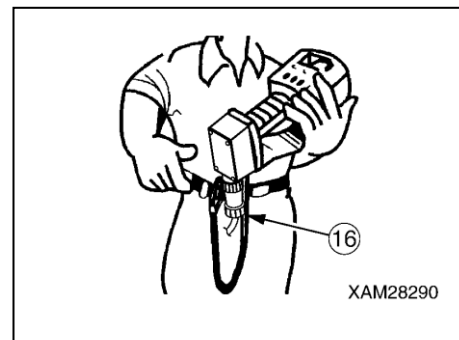

5. COMPONENTS OF THE RECEIVER

5.1 COMPONENTS OF THE RECEIVER

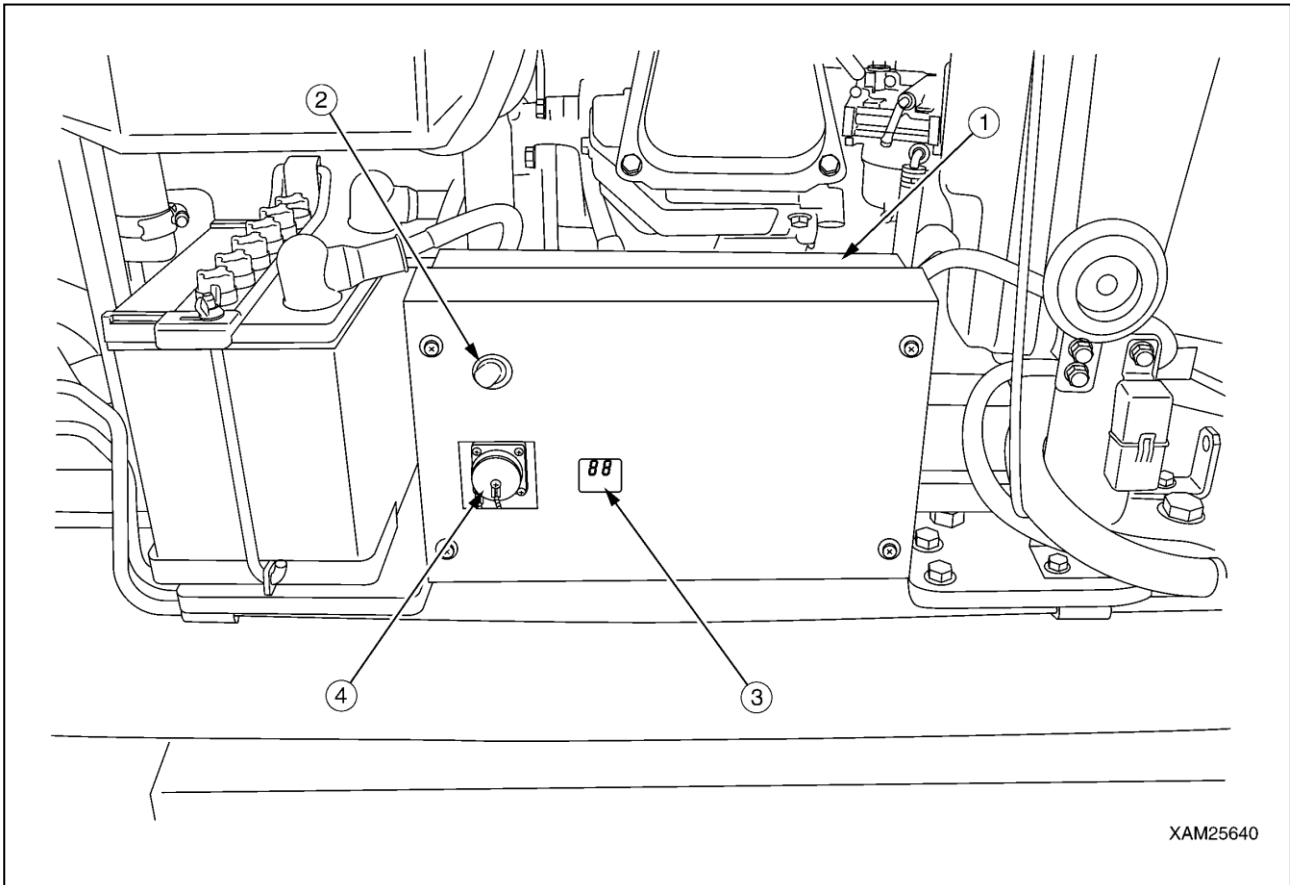

- (1) Control Box
- (2) Main Switch

- (3) Monitor Display
- (4) Cable Connector

CAUTION

The remote control system provides the following safety functions:

- **Abnormal Signal Detector Circuit**

When the Main switch of the Receiver is turned ON, this circuit checks the dispatch of crane operations signals for 3 to 4 seconds. Thus, the Crane will not be immediately ready for operations.

When dispatch of any crane operation signals are noticed, power will be automatically turn OFF and the Crane stops. To resume, push the Reset button of the Transmitter.

- **Automatic Power OFF circuit**

Power of the Transmitter will be automatically OFF when the remote control of the crane operation is discontinued for a specific time.

To resume, push the Power switch of the Transmitter to ON.

- **Voltage Drop Limiter (for the Receiver)**

The Receiver will automatically shut down in the event whereby the voltage of the battery drops below DC 9 volts.

This prevents malfunctions of the Crane due to voltage drop and the operation will resume automatically when the voltage is restored to DC 9 volts or higher.

[1] CONTROL BOX (1)

The Control box contains the receiver devices and control devices.
Never attempt to dismantle this Control box.

[2] MAIN SWITCH (2)

The Main switch is a toggle switch to power ON or OFF the Receiver

- ON : Turn the toggle to ON to start the Receiver.
- OFF: Turn the toggle to OFF to terminate the Receiver.

CAUTION

- Before starting the engine, always turn this Main switch of the Receiver to OFF.
- Where the remote control is not in use, always turn the main switch of the Receiver to OFF.

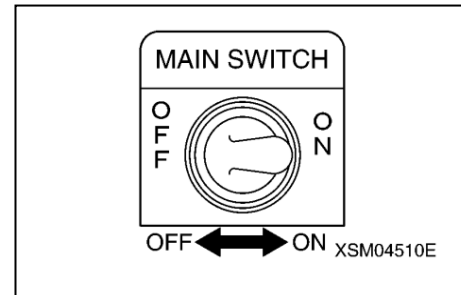

[3] MONITOR DISPLAY (3)

In the event that the abnormal signal detector of the controller serves, the Monitor display indicates error codes.

CAUTION

In the event that the monitor display (3) indicates an error code, settle the error as follows:

1. Push the Reset button of the Transmitter.
2. When the practice as above 1. results in another error code, turn the Receiver OFF, then start it again.
3. When the practice as above 2. results in a further error code, it is suspected that the Transmitter or Receiver has faults; contact us or our agents for services.

★ For detail of error codes, refer to “10. TROUBLE SHOOTING”.

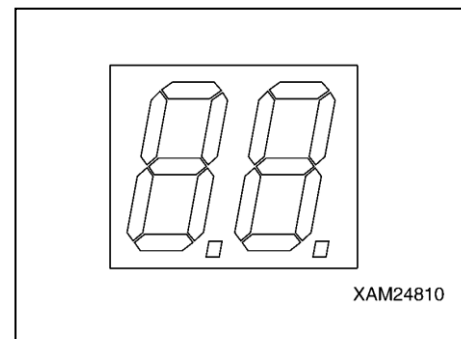

[4] CABLE CONNECTOR

Connect the connection cable from the Transmitter, here.

CAUTION

- Before attaching the connection cable to the cable connector (4), always confirm that the Main switch (2) is in the OFF position. After insertion, secure the plug by the screw.
- Always apply the water proof cap while the remote control is not in use.
- In the condition where the remote control is not provided, this cable connector is redundant. Always keep the water proof cap attached.

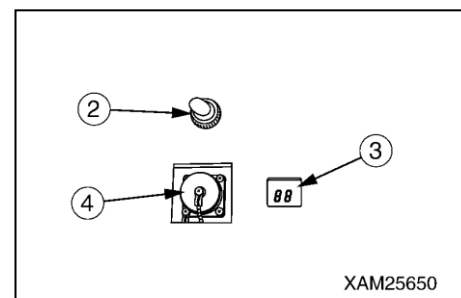

5.2 FUSE IN THE RECEIVER

⚠ CAUTION

- For any tests or replacement of a fuse, always turn OFF the Main switch of the Control box, before removing it.
- The fuse must be replaced with the same type of glass tube fuses, and of the same rating.

CAUTION

A fuse is inserted in the (+) line of the main power supply of the Receiver as a protective circuit of internal devices and prevents circuits from burning out.

- A glass tube fuse is employed. In the event where the fuse is corroded and shows white dust, or when a loose condition is recognized, always replace it with a new one.
- When the fuse is blown, never fail to examine the circuit for the cause and repair it before replacing the fuse.
- The fuse must be replaced with the same type of glass tube fuses, and of the same rating.

The fuse is placed inside the Receiver.

Test and replacement of the fuse shall be practiced as follows:

1. Remove the receiver protection cover.
2. Remove the side cover of the receiver body.
3. Pull out the fuse from its clips, then examine it.
4. Insert a new fuse or the examined fuse to its original position.

[Fuse class]

Type : Glass tube fuse

Rating: 10A

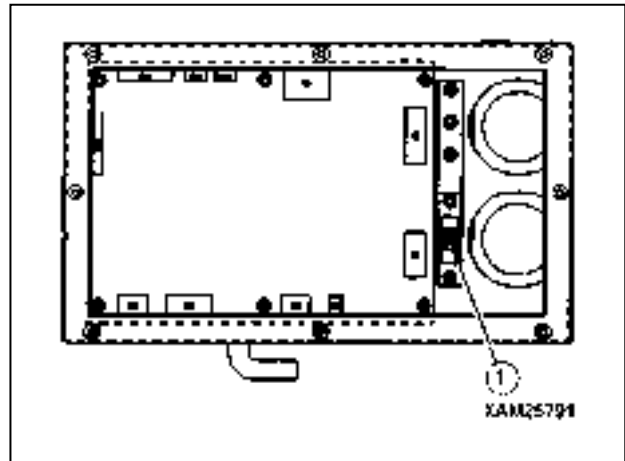

6. MODE SETTING OF THE TRANSMITTER

This device provides the “A MODE” in which the initial values of the Transmitter are established, the “OUTRIGGER MODE” in which the outriggers are set or stowed, and the “CRANE MODE” where the Crane is operated. This device is designed to switch to the applicable mode for the operation by the Transmitter.

6.1 A MODE

⚠ WARNING

- To perform A Mode setting, turn ON the starter switch in the machine body first, set the Travelling lever stand to "Crane Operation" Position next, then turn ON the main switch of the Receiver.
- Before the setting of values for A MODE, ensure that “A MODE” is correctly indicated in the LCD screen. Otherwise, un-expected motion of the Crane may result in a serious accident, due to entry of values in the other mode, by mistake.

6.1.1 OPENING A MODE SCREEN

Push the Speed/Mode button and Power switch jointly for 2 seconds. A message as “A MODE” appears in the LCD screen for 2 seconds.

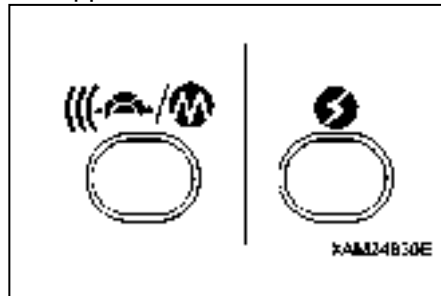

MAEDA RADIO
REMOTE CONTROL



A MODE

XAM24840E

6.1.2 MESSAGES IN THE A MODE SCREEN

Refer to the figure on the right for the A MODE screen:

It contains eight function items ((1) to (8)) and the Exit command ((9)).

NOTES

In the A MODE, following applicable items are adjustable, as required:

- (1) “Contrast ratio” of LCD screen
- (2) “Loudness control”
- (3) The “Engine speed limit”, controllable by the Accelerator lever.
- (4) LCD backlight, “Time for lighting, until the auto-cut”.
- (5) “Auto Shut-OFF time” of the Transmitter power.
- (6) “Low idling rate” of the engine. (Idling only while the crane operation levers are manipulated.)
- (7) Reset of “user values” by the speed set-up mode.
- (8) Version information of the Transmitter hardware.

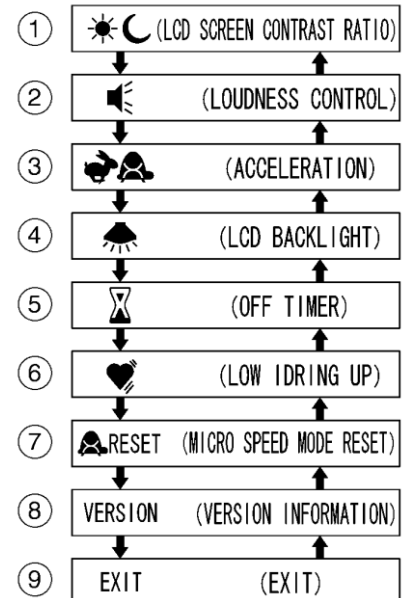

XAM28370E

To switch the function item to another, or to change the setting value of the function, use the Hook raising and lowering lever.

Then, to fix the value in the function, push the Setting button.



XAM25650E

[1] LCD SCREEN CONTRAST RATIO

CAUTION

The LCD screen may be illegible when it is set too light or too dark, which may prevent correct operations. Adjust its contrast adequately for a comfortable read.

Adjust the contrast ratio of the LCD screen:

- Shift the cursor (▲ or ▼) using the Hook raising and lowering lever.
 - To darken: Push the upper end of the Hook raising and lowering lever.
 - To lighten: Push the lower end of the Hook raising and lowering lever.
- When the desired contrast is obtained, push the Setting button. The condition obtained in above 1 will be fixed and the display returns to the A MODE screen.

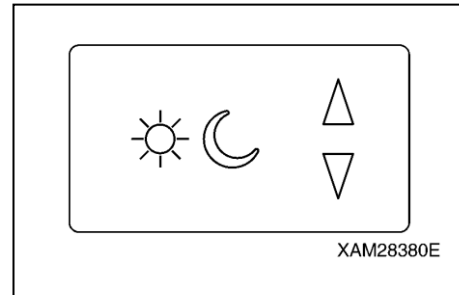

[2] LOUDNESS CONTROL (available only for units with optional voice message)

Select either to use or to cancel the voice message.

- Shift the cursor (▲ or ▼) using the Hook raising and lowering lever and select "ON" or "OFF".

When the voice message is required, select "ON", otherwise, select "OFF" to cancel it.

The factory setting for this function is "OFF".
- When the mode of the voice message is determined, push the Setting button. The condition obtained in above 1 will be fixed and the display returns to the A MODE screen.

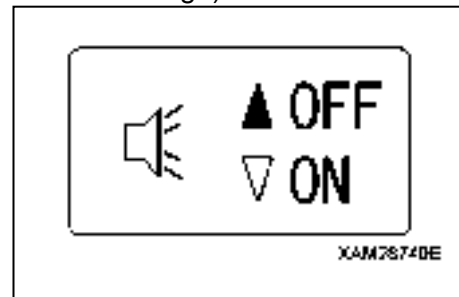

[3] ACCELERATION

Adjust the engine speed limit, controllable by the Accelerator lever:

- Shift the cursor (▲ or ▼) using the Hook raising and lowering lever. When all the bars light, the speed limit is at maximum, otherwise, when the all are OFF, it is at minimum.
- When the suitable rev limit is obtained, push the Setting button. The value obtained in above 1 will be fixed and the display returns to the A MODE screen.

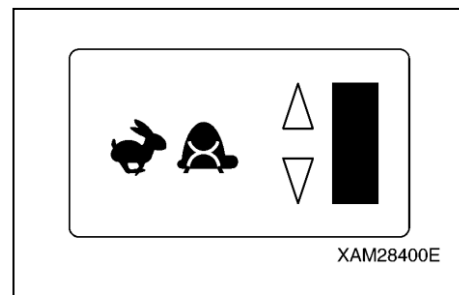

[4] LCD BACKLIGHT

Adjust the length of time in which the LCD backlight is lit, after your finger is released from each of the lever.

- Shift the cursor (▲ or ▼) using the Hook raising and lowering lever and select the preferred time.

The elapse time adjust is by 4 steps, OFF, 1 sec., 3 sec., or 4 sec.

The factory setting for this function is "1 second".
- When the desired time is obtained, push the Setting button. The elapse time in above 1 will be fixed and the display returns to the A MODE screen.

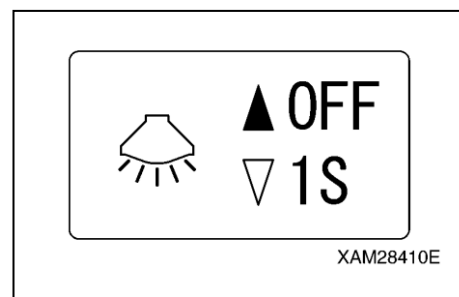

[5] OFF TIMER

Adjust the Auto shut-OFF time of the Transmitter power.

1. Shift the cursor (▲ or ▼) using the Hook raising and lowering lever and select the preferred time.

The Auto shut-OFF adjust is by 3 steps, 5 min., 10 min., or 15min.

The factory setting for this function is “5 minutes”..

2. When the desired time is obtained, push the Setting button. The time in above 1 will be fixed and the display returns to the A MODE screen.

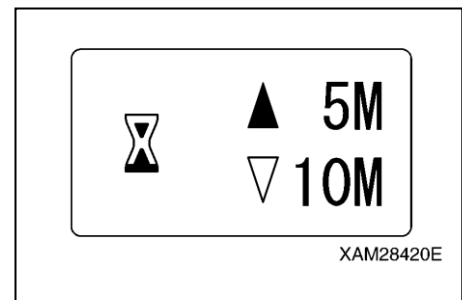

[6] LOW IDLING UP

CAUTION

The low idling rate regulated by this idling-up function is valid only during crane operation when levers are manipulated. Once the lever is released, the low idling rate is reset to the normal rate.

Adjust the engine's low idling rate to higher than the normal rate, whilst the crane operation levers are manipulated.

1. Shift the cursor (▲ or ▼) using the Hook raising and lowering lever. When all the bars light, the idling up is in the maximum, otherwise, when the all are OFF, the idling up is canceled.
2. When the suitable idling up rate is obtained, push the Setting button. The value obtained in above 1 will be fixed and the display returns to the A MODE screen.

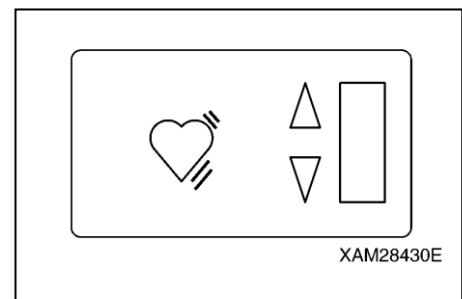

[7] MICRO SPEED MODE RESET

Select either to reset or preserve the value at the micro speed mode.

1. Shift the cursor (▲ or ▼) using the Hook raising and lowering lever and select “N” or “Y”.

To reset, select “Y”, otherwise, select “N” to preserve.

2. Whether reset is fixed or not, push the Setting button. The status in above 1. will be fixed and the display returns to the A MODE screen.

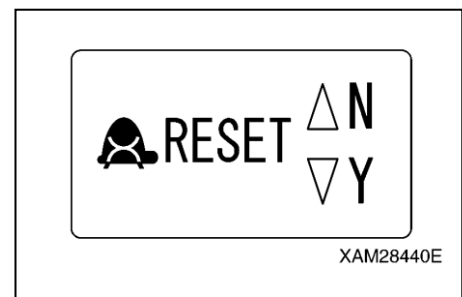

[8] VERSION INFORMATION

Push the Setting button, so that version information of the Transmitter hardware is displayed. Another push of the same button makes the display returns to the A MODE screen.

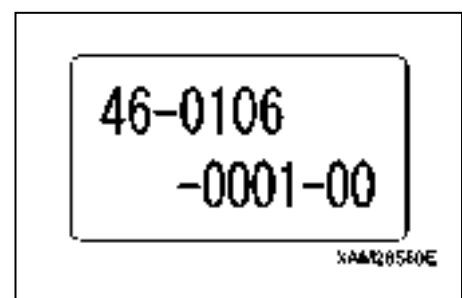

[9] EXIT

CAUTION

Once setting-up the desired function items are completed, do not forget to practice the termination procedure, below. Otherwise, when this process is not correctly terminated, the latest setting will not become valid.

1. Once setting-up the desired function items are completed, ensure that the display has returned to the A MODE screen.
2. Shift the cursor (▲ or ▼) using the Hook raising and lowering lever and select "EXIT".
3. Push the Setting button, which will terminate the "A MODE" and turn the mode to "the "CRANE MODE".



6.1.3 AN EXAMPLE FOR SETTING IN THE A MODE

Hereunder is a procedure to change the time of the "OFF timer", from "5 minutes" of the factory setting, to 10 minutes:

1. Use the Hook raising and lowering lever and shift the cursor (▲ or ▼) to the side of the function item to be changed.

2. When the cursor comes to the side of the "OFF timer", push the Setting button.

Now, the "OFF timer" is selected and the cursor (▲) appears next to "5 minutes", as the current value.

3. Use the Hook raising and lowering lever so that the cursor (▼) comes to the side of "10 minutes", then push the Setting button.

Now, the "OFF timer" setting is 10 minutes.

4. Shift the cursor (▲ or ▼) using the Hook raising and lowering lever and select "EXIT", then push the Setting button.

Now the mode exits from the "A MODE" and is turned to the "CRANE MODE".

CAUTION

- Once setting-up the desired function item are completed, do not forget to practice the termination procedure, above. Otherwise, when this process is not correctly terminated, the latest setting will not be valid.
- Change of the other function item setting is available by the same procedure. In such event, correctly exit from the A MODE, without fail.

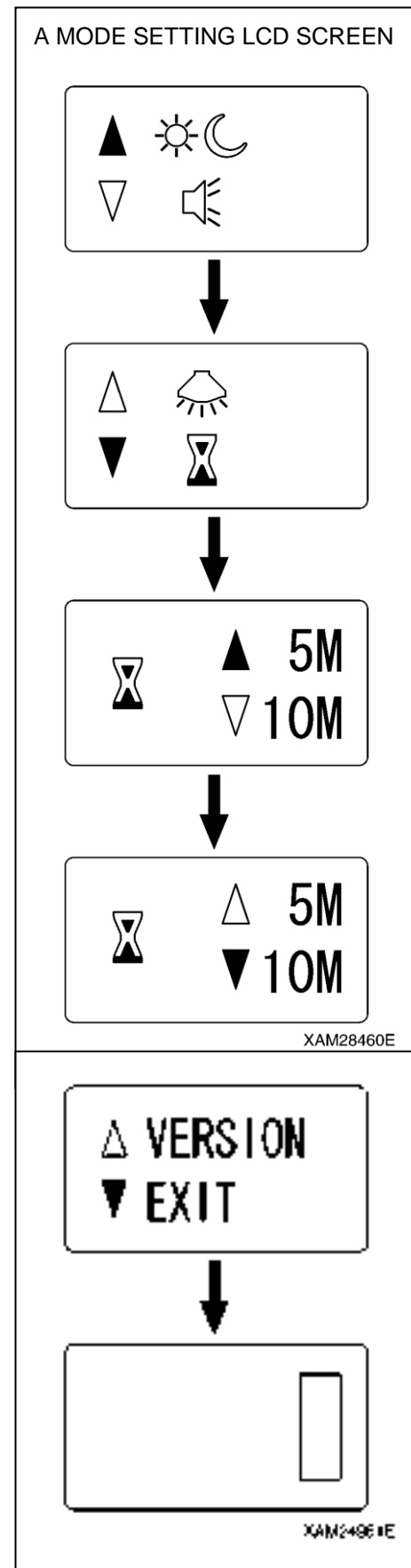

6.2 PROCEDURE IN THE OPERATION MODE

CAUTION

When the Main switch of the Receiver is turned ON, its abnormal signal detector automatically starts, first. Please allow it for 3 to 4 seconds, without using any levers, buttons and the Accelerator lever.

NOTES

- For changes between the modes, always turn OFF the power, once, then push the Power button again to power ON.
- While using a mode other than the “CRANE MODE”, when you turn OFF the power by the Power switch and turn it ON, again (i.e., you keep waiting for 2 seconds or more), the mode is automatically set to “CRANE MODE”.
When you want to continue the operation in the previous mode, call the appropriate mode, again.

6.2.1 CALL OUT CRANE MODE

1. Push the Power button to turn ON the Transmitter.

The “Crane mark” is displayed in the LCD screen for about 2 seconds.

NOTES

In case the power is already ON, turn OFF once, and then push the Power button again for power ON.

2. When the “Crane mark” in the LCD screen disappears in 2 seconds, the “CRANE MODE” is automatically called out.



XAM24670E



XAM24980E

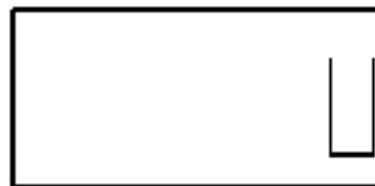

XAM24951

6.2.2 CALL OUT OUTRIGGER MODE

NOTES

The OUTRIGGER MODE consists of “Outrigger collective setting mode (ALL)” and “Outrigger individual setting mode”. Use respective modes as shown below:

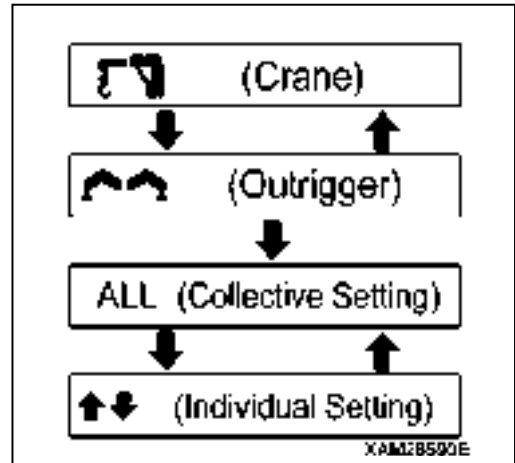

1. Push the Power button to turn ON the Transmitter.

The “Crane mark” is displayed in the LCD screen for about 2 seconds.

NOTES

In case the power is already ON, turn OFF once, and then push the Power button again for power ON.

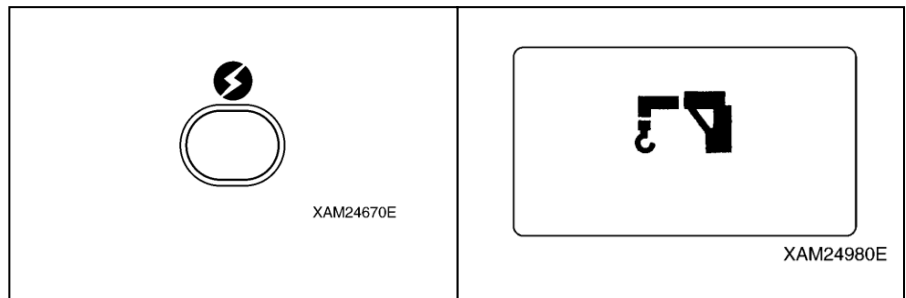

2. While the “Crane mark” is shown in the LCD screen (for about 2 seconds), push the Speed/Mode button for 2 seconds.

The LCD provides the screen for selecting “CRANE MODE” or “OUTRIGGER MODE”.

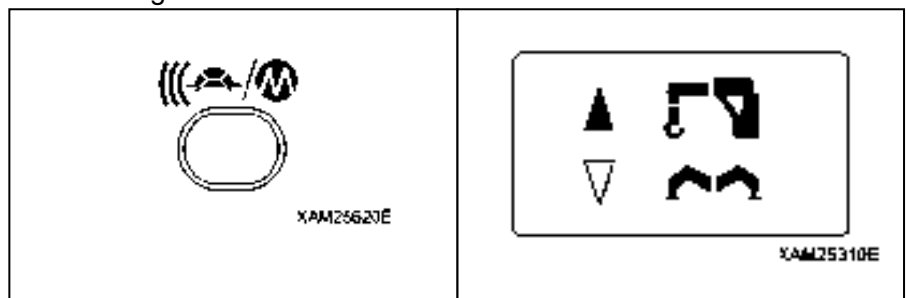

3. Use the Hook raising and lowering Lever to shift the cursor (▲ or ▼), and push the Setting button when the cursor points to the “OUTRIGGER”.

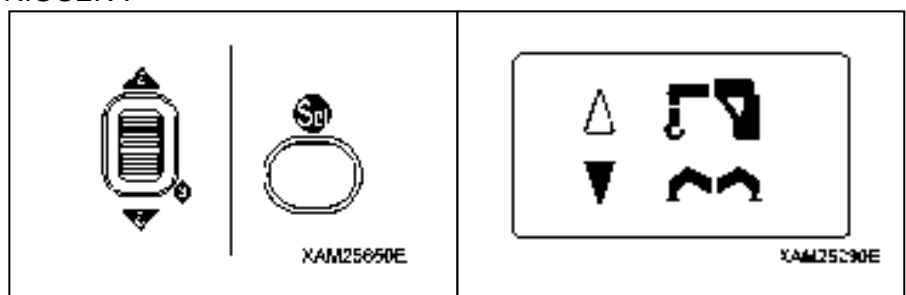

4. The operation mode is already switched to the “OUTRIGGER MODE”, thus the “Outrigger mark” is exhibited.

Soon after, it enters into “Outrigger collective setting mode”, then the mark turns to “Outrigger collective setting mode (ALL) “.

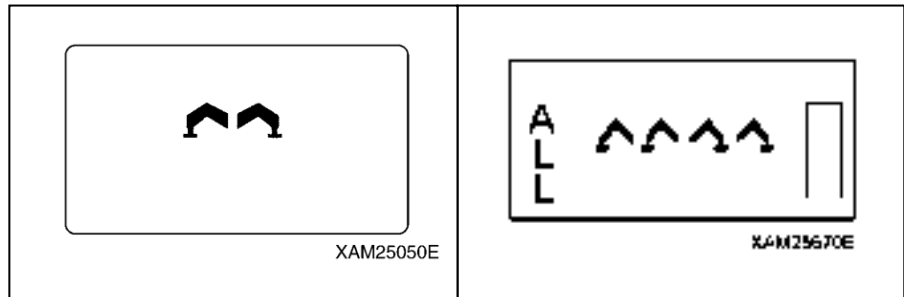

5. To shift to “Outrigger individual setting mode”, push the Speed/Mode button, while the LCD screen shows the “Outrigger collective setting mode (ALL)”. Then the mode is switched to “n”; the mark turns to “Outrigger individual setting mode (↑↓)”.

NOTES

Switching between “Outrigger collective setting mode” and “Outrigger individual setting mode” is alternated by each push of the Speed/Mode button.

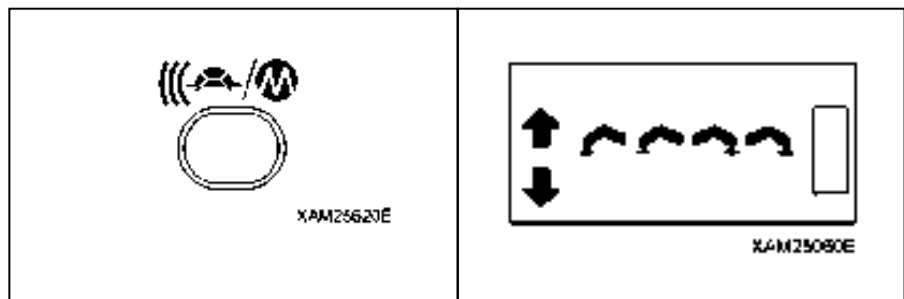

7. CHECKING BEFORE OPERATION

WARNING

Precautions shown in this section must be practiced prior to starting work, without fail. Serious injury or death may arise when these checks are neglected. Also refer to the section of “OPERATION 2.1 Checking before Operation” for checking of the crane structure. In the event where any failure is revealed during checking, repair it, or contact us or our agents for services.

7.1 CHECKING BEFORE STARTING ENGINE

7.1.1 CHECKING BEFORE TURNING ON THE TRANSMITTER

WARNING

For checking before Turning ON the Transmitter, ensure that the engine starter key is in the OFF position, and also the Receiver main switch is OFF. Otherwise, the engine may un-expectedly start and cause serious injury or death, while checking the Transmitter.

Perform the following inspections while the Transmitter power is OFF:

- Check the control levers, operation buttons, LCD screen, Accelerator lever and Grip for oily dirt or other contaminants.

Scrub away any dirt with a clean cloth.

- Check for foreign bodies such as particles of small stone or sand, caught into small openings in the vicinity of the control levers and/or Accelerator lever.

If found, remove such particles completely. In the event where such particles are caught in the small openings in the vicinity of the control levers and/or acceleration lever, they may disturb correct operations and cause un-expected motion of the Crane which may result in a serious accident.

- Check for any cracks and/or damage to the Transmitter enclosure, or impairment to the rubber cover of the operation levers and control buttons.

Repair such cracks or damage immediately.

Such cracks or damage may allow water to enter inside and bring troubles or failures to the Transmitter and cause a serious hazard.

- Check the smooth and correct actions of each of the operation lever and control button, and the Accelerator lever, also that they smoothly return to the each neutral position when the finger is released. Repair the operation levers, Accelerator lever and/or control button without delay, when any of them show an incorrect action.

Any failure to the operation levers, Accelerator lever and/or control button brings troubles or failures and may cause a serious hazard.

- Check the connection cable for any cracks, damage, bent or loose connection or damage in the connector section.

Repair or replace with a new cable, where such cracks, damages, or loose connection are present.

7.1.2 CHECKING AFTER TURNING ON THE TRANSMITTER

At the moment when the Transmitter is powered ON, make checks on following items:

[1] VERIFICATION OF THE LCD SCREEN SIGN AT POWER-ON

Push the Power switch to turn ON the Transmitter.

At this moment, confirm the mark as shown below, in the LCD screen.

NOTES
In two seconds of this condition, it automatically enters into the "CRANE MODE" .

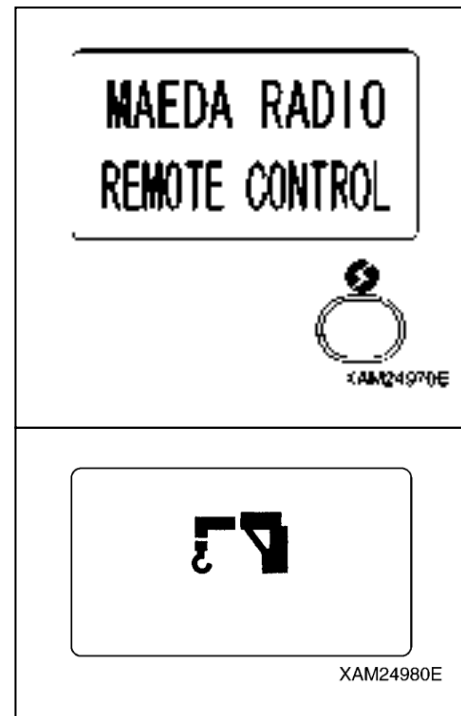

[2] VERIFICATION OF THE LCD SCREEN SIGN AT THE "CRANE MODE"

1. Pull the Accelerator Lever to the full and check that acceleration rate indicated in the right part of the LCD screen is in the full throttle (with all the bars present).

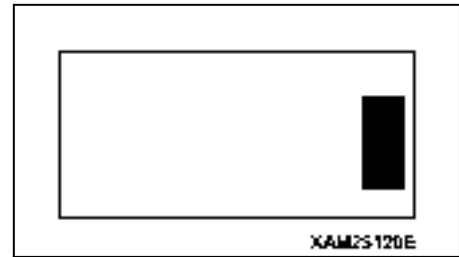

2. Next, slack the Accelerator Lever slowly and check that acceleration rate indicated in the right part of the LCD screen decreases, reflecting the Accelerator Lever operation.

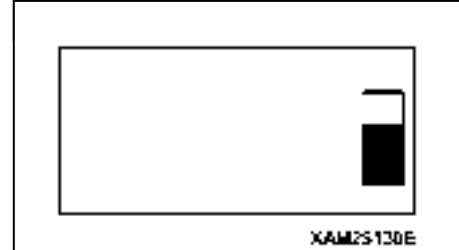

3. Then release your finger from the Accelerator Lever and check that acceleration rate indicated in the right part of the LCD screen shows idling (with all the bars absent).

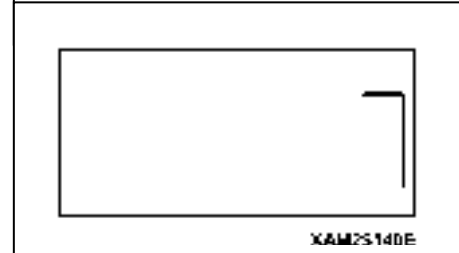

4. Manipulate each operation lever and verify that each indication in the LCD screen is correct.

5. Manipulate each operation button and verify that each indication in the LCD screen is correct.

6. Verify that "START" is correctly displayed in the LCD screen when the Start/Reset button is pushed.

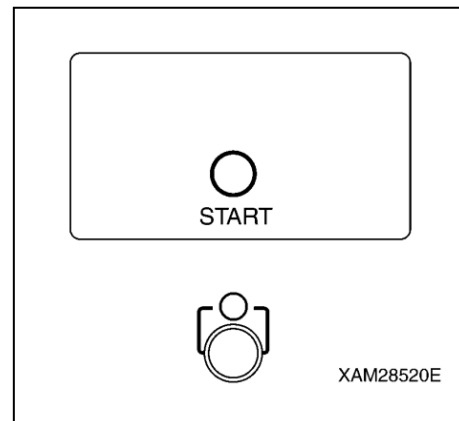

7. Also, verify that "STOP" is correctly displayed in the LCD screen when the Stop/EMO button is pushed.

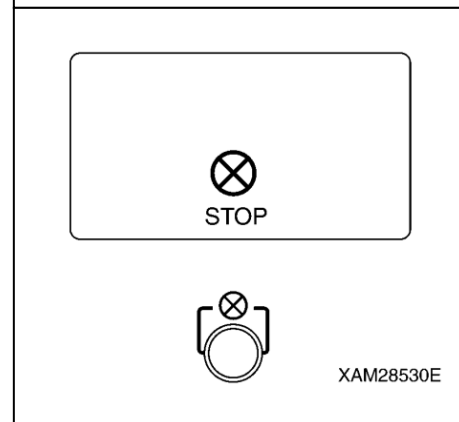

[3] VERIFICATION OF THE LCD SCREEN SIGN AT THE “OUTRIGGER MODE”

1. Push the Power switch once to turn OFF the Transmitter.

2. Push the Power switch again to turn ON the Transmitter.

The “Crane mark” is displayed in the LCD screen for about 2 seconds.

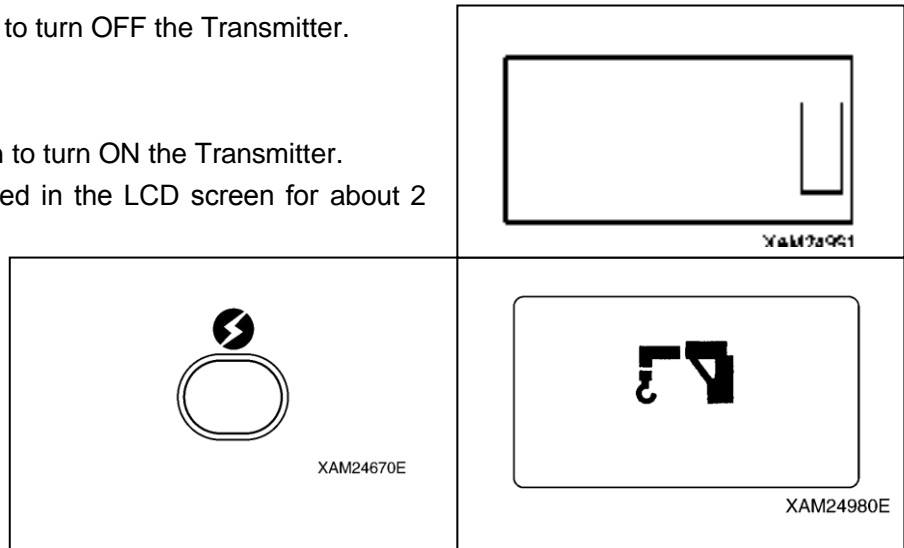

3. While the “Crane mark” is shown in the LCD screen (for about 2 seconds), push the Speed/Mode button for 2 seconds.

The LCD provides the screen for selecting “CRANE MODE” or “OUTRIGGER”.

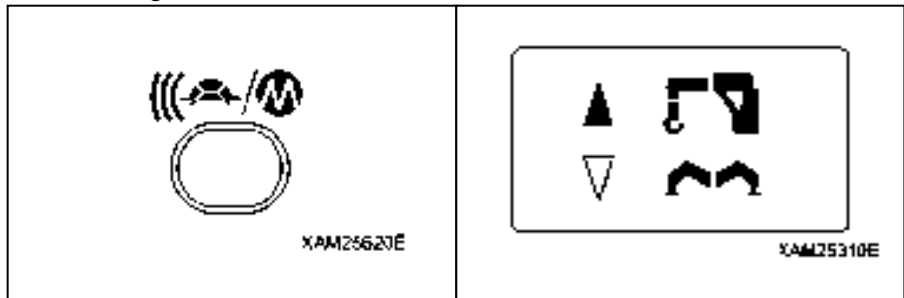

4. Use the Hook raising and lowering Lever and shift the cursor (▲ or ▼), and push the Setting button when the cursor points out the “OUTRIGGER”.

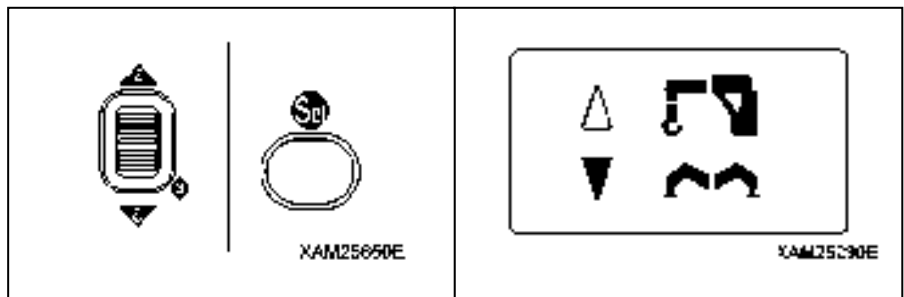

Here, confirm that the “Outrigger mark” is exhibited, then it enters into the “Outrigger collective setting mode (ALL)”, soon after.

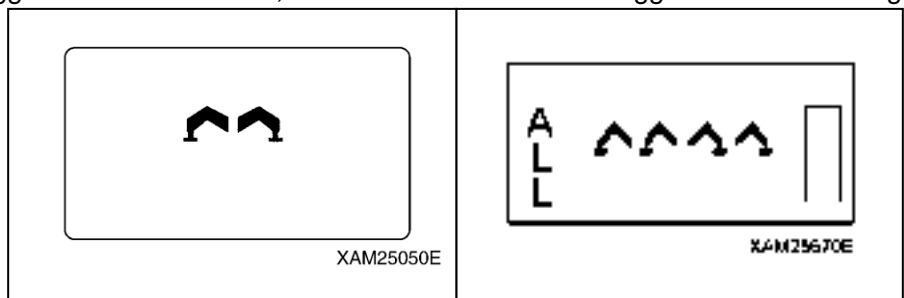

5. Manipulate each operation lever and verify that each indication in the LCD screen is correct.

NOTES

In Outrigger collective setting mode (ALL), operation of any control lever will only result the same indication.

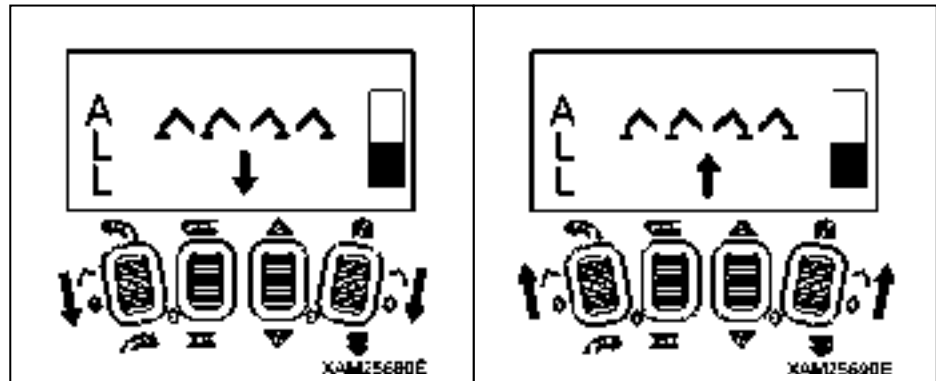

6. To shift to “Outrigger individual setting mode (↕)”, push the Speed/Mode button, while the LCD screen shows the “Outrigger collective setting mode (ALL)”.

Here, confirm that the “Outrigger individual setting mode (↕)” is exhibited.

NOTES

Switching between “Outrigger collective setting mode” and “Outrigger individual setting mode” is alternated by each push of the Speed/Mode button.

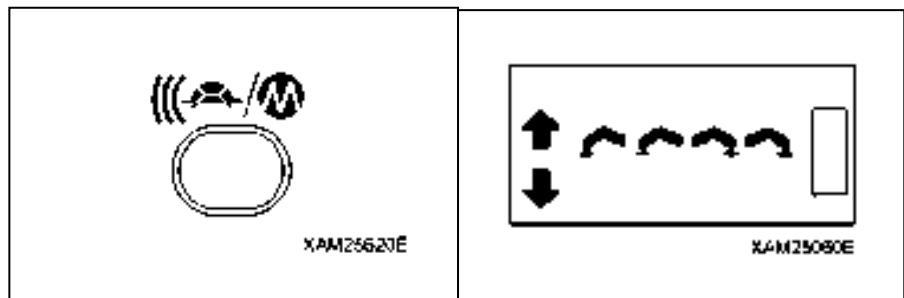

7. Manipulate each operation lever and verify that each indication in the LCD screen is correct.

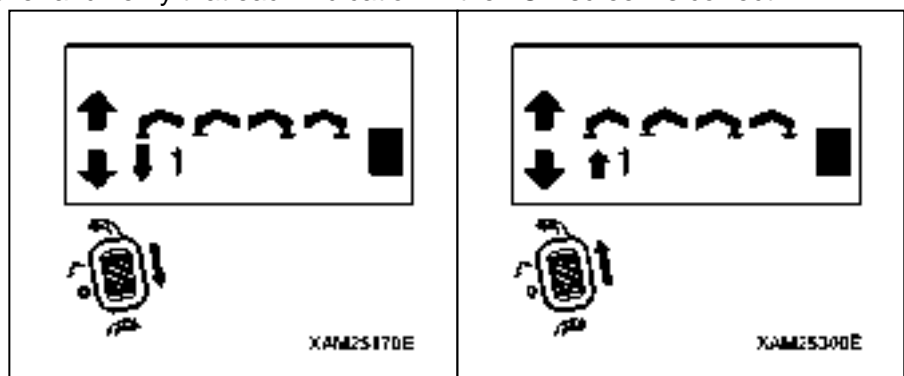

7.1.3 CHECKING RECEIVER

Perform the following inspections:

- Check the Control Box (1), Main Switch (2), Monitor display (3), and Cable Connector (4) for oily dirt or other contaminants.

Scrub away the dirt with a clean cloth.

- Check for any cracks and/or damages to the Control Box (1) or Monitor display (3). Repair any cracks or damage immediately. Cracks or damage may allow water to enter inside and bring troubles or failures to the Receiver, and may cause a serious hazard.

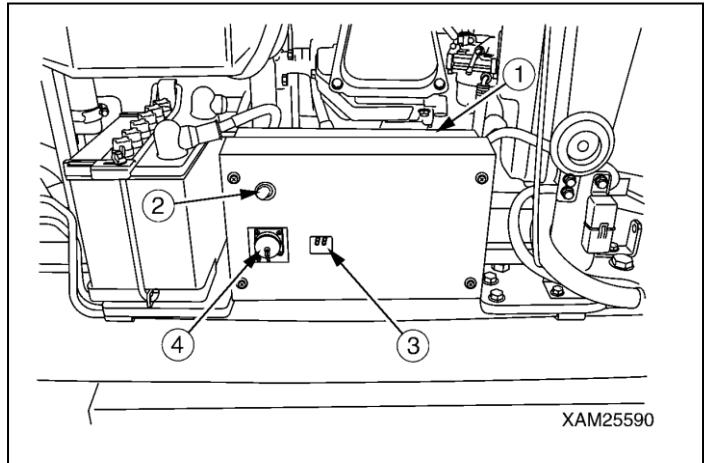

- Check the Main switch (2) and Cable Connector (4) for the loose conditions or damages.

Repair immediately when any such loose conditions or damages are found.

Such loose conditions or damages may cause errors or faults of the Receiver, which may result in a serious hazard.

- Toggle the Main switch (2) to ON and OFF alternately to verify that power is correctly turned ON or OFF.
- Turn ON the Transmitter, then toggle the Main switch (2) to ON, in addition, and confirm next that the two dots in the Monitor display as shown in the figure in the light blink.

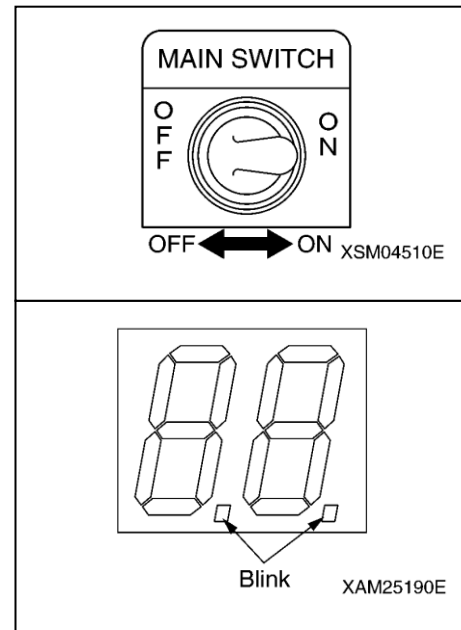

NOTES

In the condition that the Transmitter is not powered ON, or reception has an error, the Monitor display shows the error code, "E2", when the Receiver is turned ON.

7.2 CHECKING AFTER STARTING ENGINE

WARNING

Precautions shown in this section must be practiced prior to starting work, without fail. Serious injury or death may arise when these inspections are neglected. Further, refer to the section of "OPERATION 2.1 Checking before Operation" for checking of the crane structure. Whenever any failures are revealed during such inspections, repair them, or contact us or our agents for services.

7.2.1 VERIFICATION FOR THE ENGINE START AND STOP

WARNING

- Ensure that the boom and outriggers are in the stowed position, entirely . In the case where they are not in those positions, manipulate applicable levers of the Crane to make them stowed. Otherwise, the Transmitter operation may cause damage to the Crane or tipping that results in serious injury or death.
- The Crane is inoperable in such an event where the LCD screen in the Transmitter shows an error message or the Monitor display in the Receiver shows an error code. Without fail, examine the cause of the error and perform appropriate service when any fault is identified, or contact us or our agents for services.

[1] CHECKING ENGINE START OPERATION

1. Position the Starter Switch of the Crane to ON.
2. Set the travelling stand of the Crane to CRANE position.
3. Turn ON the Main switch of the Receiver.
4. Push the Power switch of the Transmitter, to power ON.
5. Then push the Horn button and confirm that the horn toots.
6. Use the Start/Reset button to check that the engine starts properly.
7. Check whether the indication "START" appears in the LCD screen, at that time.

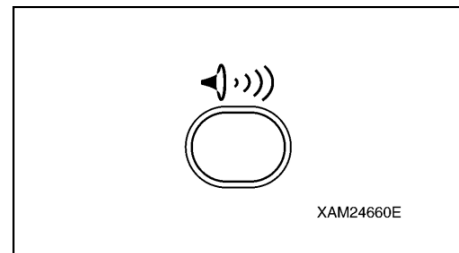

CAUTION

Prior to starting the engine, perform the following practices of the Crane.

1. Set the Acceleration Lever to the medium speed (nealy middle in its stroke).
2. Pull out the choke knob.
3. Return the choke knob to its initial position, when the engine starts.

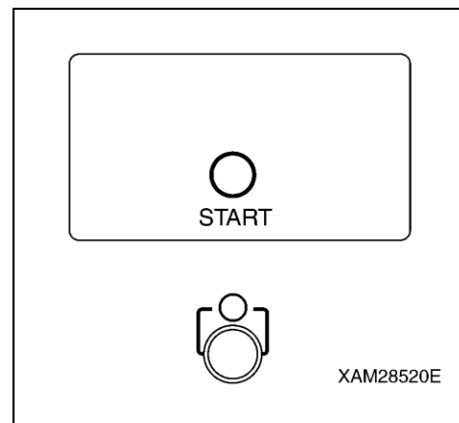

[2] CHECKING ENGINE EMERGENCY STOP OPERATION

1. When the engine is started as in the above [1], try the Stop/EMO button to confirm that the engine absolutely stops.
2. Then check whether the indication "STOP" appears in the LCD screen.
Also confirm that the Monitor display in the Receiver shows the error code, "E1", at that time.

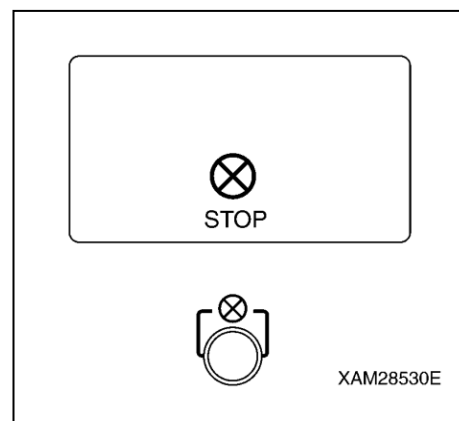

7.2.2 CHECKING “OUTRIGGER MODE” OPERATION

⚠ WARNING

The Crane is inoperable during an event where the LCD screen in the Transmitter shows an error message or the Monitor display in the Receiver shows an error code. Without fail, examine the cause of the error and perform appropriate service when any fault is identified, or contact us or our agents for services.

1. Refer to "Operation 2.13.2 Outrigger Setting Operation [1] Tasks to be Performed upon Engine Stop", and extend all the 4 outriggers.
2. Position the Starter switch of the Crane to ON.
3. Set the travelling stand of the Crane to CRANE position.
4. Turn ON the Main switch of the Receiver.
5. Push the Power switch of the Transmitter, to power ON.
6. Switch the operation mode to the “OUTRIGGER MODE” and confirm that “ALL” is indicated in the LCD screen.

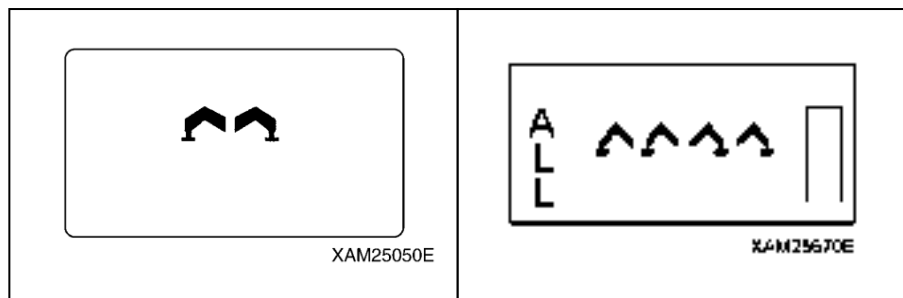

7. Push the Start/Reset button and start the engine.

CAUTION

Prior to starting the engine, perform following practices in the Crane.

1. Set the Acceleration Lever to the medium speed (nealy middle in its stroke).
2. Pull out the choke knob.
3. Return the choke knob to its initial position, when the engine starts.

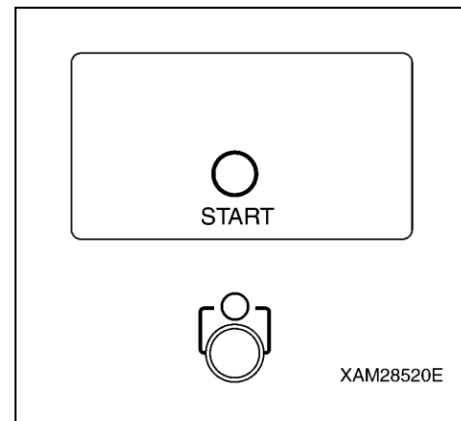

8. While Manipulating respective control lever to "OUT" position (downward) or "IN" position (upward) and trigger the Accelerator Lever to check that all the outriggers reflect the control lever operation concurrently.

NOTES

In Outrigger collective setting mode (ALL), operation of any control lever controls all the outriggers in the same manner and at the same time.

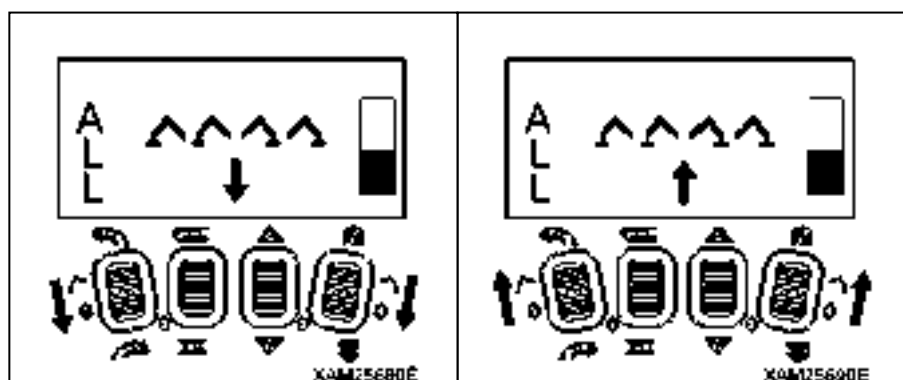

9. Push the Speed/Mode button.

Then confirm that the “Outrigger individual setting mode (↕)” is exhibited.

NOTES

Switching between “Outrigger collective setting mode ” and “Outrigger individual setting mode” is alternated by each push of the Speed/Mode button.

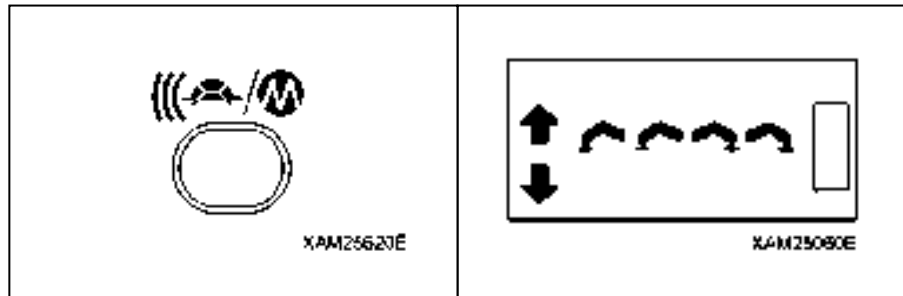

10. Push the Start/Reset button and start the engine.

11. Use the Slewing/No.1 Outrigger operation lever, to both the “Extend (lower)” and “Retract (upper)” area, and check that the No. 1 outrigger follows the lever operation.

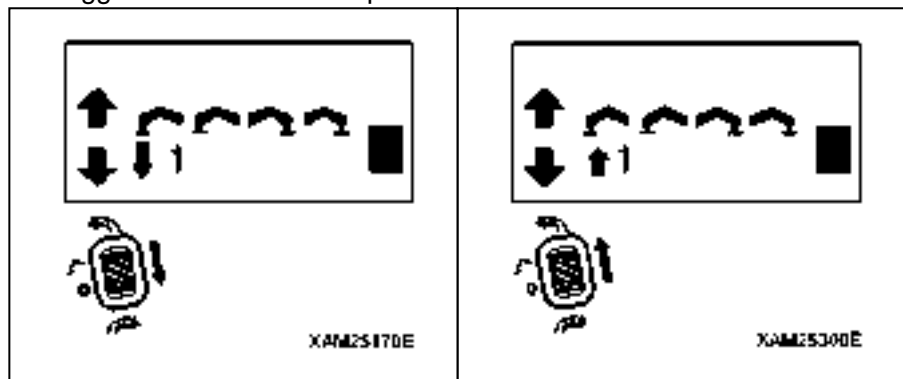

12. Try other outrigger operation levers with the same manipulation and confirm that the outriggers correctly respond to the lever control.

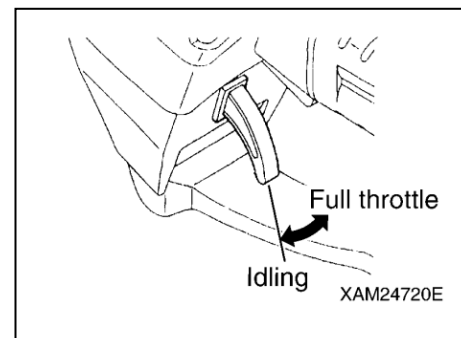

CAUTION

To change from "OUTRIGGER MODE" to “CRANE MODE”, turn OFF the power using the Power switch and turn it ON again. Then the mode is automatically set to “CRANE MODE”.

7.2.3 CHECKING “CRANE MODE” OPERATION

⚠ WARNING

- Ensure that all the outriggers are securely settled, before starting crane operations. Any crane operations where outriggers are improperly used may cause the crane to tip over or other serious accidents.
- The Crane is inoperable at such times where the LCD screen in the Transmitter shows an error message or the Monitor display in the Receiver shows an error code. Without fail, examine the cause of the error and perform appropriate service when any fault is identified, or contact us or our agents for services.

1. Start the engine by the Starter switch of the Crane.

CAUTION

Prior to starting the engine, perform the following practices with the Crane.

1. Set the Acceleration Lever to the medium speed (about middle of its stroke).
2. Pull out the choke knob.
3. Return the choke knob to its initial position, when the engine starts.

2. Refer to the contents of “OPERATION 2.15 Operations before Crane Operations” and “OPERATION 2.16 Crane Operation Position” and configure the Crane as shown in the figure, right.

3. Then turn ON the Main switch of the Receiver.

4. Push the Power switch of the Transmitter to power ON.

5. Enter into “CRANE MODE”; confirm that the indication as “CRANE MODE” is displayed in the LCD screen.

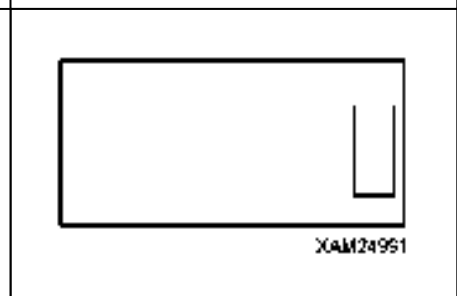
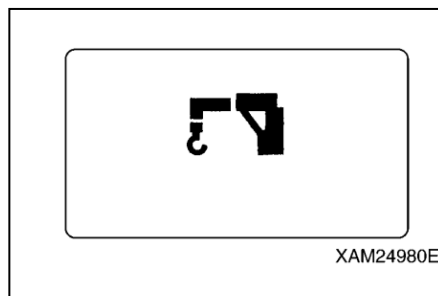
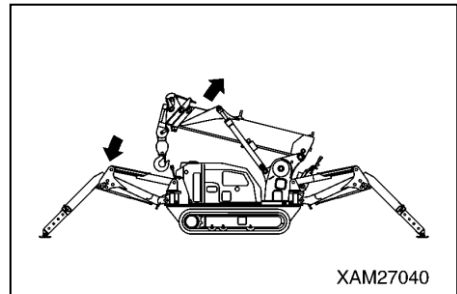

6. Use the Boom derricking lever to the both “Raise (upper)” and “Lower (lower)” area, pull the Accelerator lever and check that the boom follows the lever operation.

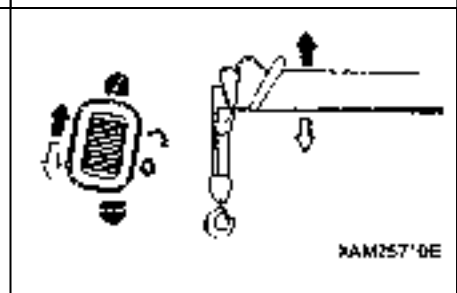

7. Raise the boom to a sufficient angle (approximately 60 degree) using the Boom derricking lever, pushing to the “Raise (upper)” area.

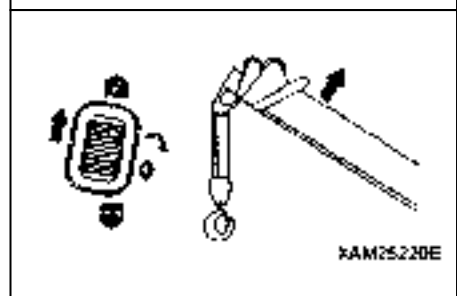

8. During the Hook raising and lowering lever manipulation, of the “Raise (upper)” and “Lower (lower)” area respectively, pull the Accelerator lever and check that the hook follows the lever operation.

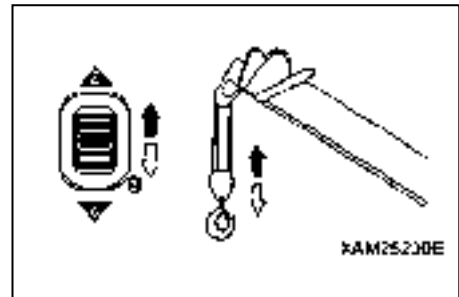

9. Using the Hook raising and lowering lever to the “Lower (lower)” area, lower the hook as much as possible.

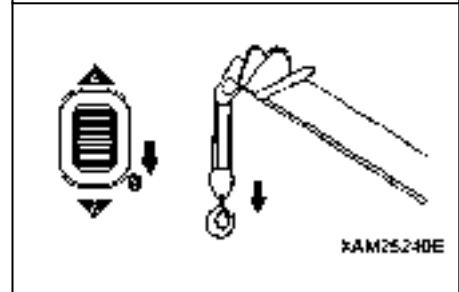

10. During the Boom telescoping lever manipulation, to the “Extend (upper)” and “Retract (lower)” area respectively, pull the Accelerator lever and check that the boom follows the lever operation.

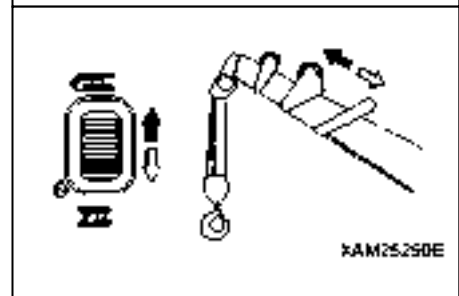

11. Using the Hook raising and lowering lever to the “Raise (upper)” area, hoist the hook.

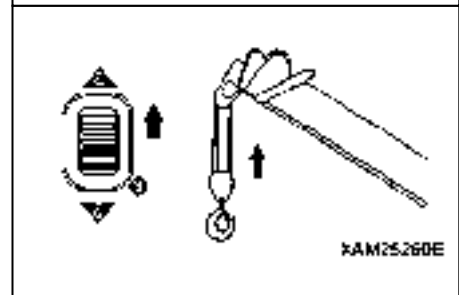

12. During the Slewing lever manipulation, to the “Counter clockwise (upper)” and “Clockwise (lower)” area respectively, pull the Accelerator lever and check that the Crane follows the lever operation.

In addition, practice a slew around 360 degrees or more to check for any abnormal conditions

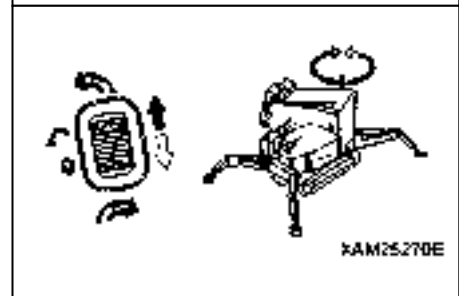

13. During each control lever manipulation of 6. through 12., above, slowly pull and release the Accelerator lever and confirm that the speed of each action follows the acceleration ratio.

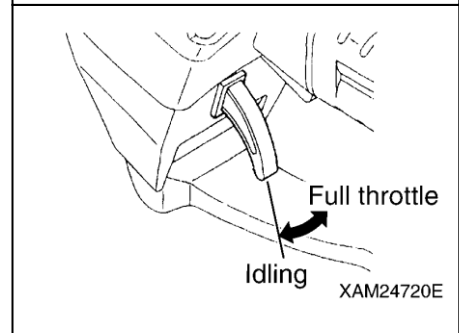

14. During each control lever manipulation of step 6 through step 12, above, push the Speed/Mode button, then try both “Micro speed command” and “Enhanced speed command” and confirm the speed of each operation corresponds to respective controls of “Micro speed command” and “Enhanced speed command”.

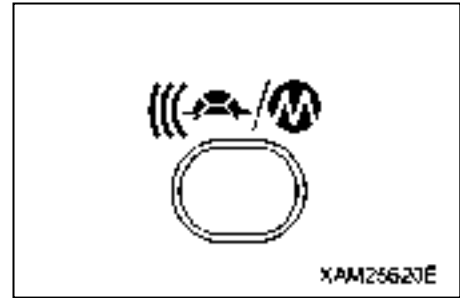

8. OPERATION

⚠ WARNING

- Never attempt to disassemble or modify the Transmitter or Receiver, which may cause an electrical shock or a fire.
- Avoid making an impact to the Transmitter by dropping or hitting. A damaged part of the enclosure allows water to enter inside that can cause trouble or failures and may result in a serious hazard, such as a malfunction or electrical shock.
In the event of dropping and damage, send the Transmitter to us or our agents for services.
- Never water-wash the Transmitter or Receiver; that allows water to enter inside and can cause trouble or failures and may result in a serious hazard, such as a malfunction or electrical shock.
- Both remote control operation and manual operation at the same time are not allowed.
That may cause un-expected behavior of the Crane and result in a serious hazard. The Crane must be operated by only one method. (Manual operation is not available, when the remote control is active.)
- Prior to starting the remote control operations, always conduct inspections of both the Transmitter and Receiver, in accordance with “INTERACTIVE REMOTE CONTROL 7. Checking before Operation”.

8.1 CAUTIONS BEFORE OPERATION

1. So that dropping the Transmitter is prevented, hook one end of the hook belt (16) to the Transmitter and attach another end to the operator's waist belt & etc.
2. Always conduct inspections of both the Transmitter and Receiver, in accordance with “REMOTE CONTROL 7. Checking Before Operation”.
3. Make sure that the receptacles (14) at the both ends of the connection cable are secured to both the Transmitter and Receiver, respectively.

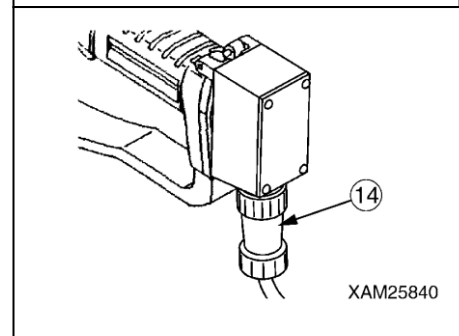
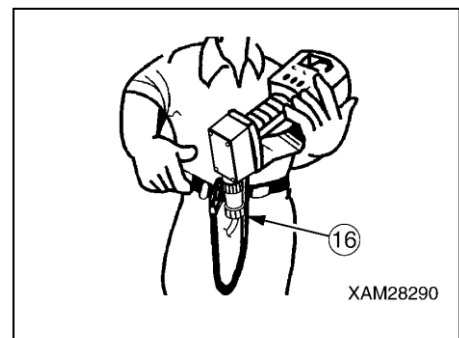

NOTES

- When it is required to change the initial values of settings such as the contrast of the Transmitter LCD screen, the light, or the OFF timer, first switch to “A MODE” for adjustment.
- In the event that the remote control operation is discontinued for the length of the “Auto shut -OFF time” or longer, during the crane operation, the Transmitter power will be automatically cut. To resume the remote control operation, turn ON the Transmitter and set each item of the operation mode again.

8.2 OPERATION IN OUTRIGGER MODE

⚠ WARNING

- Check for smooth and correct actions of each operation lever of the Transmitter, and that they smoothly return to each neutral position when the finger is released.
- Each operation lever of the Transmitter will be blocked by its stopper when it is moved fully. When it is blocked, do not attempt to push further, otherwise it may damage the Transmitter and cause faults and result in a serious accident.
- To toggle each operation lever to the opposite side, or to use another lever, always release the Accelerator lever, each time. Also, to operate the outriggers, manipulate the operation lever first, then pull the Accelerator lever. To stop the actuation of outriggers, release your finger from the Accelerator lever first, then discharge the operation lever.
- For the outrigger operations, always keep the engine speed in the low or middle range. Such operation in the high speed range makes the outriggers actuate too quickly, which may tip the Crane and result in a serious hazard.
- For the outrigger operations, always configure the Crane to the stow position. In the condition that the boom is raised or any load is lifted, it may cause a serious accident, such as tipping of the Crane.
- For the outrigger operations, always ensure that the position pin of each outrigger is securely inserted. In the event where the pins are missing, the Crane may be tipped over and cause a serious hazard.
- For the installation of outriggers, always extend them first in the “Extension mode”, then switch the mode to “Ground setting mode”. Lift each outrigger equally and gradually, until the Crane is properly elevated. For the stowing of Outriggers, lower each outrigger equally and gradually, until the Crane is grounded in the “Ground setting mode”, then switch to the “Extension mode” to retract them. Unless this order is followed, it may cause the crane to tip and result in a serious accident.

1. Ensure that the Main switch of the Receiver is in the OFF position.
2. Start the engine by the Starter switch of the Crane.

CAUTION

Prior to starting the engine, perform following practices on the Crane.

1. Set the Acceleration Lever to the medium speed (about middle of its stroke).
2. Pull out the choke knob.
3. Return the choke knob to its initial position, when the engine starts.

3. Then turn ON the Main switch of the Receiver.

NOTES

When the Main switch of the Receiver is turned ON, the abnormal signal detector circuit works for 3 to 4 seconds. During this time the Crane is not ready for operation.

4. Push the Power switch of the Transmitter to power ON.
Confirm that the LCD screen shows the mark as in the figure on the right and the “CRANE MODE” is automatically provided.

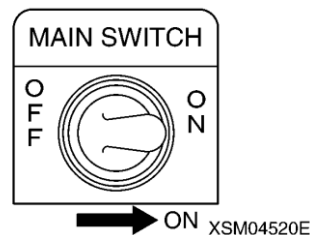

MAEDA RADIO
REMOTE CONTROL



NOTES

This Crane is equipped with four sets of outriggers and number labels (1) to (4) are fixed on each. These labels correspond to the number of each operation lever in the Transmitter. (See the figure in the right.)

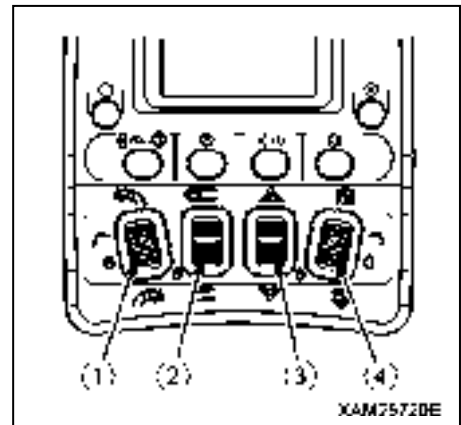

8.2.1 OUTRIGGER SETTING

⚠ WARNING

Avoid controlling outriggers collectively on ground conditions other than flat and leveled. Otherwise, 4 outriggers will not touch the ground consistently which makes the machine inclined and may result in tipping.

1. In accordance with “REMOTE CONTROL 6.2 Procedure in the Operation Mode”, enter into the “Outrigger collective setting mode”.

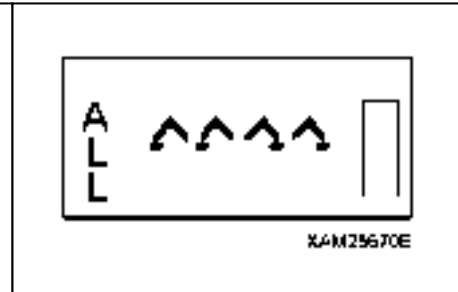
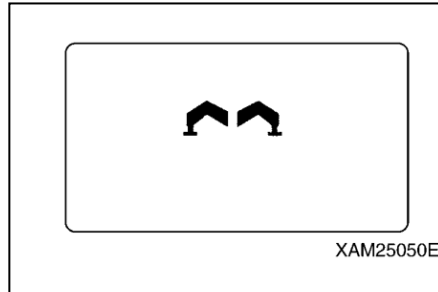

2. Turn one of the outrigger operation levers to “Extend (lower)” and pull the Accelerator lever slowly.

NOTES

In Outrigger collective setting mode (ALL), operation of any control lever controls all the outriggers.

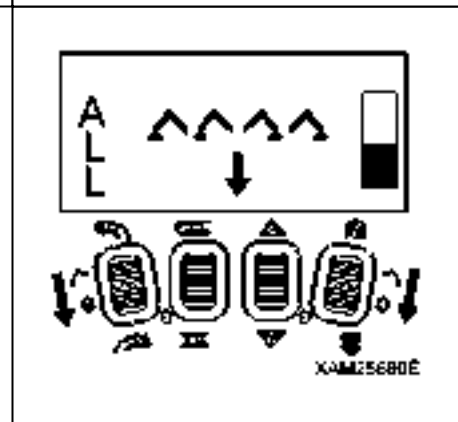

3. Just before outriggers touch the ground, slowly release the acceleration lever, then release the outrigger operation lever to return to its neutral position.

4. Push Speed/Mode button in the mode condition of above 3. The operation mode is switched to “Outrigger individual setting mode”.

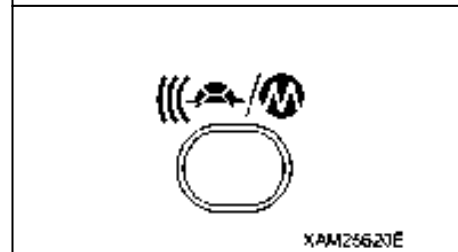

5. Turn one of the outrigger operation levers to “Extend (lower)” and pull the Accelerator lever slowly.

NOTES

Repeat the same process to the other three outriggers and contact all the four outriggers to the ground.

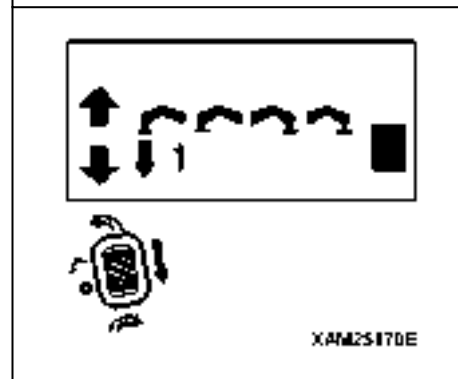

6. Push Speed/Mode button in the mode condition of above 5. The operation mode is switched to “Outrigger collective setting mode”.



7. Move one of the outrigger operation levers to “Extend (lower)” and pull the Accelerator lever slowly.

NOTES

In Outrigger collective setting mode (ALL), operation of any of control levers controls all the outriggers.

8. When the Crane is elevated “approximately 50mm”, slowly release the Accelerator lever, then release the outrigger operation lever to return to the neutral position.

9. Use the level gauge on the machine body and check the levelness of the machine.

When the machine is not level, push Speed/Mode button in the mode condition to switch to "Outrigger individual setting mode" and control each outrigger individually so that the machine is set level.

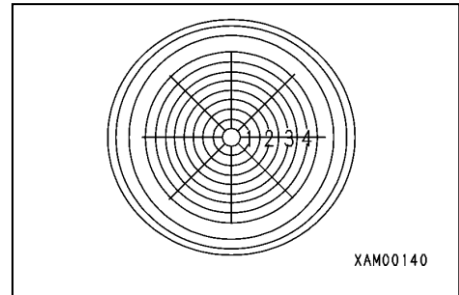
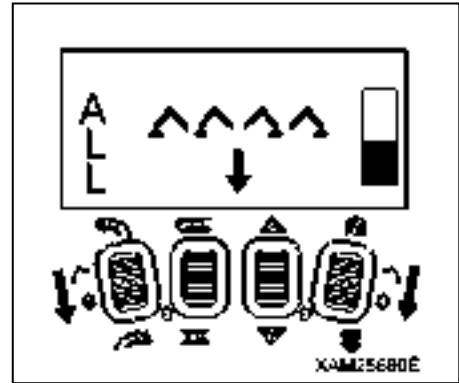

CAUTION

To change from "OUTRIGGER MODE" to "CRANE MODE", turn OFF the power using the Power switch and turn it ON again. Then the mode is automatically set to "CRANE MODE".

8.2.2 OUTRIGGER STOWING

[1] OUTRIGGER COLLECTIVE SETTING

1. In accordance with “REMOTE CONTROL 6.2 Procedure in the Operation Mode”, enter into the “Outrigger collective setting mode”.

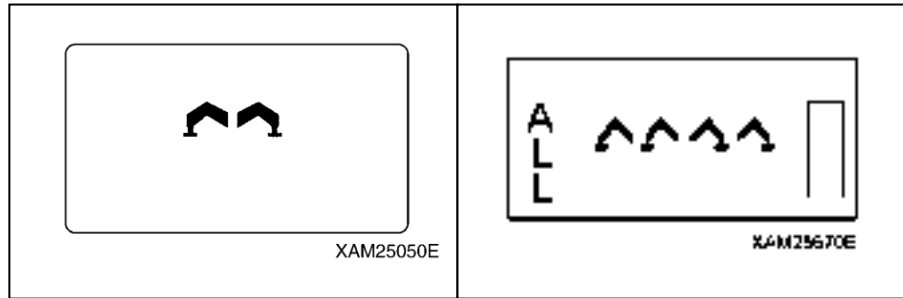

2. Turn one of the outrigger operation levers to “Retract (upper)” and pull the Accelerator lever slowly.

NOTES
In Outrigger collective setting mode (ALL), operation of any of the control levers controls all the outriggers.

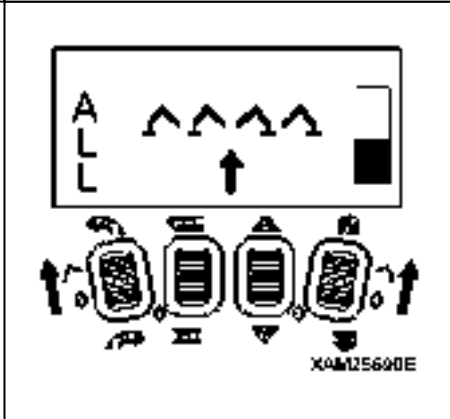

3. When the Crane touches the ground, slowly release the acceleration lever, then release the outrigger operation lever to return to its neutral position.

[2] OUTRIGGER INDIVIDUAL SETTING

1. Push Speed/Mode button in the mode condition of above 1.
The operation mode is switched to “Outrigger individual setting mode”.

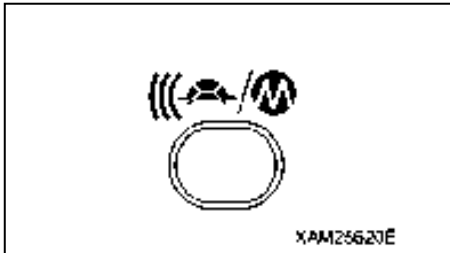

2. Move one of the outrigger operation levers to “Retract (upper)” and pull the Accelerator lever slowly.
3. If the outrigger operation stops, slowly release the acceleration lever, then release the outrigger operation lever to return to its neutral position.

NOTES
<ul style="list-style-type: none"> • Repeat the same process to the other three outriggers and lower all the four outriggers equally and gradually, so that the Crane is grounded. • After the Crane is grounded, lower all the four outriggers completely.

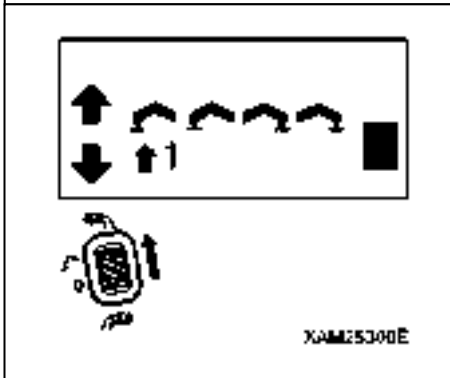

CAUTION

To change from "OUTRIGGER MODE" to “CRANE MODE”, turn OFF the power using the Power switch and turn it ON again. Then the mode is automatically set to “CRANE MODE”.

8.3 OPERATION IN CRANE MODE

⚠ WARNING

- Ensure that all the outriggers are properly installed. Where outriggers are improperly installed, it may result a serious hazard, such as the Crane tipping.
- During crane operations, always refer to the portable rated total load chart and avoid over-loaded operations. Operations in over-loaded conditions may damage or tip the Crane, which may result in a serious hazard.
- Check for smooth and correct actions of each operation lever of the Transmitter, and that they smoothly return to the neutral position when the finger is released.
- Each operation lever of the Transmitter will be blocked by its stopper when it is moved fully. When it is blocked, do not attempt to push further, otherwise it may damage the Transmitter and cause a fault; and may result in a serious accident.
- To toggle each operation lever to the opposite side, or to use another lever, always release the Accelerator lever, each time. Also, to operate the Crane, manipulate the operation lever first, then pull the Acceleration lever next. To stop the operation of the Crane, release your finger from the Accelerator lever, first, and next release the operation lever.
- Always actuate the Accelerator lever with caution to the acceleration rate. It must be properly controlled to keep the appropriate crane operation speed and avoid any abrupt motion. Any abrupt acceleration or deceleration especially while a load is hung will make a large impact to the Crane and may result a serious hazard such as Crane tipping or damage.
- Whilst a load is hung, do not attempt to perform multiple operation. Such as, hook raising and the boom derricking, for instance. That may cause an abrupt change of the load condition and cause a serious hazard such as the Crane tipping or damage.

1. Ensure that the main switch of the Receiver is in the OFF position.
2. Start the engine at the Starter switch of the Crane.

CAUTION

- Prior to starting the engine, perform the following practices on the Crane.
1. Set the Acceleration Lever to the medium speed (about middle of its stroke).
 2. Pull out the choke knob.
 3. Return the choke knob to its initial position, when the engine starts.

3. Then turn ON the Main switch of the Receiver.

NOTES

When the main switch of the Receiver is turned ON, the abnormal signal detector circuit works for 3 to 4 seconds. During this time, the Crane is not ready for operation.

4. Push the Power switch of the Transmitter to power ON. Confirm that the LCD screen shows the mark as the figure on the right and the "CRANE MODE" is automatically provided.

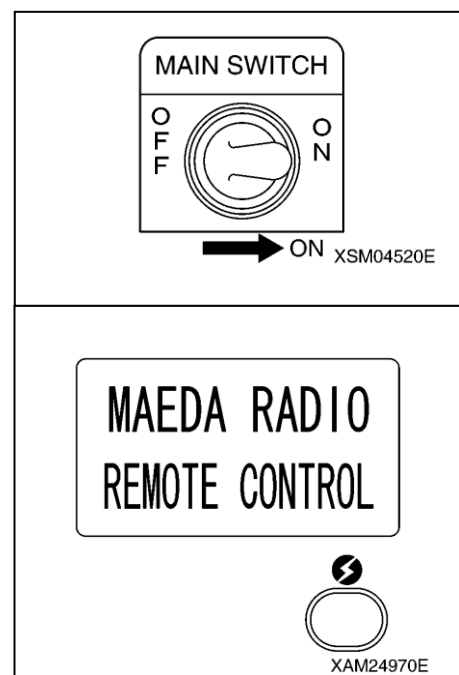

5. In accordance with “REMOTE CONTROL 6.2 Procedure in the Operation Mode”, enter into the “CRANE MODE”.

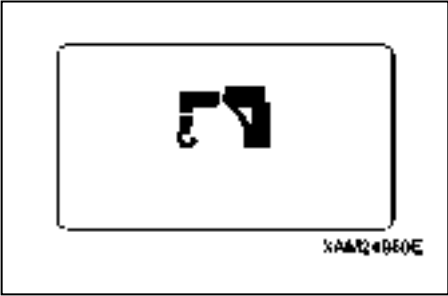

8.3.1 SLEWING OPERATION

⚠ WARNING

For the slewing operation, actuate the Accelerator lever carefully and always keep in low speed. Also, actuate the Accelerator lever slowly and delicately to avoid abrupt slewing. Any abrupt acceleration or deceleration, especially while a load is hung will make a large impact to the Crane and may result in a serious hazard such as Crane tipping or damage.

[1] SLEW CLOCKWISE

Push the Slewing/No.1 outrigger operation lever to “Clockwise (lower)”, then pull the Accelerator lever slowly.

The boom slews clockwise, looking down at the Crane from the sky.

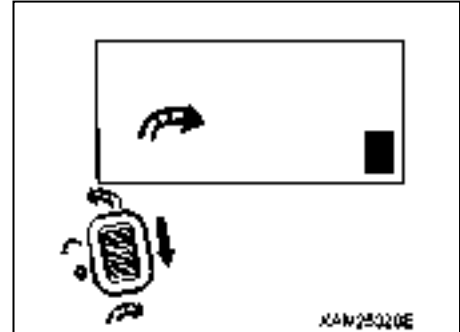

[2] SLEW COUNTERCLOCKWISE

Push the Slewing/No.1 outrigger operation lever to “Counter clockwise (upper)”, then pull the Accelerator lever slowly.

The boom slews counterclockwise, looking down at the Crane from the sky.

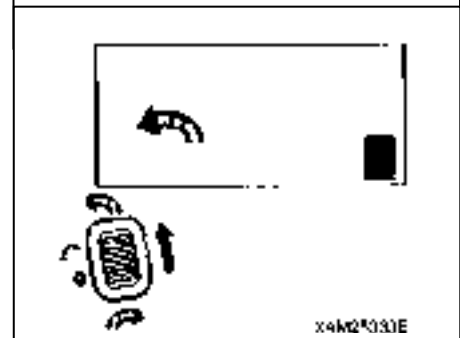

[3] STOP SLEWING

Release the Accelerator lever slowly, then release the Slewing/No.1 outrigger operation lever to return it to its neutral position.

The boom stops slewing.

8.3.2 BOOM TELESCOPING

[1] BOOM “EXTENDING”

Push the Boom telescoping/No.2 outrigger operation lever to “Extend (upper)”, then pull the Accelerator lever slowly.

The boom extends.

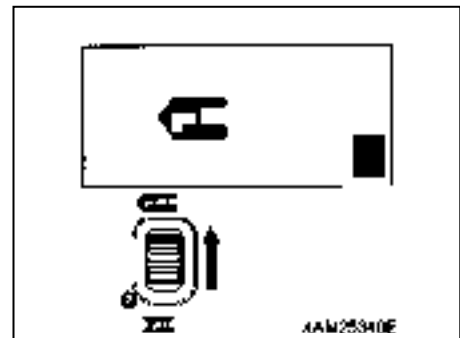

[2] BOOM “RETRACTING”

Push the Boom telescoping/No.2 outrigger operation lever to “Retract (lower)”, then pull the Accelerator lever slowly.

The boom retracts.

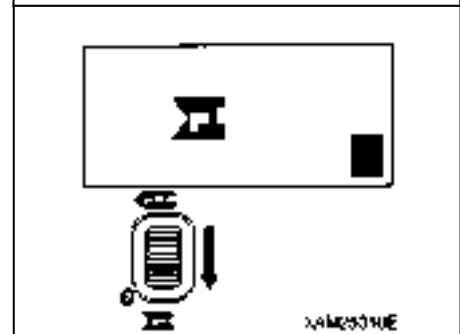

[3] STOP TELESCOPING

Release the Accelerator lever slowly, then next release the Boom telescoping/No.2 outrigger operation lever to return it to the neutral position.

The boom stops telescoping.

8.3.3 HOOK RAISING AND LOWERING

⚠ WARNING

- In the event of “Over-hoist alarming” or “Automatic cut out” during the hook raising operation, immediately stop winding. Otherwise, it may cause damage to the Crane, or a broken wire-rope which will result in dropping of the hook or load; and a serious accident may happen.
 - Continuing hook lowering in the condition that the load has already reached the ground, will cause random winding of the wire-rope. This may damage the wire rope or shorten its life badly. Further, there is some risk that the wire-rope may tangle itself which prevents any more winching. During the hook lowering, always take good care not to cause such random winding.
 - The hook is also raised or lowered by boom telescoping or derricking.
- The same attention must be paid to the hook raising and lowering as in the winching operation.

[1] HOOK RAISING

Push the Hook raising and lowering/No.2 outrigger operation lever to “Raise (upper)”, then pull the Accelerator lever slowly.

The hook starts to rise.

[2] HOOK LOWERING

Push the Hook raising and lowering/No.2 outrigger operation lever to “Lower (lower)”, then pull the Accelerator lever slowly.

The hook starts to lower.

[3] STOP RAISING OR LOWERING

Release the Accelerator lever slowly, then release Hook raising and lowering/No.2 outrigger operation lever to return it to the neutral position.

The hook stops raising or lowering.

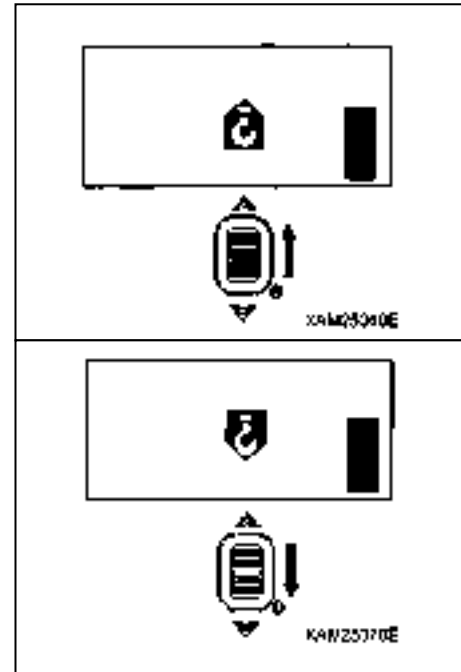

8.3.4 BOOM DERRICKING

[1] BOOM RAISING

Push the Boom derricking/No.4 outrigger operation lever to “Raise (upper)”, then pull the Accelerator lever slowly.

The boom will rise.

[2] BOOM LOWERING

Push the Boom derricking/No.4 outrigger operation lever to “Lower (lower)”, then pull the Accelerator lever slowly.

The boom will lower.

[3] STOP BOOM DERRICKING

Release the Accelerator lever slowly, then release the Boom derricking/No.4 outrigger operation lever to return it to the neutral position.

The boom stops derricking.

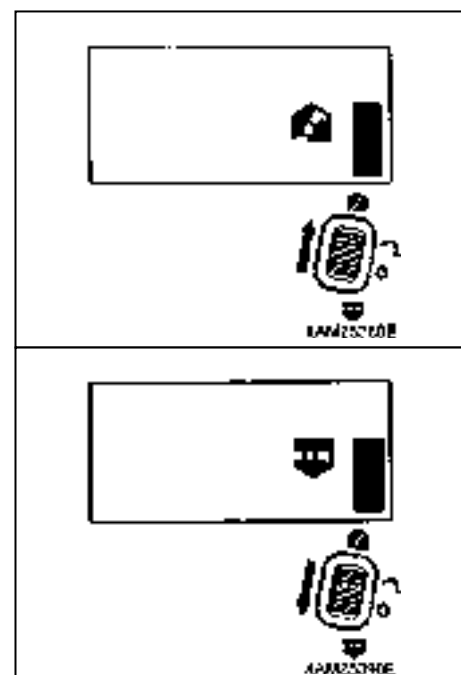

8.3.5 SET-UP AND CANCEL MICRO SPEED

When it is required to operate the Crane in low speed, use the Micro speed mode, which limits the maximum speed of the Crane and facilitates the smoother control in the low speed range.

This machine offers 2 modes for limiting the maximum speed of the Crane. One is the "MICRO SPEED MODE" and the other is the "USER MICRO SPEED MODE", which the user can select their own setting.

"MICRO SPEED MODE" is available by user selection.

NOTES

"MICRO SPEED MODE" is valid only in the "CRANE MODE".

[1] SETTING THE MICRO SPEED MODE

Push the Speed/Mode button.

Each push will forward the LCD screen indication as shown in the diagram, below:

When the indicated mode fits your requirement, carry on the Crane operation in that condition.



[2] CANCEL THE MICRO SPEED MODE

Push the Speed/Mode button several times, until LCD screen indication attains the "Normal".

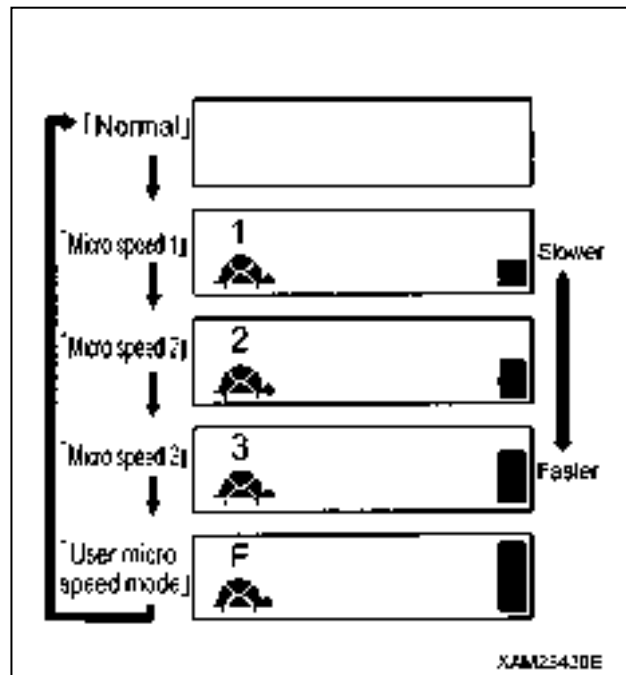

[3] SETTING TO THE USER MICRO SPEED MODE

WARNING

Setting to the User micro speed mode requires actual crane operations with the engine running. Before starting the User micro speed mode setting, always ensure that nobody other than those involved with the operation are within the working area.

1. Push the Speed/Mode button several times so that the LCD screen indicates the "USER MICRO SPEED MODE".

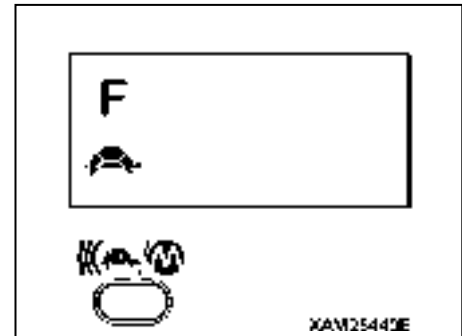

2. Push the Setting button for at least 2 seconds.

Indication of "F" in the LCD screen is high-lighted and it enters into the "USER MICRO SPEED MODE" setting screen.

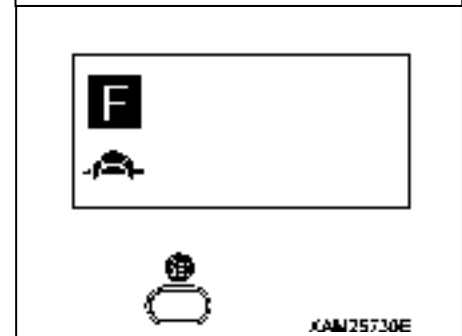

NOTES

The "USER MICRO SPEED MODE" setting is available while the "F" in the LCD screen is high-lighted.

3. Push the operation lever to be adjusted and pull the Accelerator lever slowly.

When the operation speed reaches the desired maximum speed, push the Setting button.

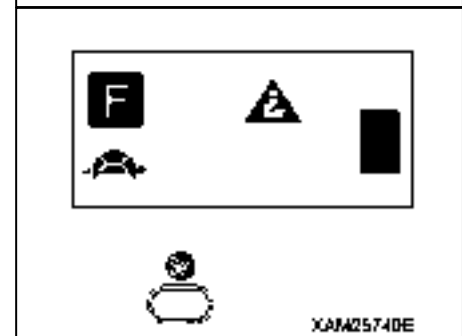

NOTES

Please understand that in the "USER MICRO SPEED MODE", when you set two or more control levers at the same time and pull the Accelerator lever, the crane operation speed follows the operation which is set to the fastest operation

4. When the settings for all the required operation levers are complete push the Speed/Mode button. Now the setting is established and the Micro speed mode is available.

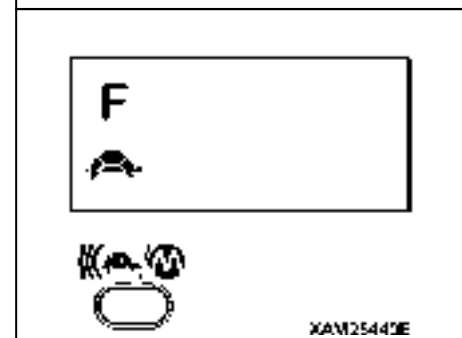

8.3.6 ENGINE STOP AND EMERGENCY STOP PROCEDURE

⚠ WARNING

- For any abnormalities in crane operations, immediately push the Stop/EMO button to stop the engine. This includes such cases as, crane operation does not stop even though you release your fingers from any of the operation levers or Accelerator lever, or the Crane starts any operation even though no operation lever is manipulated.
- In the event of an emergency stop of the engine, turn OFF the power of the Transmitter and check the cause of the emergency, after the engine stops, and repair the failure.
- The Stop/EMO button is also able to stop the engine in normal conditions.

Push the Stop/EMO button to stop the engine from the Transmitter or in case of emergency.

The engine stops.

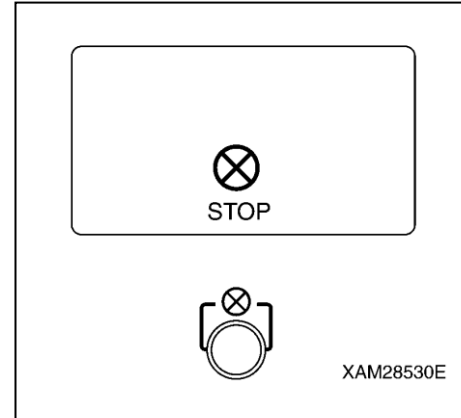

8.3.7 ENGINE START AND RESET PROCEDURE

[1] ENGINE START PROCEDURE

CAUTION

- Follow the procedure below for use of the Start/Reset Button to start the engine:
 1. Position the Starter switch of the Crane to ON.
 2. Set the travelling stand of the Crane to CRANE position.If the Starter switch of the Crane is in OFF position or if the travelling stand of the Crane is in TRAVELLING position, you can not start the engine.
- Prior to starting the engine, perform the following practices on the Crane.
 1. Set the Acceleration Lever to the medium speed (about middle of its stroke).
 2. Pull out the choke knob.
 3. Return the choke knob to its initial position, when the engine starts.

When it is required to start the engine from the Transmitter, push the Start/Reset button. The engine starts.

[2] RESET PROCEDURE

To release the emergency stop equipment or abnormal signal detector, push the Start/Reset button.

Power of the Receiver will be reset.

NOTES

- While the engine runs, the engine starter will not work even though the Start/Reset button is used.
- When the Start/Reset button is used, firstly push the Power switch of the Transmitter to turn it ON.
- When the Start/Reset button is pushed, the abnormal signal detector circuit starts working. Wait for 3 to 4 seconds until it completes.

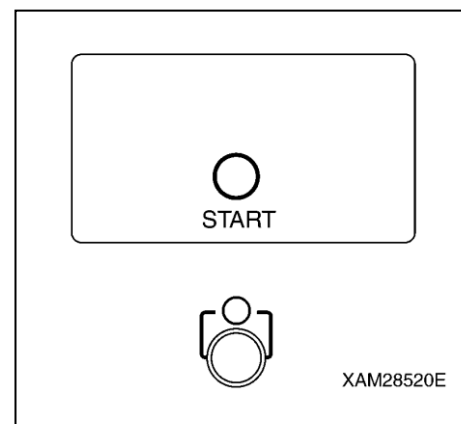

8.4 CHECKING AFTER CRANE OPERATION

WARNING

- When the operation of the Crane is finished, always turn OFF the Transmitter and Receiver power.
- On no occasion except for Crane operations, must the power of the Transmitter be turned ON. That could cause an un-expected motion of the Crane and result in a serious hazard, such that the Crane hitting someone or an object, or the Crane could tip.
- When it is required to turn ON the Transmitter for the purpose of inspection or such, ensure first that the engine is not running, then shut down the Receiver by turning OFF its main switch.

1. Enter into the “CRANE MODE” of the Transmitter operation mode.
2. Use the operation levers and retract the boom to its shortest condition and lower it to the base position.

NOTES

Stowing the hook block is available only by using the control lever and switch on the crane.

3. Enter into the “OUTRIGGER MODE” of the Transmitter operation mode.
4. Use the operation levers and stow all the outriggers so that the Crane is configured to the travelling position.
5. Stop the engine and turn OFF the Transmitter power.
6. Shut down the power of the Receiver by turning its Main switch to the OFF position.
7. Maintain the Transmitter and Receiver as follows:
 - (1) Check operation levers and the Accelerator lever for any faults.
 - (2) Remove oil or other soil by a clean cloth.
 - (3) Repair all the cracks or damages without fail.
8. Put the transmitter into the accessory storage case and keep it in the dry and cool place where the wind and rain or direct sun light is sheltered.

9. TROUBLE SHOOTING

9.1 BEFORE TROUBLE SHOOTING

“While Crane operates perfectly under manual control, part or whole functions are un-operable from the remote control.”

In the event of failure as above, perform the DIAGNOSIS shown in the following pages.

CAUTION

First, check in accordance with the table below before you start the diagnosis, based on the following pages.

Such an error may be occasionally fixed by simple practice, such as applying another operation procedure.

Where checking using the table below and diagnosis in accordance with the process in the following pages fail to fix the errors or faults, contact us or our agents for services.

Check Points	Cause and Action
The Crane is operable under the manual control from the Crane.	When the Crane operates, this remote control device has a failure. Otherwise, when the Crane does not operate, perform the diagnosis of the Crane, itself.
Power of the Transmitter and Receiver is ON.	If not, turn ON the power.
The fuse in the Receiver is blown.	Check whether the fuse is blown or not; check the cause when blown, then replace with a new one.
The Transmitter enclosure is deformed or damaged.	Where the Transmitter enclosure is deformed or damaged, repair or replace it.
Each operation lever of the Transmitter is in its neutral position. The Accelerator lever is completely returned.	In any event of operation levers or control button failure, repair or replace.
Manipulation began just after the Power switch of the Transmitter is turned ON.	Allow 3 to 4 seconds after the Transmitter power is turned ON, with no operations.
The LCD screen in the Transmitter or the Monitor display in the Receiver shows error messages or error codes.	In the event where the error messages or error codes are indicated, first power OFF the Transmitter and turn it ON again.

9.2 ERRORS IN THE REMOTE CONTROL DEVICES.

- For the error diagnosis, always verify the indications in the Monitor display in the Receiver and the LCD screen in the Transmitter. Then find the suitable error display description in the table below so that the cause is presumed, then, follow the recommended remedy for it.
- First, perform the “Remedy 1” in the table, then continue the “Remedy 2” where the error is not yet fixed..
- Remedies marked with ★ You must contact us or our service agents.
- When any other causes are suspected, other than listed below, contact us or our service agents.

Error display		Main cause	Remedy	
Transmitter	Receiver		Remedy 1	Remedy 2
—	—	Receiver printed circuit board (PCB) input voltage dropped. • Relay PCB defective. • Power line wire harness defective between relay PCB and Receiver PCB.	★ Maintenance/replace for Receiver printed circuit board (PCB) or internal wiring	
		Receiver PCB defective	★ Maintenance/replace for Receiver printed circuit board (PCB)	
STOP		The Transmitter is in emergency stop	• Use the Reset button to release the emergency stop.	★ Maintenance/replace for Receiver and Transmitter
—		The Transmitter defective • The Transmitter power is not ON. • The Transmitter PCB defective. • Wire cut in the Connection cable.	• Power ON again the Transmitter ★ Maintenance/replace for Transmitter ★ Maintenance/replace for Transmitter	★ Maintenance/replace for Transmitter
		The Receiver defective. • The Receiver PCB defective. • Wiring problem in the Receiver	★ Maintenance/replace for Transmitter	
E3		The Transmitter defective • Wire cut within accelerator section in the Transmitter, or potentiometer failure.	★ Maintenance/replace for Transmitter	
—		The Transmitter defective • The potentiometer for accelerator lever in the transmitter failed during receiving signal. • A control lever switch in the transmitter failed during receiving signal.	★ Maintenance/replace for Transmitter	
—		The Receiver PCB defective • Data error in the memory.	• Power on the Receiver, again.	★ Maintenance/replace for Receiver
E6		The Transmitter defective • Data error in the memory.	• Power on the Transmitter, again.	★ Maintenance/replace for Transmitter
E4		The Receiver defective • Accelerator Lever of the Transmitter was pulled when the power is turned ON.	• Release the Accelerator Lever and push Start/Reset Button.	★ Maintenance/replace for Transmitter
E9		The Transmitter defective • Any control lever in the Transmitter was not return to neutral position when the power is turned ON.	• Release the Control Lever and push Start/Reset Button.	★ Maintenance/replace for Transmitter

Error display		Main cause	Remedy	
Transmitter	Receiver		Remedy 1	Remedy 2
The Crane operates perfectly under the manual mode but some functions are not available in the remote control mode.		<ul style="list-style-type: none"> • The Receiver PCB defective. • Wiring failure between the Receiver PCB and the control valve solenoids. • Electromagnetic proportional control reducing valve error. 	<ul style="list-style-type: none"> ★ Maintenance/replace for Receiver PCB ★ Maintenance/replace for wiring between the Receiver PCB and the control valve solenoids 	<ul style="list-style-type: none"> ★ Maintenance/replace for Electromagnetic proportional control reducing valve

10. SYSTEM SPECIFICATIONS

Items		MCT300N	
Waterproof protection		IP65	
System configuration		Manual and Remote control, both-way	
Operation monitor		LCD monitor panel • Operation status monitor • Message • Error code	
Safety devices		Emergency stop equipment	
		Abnormal signal detector unit at the engine start	
		Automatic power cut unit (Automatic Power-OFF)	
		Voltage drop limiter	
		Warning switch	
Receiver unit voltage		Power for the Crane (DC 12V)	
Receiver unit power consumption		Approximately 70 watts (maximum, per single function)	
Operating ambient temperature		-10°C to +60°C	
Storage ambient temperature		-20°C to +70°C	
Transmitter weight		600g	
Transmitter functions	Lever switches	Boom raise/lower	Raising and lowering
		Hook raise/lower	Raising and lowering
		Boom telescoping	Extending and retracting
		Slewing	Counterclockwise/clockwise
	Push button switches	Power	ON/OFF
		Horn	Warning signal
		Setting	Mode setting
		Speed/Mode	Speed control/Mode selection
		Start/Reset	Engine start/Reset
		Stop/EMO	Engine stop/Emergency stop
	Trigger type accelerator	Hydraulic control + Engine control	



Daily Pre-Use Checklist

Maeda Mini Crane

Northern (Head Office) Tel: +44 (0)1482 227333

Central Tel: +44 (0)1302 341659

Western Tel: +44 (0)1384 900388

Southern Tel: +44 (0)203 174 0658

www.hird.co.uk

Machine Model: Maeda MC174		Site Name:
Date Week Commencing:	Fleet No:	Address:
Inspected by:		

Daily Pre-use Checks

		M	T	W	T	F	S	S	COMMENTS
1	Are all operators manuals present and readable								
2	Is the Report of Thorough Examination (LOLER) in date								
3	Complete a visual walk around / Inspection for any noticeable defects								
4	Are all safety information decals present and readable								

Check the following components or areas for damage, or missing parts & unauthorised modifications:

5	Fuel Level								
6	Engine oil Level								
7	Hydraulic oil level								
8	Gauges and switches								
9	Electrical components, wiring, connectors,								
10	Hydraulic hoses								
11	Nut, bolts & other fasteners								
12	Tracks								
13	Outriggers								
14	Outrigger Pads								
15	Winch Cable serviceable								
16	Horn								
17	Audible / Visual warnings (Alarms & Beacons)								
18	Controls, Buttons, Joysticks, Remote Control								
19	Boom sections free from defects or debris								
20	Fly Jib free from defects (where applicable)								
21	Hook in serviceable condition								
22	SLI unit operational								
23	Drive function test								
24	Crane function test								
25	Emergency Stop button(s) function								
26	Carry out full function test								

Is the machine safe to use? (please circle)	YES	YES	YES	YES	YES	YES	YES
	NO	NO	NO	NO	NO	NO	NO

Operator's Initials							
----------------------------	--	--	--	--	--	--	--

Result of Inspections: List defects or state "No Defects"

Signature:	Name:	Date:
-------------------	--------------	--------------