

Manitex



TC400

40-ton (36,3 mt) TELESCOPIC CRANE
TC400 SERIES PRODUCT GUIDE

CONTENTS

Crane Features	4
TC400 Chassis Data - S Models	5
TC400 Chassis Data - SHL Models	6
Outrigger Extension.....	7
Sub Frame	7
Electrical System	7
4077S Load Chart: Main Boom.....	8
4077S Boom Diagram	9
4077SHL Load Chart: Main Boom.....	10
4077SHL Boom Diagram	11
40100S Load Chart: Main Boom and Jib.....	12
40100S Boom Diagram	13
40100SHL Load Chart: Main Boom and Jib.....	14
40100 SHL Boom Diagram	15
40124S Load Chart: Main Boom and Jib.....	16
40124S Boom Diagram	17
40124SHL Load Chart: Main Boom and Jib.....	18
40124SHL Boom Diagram	19
Area of Operation.....	20
Reeving Diagram.....	20
LMI Codes	21
Warning, Information & Definitions	21
Technical Descriptions	22-23
Options	23

Effective Date: September 1, 2013

This document is non-contractual. This document is supplied for reference use only. We are constantly making improvements to our products and reserve the right that specification, equipment, and prices are all subject to change without notice or obligation.

The photographs, and/or images in this document are for illustrative purposes only and may include optional equipment and accessories and may not include all standard equipment. Refer to the appropriate Operator's Manual and Load Chart for instructions on the proper use of this equipment to determine allowable crane lifting capacities, assembly and operating procedures. Failure to follow the appropriate operator's manual or load chart(s) when using our equipment or to otherwise act irresponsibly may result in serious injury or death.



















The only warranty applicable to our equipment is the standard written warranty applicable to the particular production model. Manitex makes no other warranty, expressed or implied. Products and services listed may be trademarks, service marks or trade names of Manitex International and/or its subsidiaries in the USA and other countries.

















All rights are reserved. Manitex® is a registered trademark of Manitex International, Inc. in the USA and many other countries.

Copyright 2013 Manitex Inc., Manitex Inc., Georgetown, Texas, 78626



KEY

	Operator aids
	Cab
	Heating / Air conditioning
	Controls
	Hoist speed
	1 - Main hoist 2 - Auxiliary winch 3 - Recovery winch
	Rope length
	Rope - standard/optional
	Rope diameter
	Permissible line pull
	Maximum line pull
	Slewing / Allowable slewing range
	Slewing gears
	Slewing brake
	Outriggers / Lifting on outriggers
	2-Person man basket
	Counterweight
	Radio remote control

	Hook block
	Distance from hook to head sheave pin
	Hook and ball
	Hydraulics
	Boom elevation angle
	Max. boom length with extension
	Boom with extension retracted
	Boom angle
	Telescoping mode
	Working radius
	Boom length
	Hydraulic actuated boom
	Full power mechanical synchronized
	Boom head / Hook block dimension
	Main boom with auxiliary head
	Tip height



THE TC400 SERIES TELESCOPIC CRANES

Versatile. Affordable. User friendly.

The TC400 series telescopic cranes are built to meet the wide-ranging needs of owner operators who may use it for residential construction one day and bridge work the next. No matter what the task, the 40-ton line of telescopic crane is designed to get you to the job and on the job quickly.

With it, you can:

- Travel to and between job sites at highway speed on a commercial chassis
- Set up quickly with radio outrigger controls
- Operate comfortably and confidently in its tiltable cab

Other features include:

- 40-ton capacity @ 5 ft. radius
- 3, 4 & 5-section proportional boom
- Optional telescopic jib
- 187 ft. maximum tip height (with optional telescopic jib)
- Tiltable cab
- Out-and-down outriggers
- Remote outrigger controls

RADIO OUTRIGGER CONTROLS

Operate the outriggers remotely, with a clear view of the machine, using radio outrigger controls we call ROC Solid.



Operator cab tilts from 0° to 20° for a comfortable, clear view of the load.

TWO-SPEED PLANETARY HOIST

Increase productivity and minimize downtime. The two-speed planetary hoist lets you change line speed on the fly and minimize rope stacking.

REMOTE WINCH CONTROL

Lower and raise the hook block quickly. With remote winch control on the TC400 series, the winch can be operated from any location. (OPTIONAL)

INCREASE PROFITABILITY

The versatile TC400 series is designed to help both owners and operators make the most of their investment.

- Travel to and between jobs at highway speed
- Minimize maintenance costs with replaceable, self-lubricating boom slider pads and sealed, multi-disc wet brakes on the hoist and swing system.
- Minimize repair costs with its front stabilizer and first-up auto retract feature that prevents drive-away damage.



TC400 SERIES CHASSIS DATA: S MODELS

TC400 Series S Dimensions

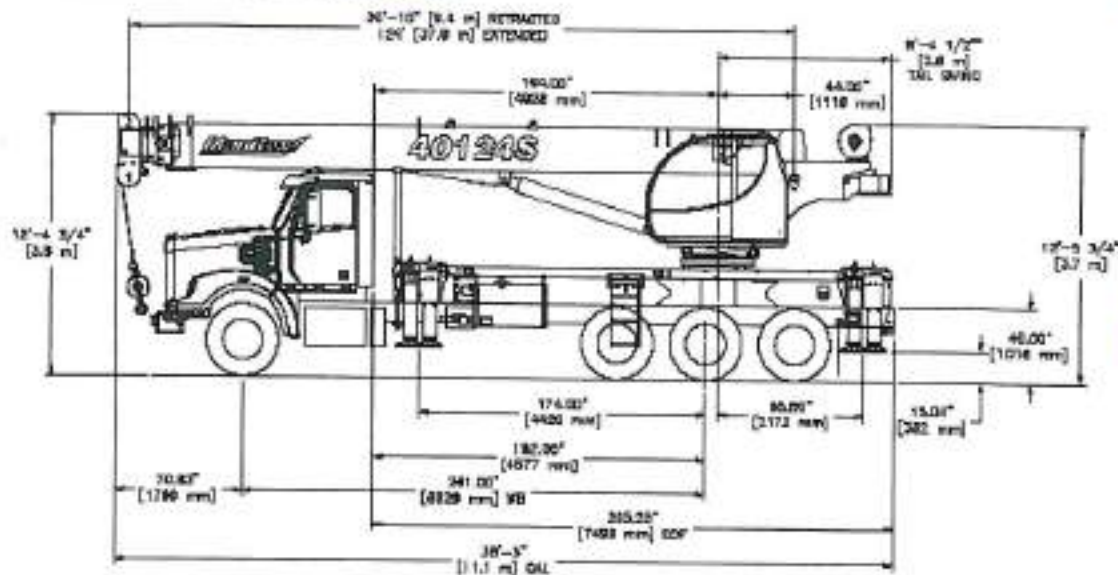

Auxiliary Winch

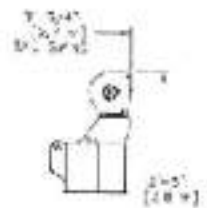

Auxiliary Sheave Head

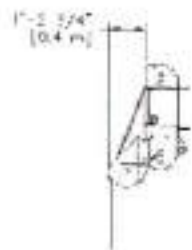

CHASSIS DATA

S Models	
Wheel Base (WB)	261 in. (6,639 mm)
Cab to Tandem (CT)	192 in. (4,877 mm)
Cab to End of Frame (EOF)	295 in. (7,493 mm)
Nominal frame W	34 in. (864 mm)
Frame section modulus at 180/360° area of operation*	25.0 in ³ , 110,000 psi, 758,422 kPa

* Frame section modulus at 360° area of operation requires front bumper stabilizer.

TRUCK AXLE WEIGHTS

Model	4077S	40100S	40124S
Front axle (GW)	18,000 lbs. (8,165 kg)	18,000 lbs. (8,165 kg)	20,000 lbs. (9,072 kg)
Rear axle	40,000 lbs. (18,144 kg)	40,000 lbs. (18,144 kg)	40,000 lbs. (18,144 kg)
Min. truck axle W - Front**	8,000 lbs. (3,629 kg)	8,000 lbs. (3,629 kg)	9,200 lbs. (4,173 kg)
Min. truck axle W - Rear**	8,300 lbs. (3,765 kg)	8,300 lbs. (3,765 kg)	8,300 lbs. (3,765 kg)

** Minimum chassis weight is required to meet 85% stability requirements. Chassis data is general - not for engineering. Some dimensions depend on truck selection.

CRANE WEIGHTS

Model	4077S	40100S	40124S
Crane	28,895 lbs. (13,107 kg)	30,965 lbs. (14,045 kg)	32,385 lbs. (14,690 kg)
Jib fixed	830 lbs. (376 kg)	830 lbs. (376 kg)	830 lbs. (376 kg)
Jib telescopic	1,720 lbs. (780 kg)	1,720 lbs. (780 kg)	1,720 lbs. (780 kg)
Flatbed 8 ft.	825 lbs. (374 kg)	825 lbs. (374 kg)	825 lbs. (374 kg)
Flatbed 10 ft.	1,000 lbs. (454 kg)	1,000 lbs. (454 kg)	1,000 lbs. (454 kg)

Notes: Additional axes required for Federal bridge legal configuration - consult Manitex. Manitex highly recommends the addition of a front stabilizer and it may be required on some installations - consult Manitex.

Data published herein is intended as a guide only. Crane operation is subject to machine specific load charts and information.

TC400 SERIES CHASSIS DATA: SHL MODELS

TC400 Series SHL Dimensions

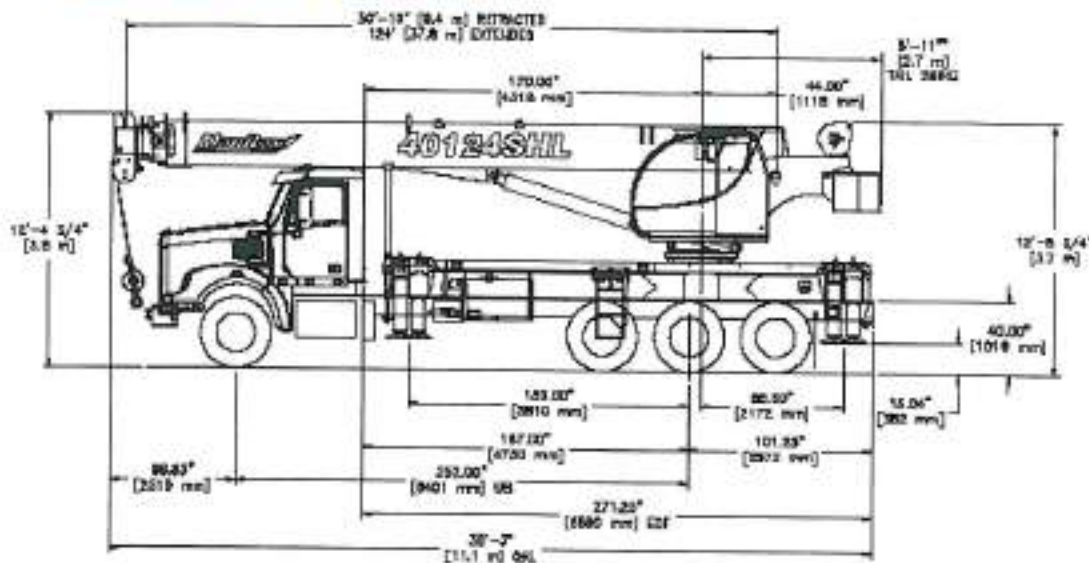

Auxiliary Winch



Auxiliary Sheave Head

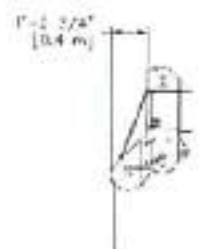

CHASSIS DATA

SHL Models	
Wheel Base (WB)	252 in. (6,401 mm)
Cab to Tandem (CT)	187 in. (4,750 mm)
Cab to End of Frame (EOF)	271 in. (6,883 mm)
Nominal frame length	34 in. (864 mm)
Frame section modulus at 180/360° area of operation*	25.0 in ³ , 110,000 psi 758,422 kPa

* Frame selection models at 360° area of operation requires front bumper stabilizer.

TRUCK AXLE WEIGHT

Model	4077SHL	40100SHL	40124SHL
Front axle (GW)	20,000 lbs. (9,072 kg)	20,000 lbs. (9,072 kg)	20,000 lbs. (9,072 kg)
Rear axle	44,000 lbs. (19,958 kg)	44,000 lbs. (19,958 kg)	44,000 lbs. (19,958 kg)
Min. truck axle weight - Front**	9,800 lbs. (4,445 kg)	9,800 lbs. (4,445 kg)	9,800 lbs. (4,445 kg)
Min. truck axle weight - Rear**	8,000 lbs. (3,629 kg)	8,000 lbs. (3,629 kg)	8,000 lbs. (3,629 kg)

** Minimum chassis weight is required to meet 65% stability requirements. Chassis data is general - not for engineering. Some dimensions depend on truck selection.

CRANE WEIGHTS

Model	4077SHL	40100SHL	40124SHL
Crane	34,995 lbs. (15,873 kg)	37,085 lbs. (16,812 kg)	38,485 lbs. (17,457 kg)
Jib fixed	830 lbs. (376 kg)	830 lbs. (376 kg)	830 lbs. (376 kg)
Jib telescopic	1,720 lbs. (780 kg)	1,720 lbs. (780 kg)	1,720 lbs. (780 kg)
Flatbed 8 ft.	825 lbs. (374 kg)	825 lbs. (374 kg)	825 lbs. (374 kg)
Flatbed 10 ft.	1,000 lbs. (454 kg)	1,000 lbs. (454 kg)	1,000 lbs. (454 kg)

Notes: Additional axles required for federal bridge legal configuration - consult Manitex. Manitex highly recommends the addition of a front stabilizer and it may be required on some installations - consult Manitex.

Data published herein is intended as a guide only. Crane operation is subject to machine specific load charts and information.

OUTRIGGER EXTENSION

Full Extension

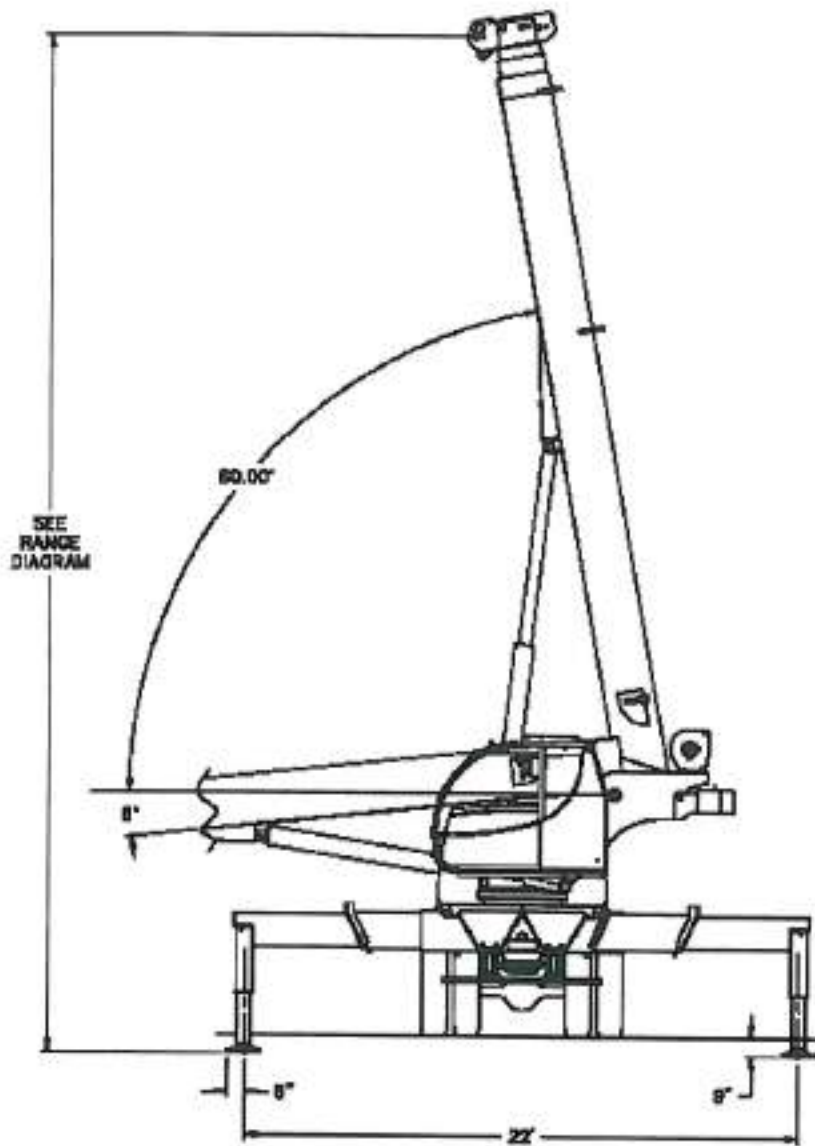

Middle Extension

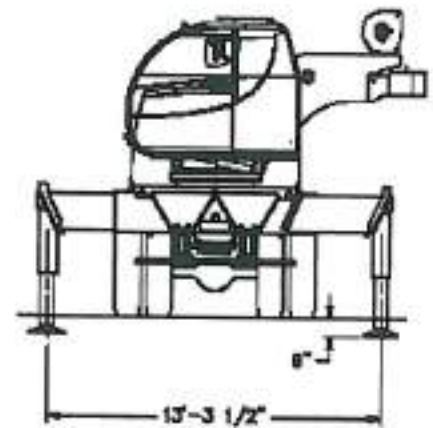

Full Retraction

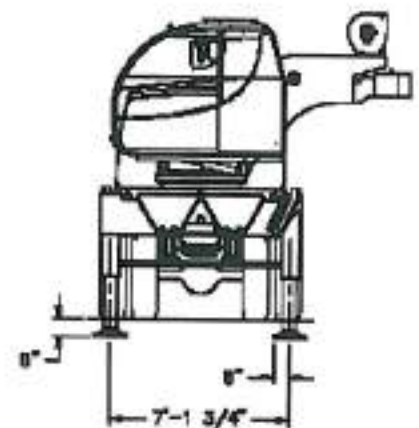

SUB FRAME

- Pedestal sub-frame and stabilizers are mounted to chassis by threaded rods and clamp plates
- Sub-frame: Torsion resistant, rigid 4-plate design mounted under crane full length of truck frame
- Rear under-ride protection: Standard on factory mounted cranes

ELECTRICAL SYSTEM

- State-of-the-art, weather-resistant components throughout
- Hermetically sealed enclosure includes power in relays and circuit status LEDs

Data published herein is intended as a guide only. Crane operation is subject to machine specific load charts and information.

4077S LOAD CHART: Main Boom

Lifting Capacities 3-section Boom 30.5 ft. - 76.8 ft.
Full Outrigger Extension

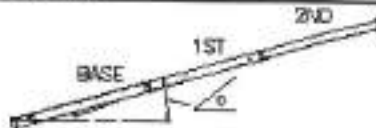

MAIN BOOM LOAD RATINGS IN LBS. WITH OUTRIGGERS PLACED AS SHOWN AND THE CRANE LEVEL

UNICODE #										
 (ft)	Loaded boom Angle (deg)	Boom Length and Major (bs)								
			A		B		C		D	
		30.5 ft.	40 ft.	52 ft.	64 ft.	76.8 ft.				
5	75	80,000								
8	68	61,760	74	55,500	79	47,500				
10	65	53,930	71	50,920	76	47,500	80	38,000		
12	61	48,090	68	45,240	74	42,780	78	35,050	80	28,410
15	54	41,110	64	38,890	71	36,570	75	30,890	78	25,500
20	41	31,330	55	31,330	65	29,690	70	25,850	74	21,670
25	21	22,870	46	23,090	58	23,320	65	21,930	70	19,870
30			34	17,220	51	17,460	60	17,580	66	16,470
35			16	13,420	44	13,690	55	13,810	62	13,890
40					34	10,950	48	11,100	58	11,190
45					22	9,790	42	9,960	53	9,050
50							35	7,360	48	7,480
55							25	6,110	43	6,210
60							7	5,090	36	5,200
65									29	4,420
70									19	3,740



NOTES:

- All loads rated at 360° pick
- Loads based on crane on outriggers
- All "on outriggers" loads are based on 85% tipping
- Loads above heavy line are based on structural rating
- Loads below heavy line are based on tipping rating

Data published herein is intended as a guide only. Crane operation is subject to machine specific load charts and information.



4077S BOOM DIAGRAM

- FULLY EXTENDED OUTRIGGER CONFIGURATION -

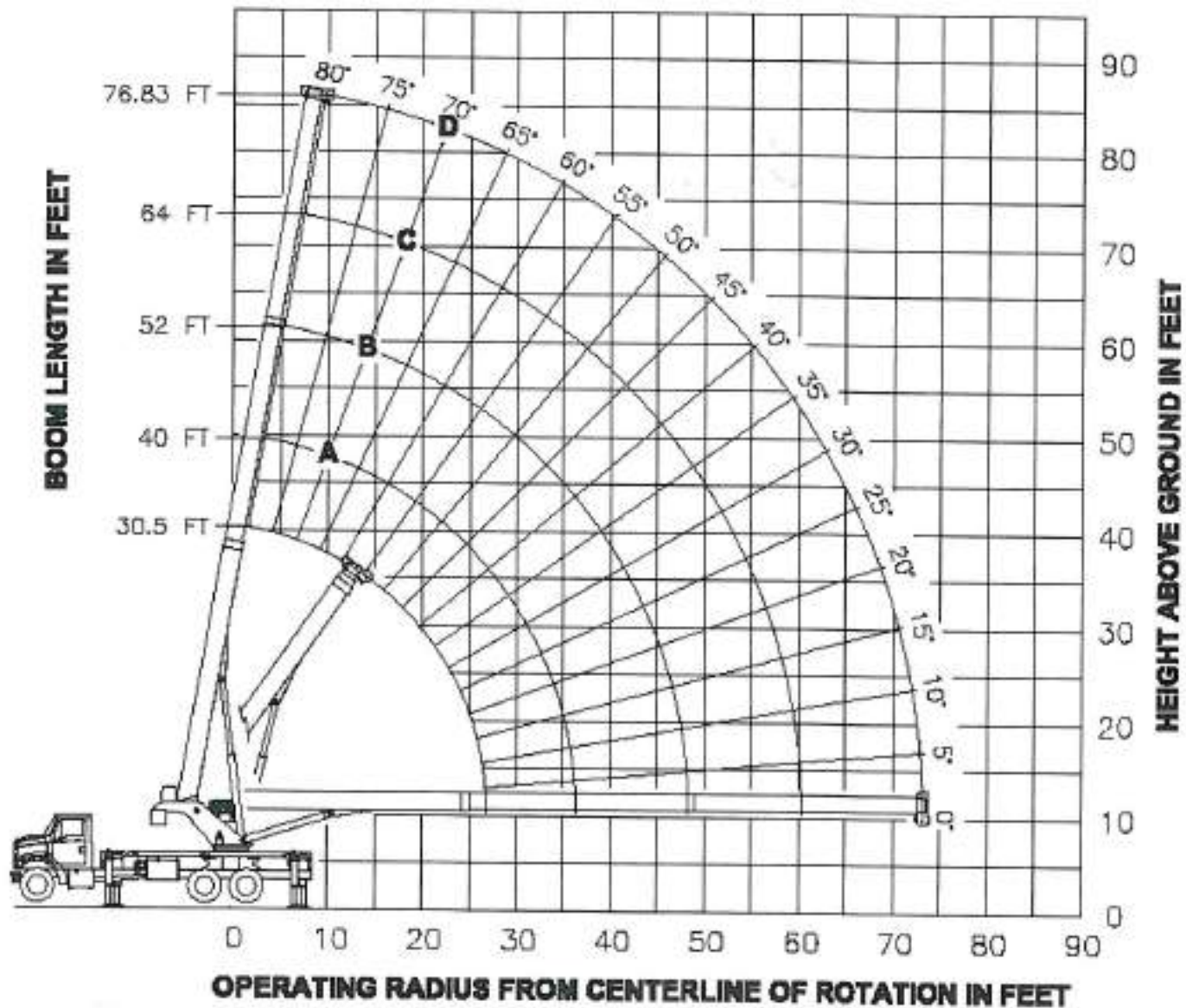

Data published herein is intended as a guide only. Crane operation is subject to machine specific load charts and information.

4077SHL LOAD CHART: Main Boom

Lifting Capacities 3-section Boom 30.5 ft. - 76.8 ft.
Full Outrigger Extension

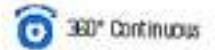

MAIN BOOM LOAD RATINGS IN LBS. WITH OUTRIGGERS PLACED AS SHOWN AND THE CRANE LEVEL

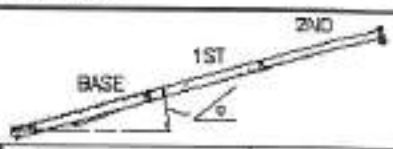
UNICODE #1										
 (ft)	Loaded Boom Angle (deg)	Boom Length and Marker (lbs)								
			A		B		C		D	
		30.5 ft.	40 ft.	52 ft.	64 ft.	76.8 ft.				
5	75	80,000								
8	68	61,760	74	55,500	79	47,500				
10	65	51,930	71	50,920	76	47,500	80	38,000		
12	61	48,890	68	45,240	74	42,780	78	35,050	80	28,410
15	54	41,110	64	38,890	71	36,570	75	30,890	78	25,500
20	41	30,820	55	31,330	65	29,590	70	25,850	74	21,670
25	21	25,700	46	26,330	58	24,780	65	21,930	70	18,870
30			34	20,490	51	20,730	60	18,000	66	16,470
35			16	18,100	44	16,380	55	16,500	62	14,540
40					34	13,340	48	13,470	58	12,930
45					22	11,090	42	11,230	53	11,200
50							35	9,510	48	9,580
55							25	8,140	43	8,230
60							7	7,000	36	7,120
65									29	6,200
70									19	5,430

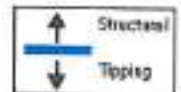

NOTES:

- All loads rated at 360° pick
- Loads based on crane on outriggers
- All "on outriggers" loads are based on 85% tipping
- Loads above heavy line are based on structural rating
- Loads below heavy line are based on tipping rating

Data published herein is intended as a guide only. Crane operation is subject to machine specific load charts and information.



4077SHL BOOM DIAGRAM

- FULLY EXTENDED OUTRIGGER CONFIGURATION -

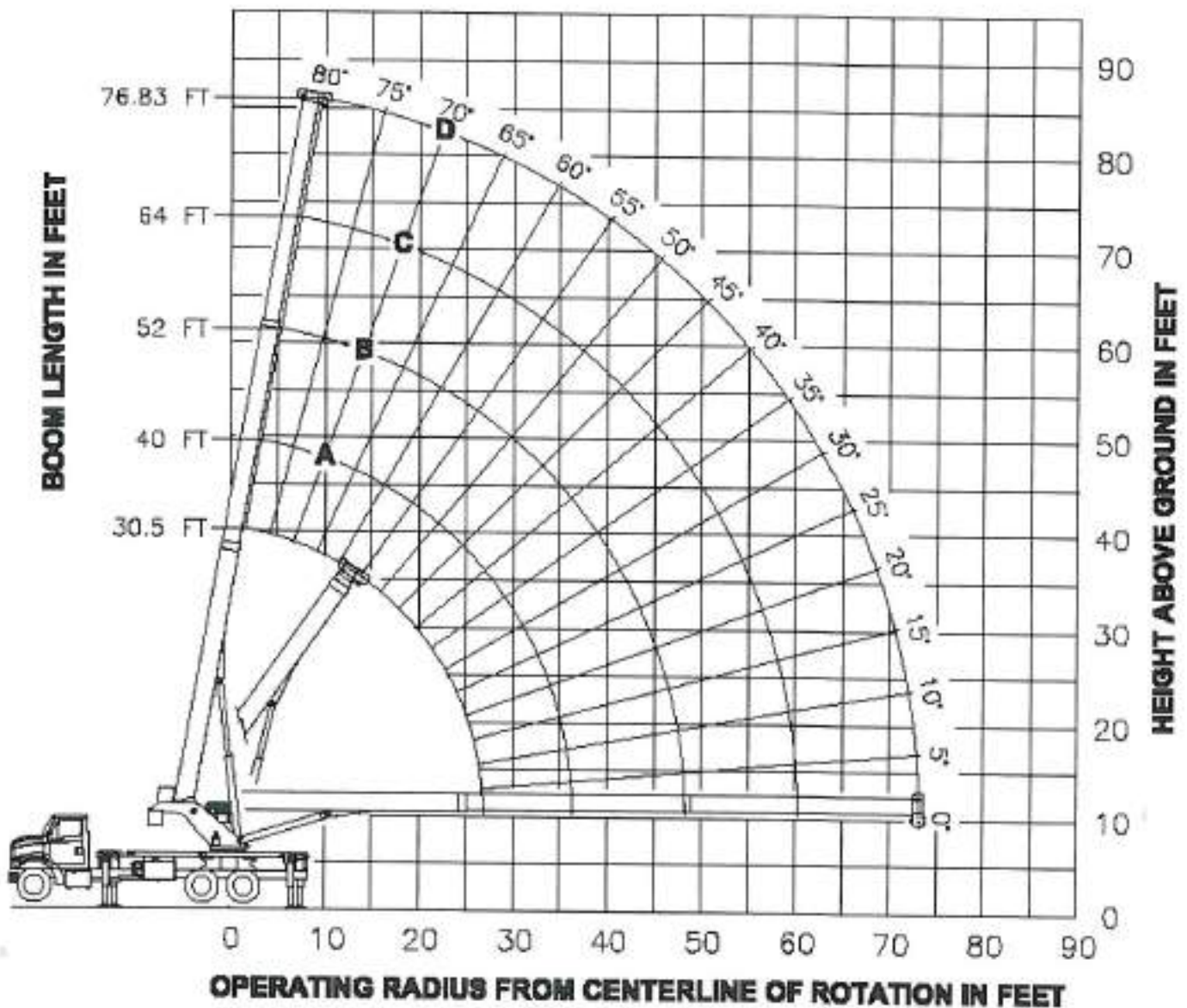

Data published herein is intended as a guide only. Crane operation is subject to machine specific load charts and information.

40100S LOAD CHART: Main Boom and Jib

Lifting Capacities 4-section Boom 30.5 ft. - 100 ft
 1 or 2-section Jib 31 ft. - 55 ft. - Full Outrigger Extension

 22 ft. (100%)

 360° Continuous

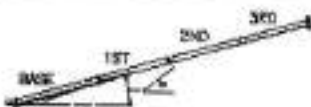
Load Ratings in (lbs.) with Outriggers and Stabilizers Extended										Jib Load Ratings in (lbs.) with Outriggers and Stabilizers Extended									
LMI Code #1										LMI Code #2									
Lifted Boom Angle (ft.)	Boom length & Motor									Lifted Boom Angle (ft.)	Fixed Jib		Telescopic Jib						
		A (bs.)		B (bs.)		C (bs.)		D (bs.)			LMI Code #3	LMI Code #7	LMI Code #10	LMI Code #13					
		30.5 ft.	52 ft.	68 ft.	84 ft.	100 ft.					Jib Length for All Boom Lengths	Jib Length for All Boom Lengths	Jib Length for All Boom Lengths	Jib Length for All Boom Lengths					
5	74	80,000																	
8	68	61,000																	
10	64	52,800	76	31,500						10									
12	60	47,000	73	31,500	78	31,500				12									
15	53	40,280	70	31,500	76	31,500	79	23,700		15									
20	40	30,880	64	28,600	71	26,820	76	20,500	79	14,000	20								
25	20	22,280	58	23,220	67	22,160	72	18,300	76	13,500	25								
30			51	17,220	62	17,450	68	15,870	73	12,820	30	77	7,300	77	7,000				
35			43	13,370	57	13,580	65	13,720	70	11,380	35	75	7,100	75	6,800	78	4,800		
40			34	10,860	52	10,910	61	11,030	67	10,160	40	73	6,620	73	6,240	76	3,850		
45			22	9,440	46	8,710	57	8,950	64	8,940	45	71	6,050	71	5,670	74	3,700		
50					39	7,080	52	7,200	60	7,290	50	68	5,580	68	5,150	73	3,550		
55					32	5,790	48	5,920	57	6,010	55	66	5,100	66	4,680	71	3,210		
60					22	4,760	43	4,910	53	4,990	60	64	4,680	64	4,210	69	3,090		
65							37	4,080	49	4,160	65	61	4,210	61	3,740	67	2,900		
70							31	3,280	45	3,470	70	58	3,600	58	3,230	65	2,710		
75							22	2,800	40	2,890	75	56	3,200	56	2,800	63	2,550		
80							7	2,280	35	2,290	80	53	2,690	53	2,290	61	2,400		
85									30	1,960	85	50	2,250	50	1,850	59	2,270		
90									22	1,580	90	47	1,870	47	1,450	55	2,080		
95									11	1,230	95	43	1,530	43	1,120	54	1,820		
100											100	40	1,230	40	820	52	1,510		
105											105	36	960	36	580	49	1,240		
110											110					46	990		
115											115					43	770		
120											120					40	560		
		990 lbs.	350 lbs.	270 lbs.	220 lbs.	180 lbs.					Fixed Jib		Deductions for Stowed Jib						
		890 lbs.	530 lbs.	400 lbs.	330 lbs.	280 lbs.					Telescopic Jib								

NOTES:

- All loads rated at 360° pick
- Loads based on crane on outriggers
- All "on outriggers" loads are based on 85% tipping
- Loads above heavy line are based on structural rating
- Loads below heavy line are based on tipping rating



Data published herein is intended as a guide only. Crane operation is subject to machine specific load charts and information.



40100S BOOM DIAGRAM

- FULLY EXTENDED OUTRIGGER CONFIGURATION -

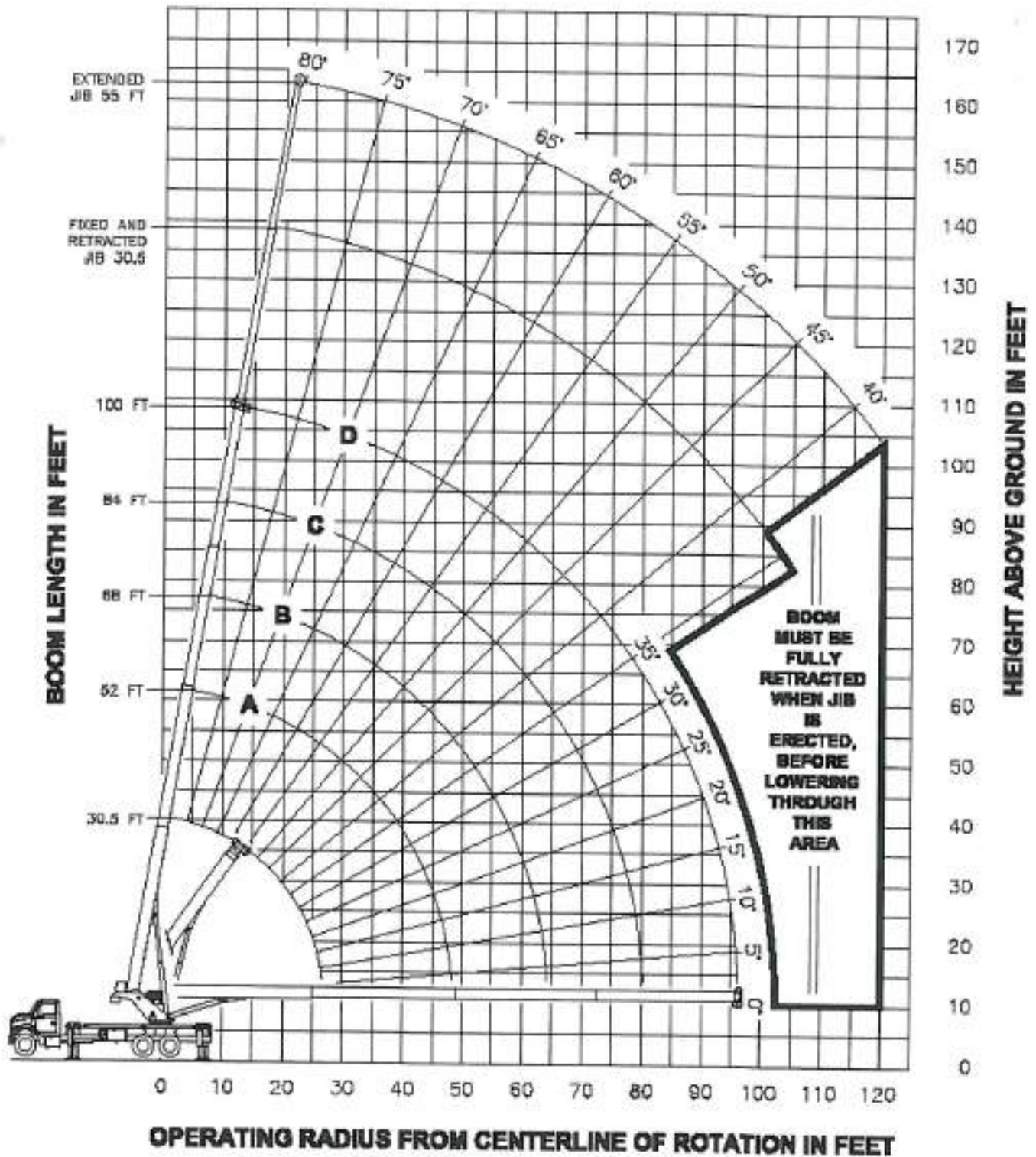

Data published herein is intended as a guide only. Crane operation is subject to machine specific load charts and information.

40100SHL LOAD CHART: Main Boom and Jib

Lifting Capacities 4-section Boom 30.5 ft. - 100 ft.
 1 or 2-section Jib 31 ft. - 55 ft. - Full Outrigger Extension

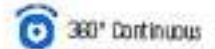

Load Ratings in (lbs.) with Outriggers and Stabilizers Extended										Jib Load Ratings in (lbs.) with Outriggers and Stabilizers Extended						
LMI Code #1										LMI Code #32						
Lifted Boom Angle (ft.)	Boom length & height (ft.)									Lifted Boom Angle (ft.)	Fixed Jib		Telescopic Jib			
		A (lbs.)		B (lbs.)		C (lbs.)		D (lbs.)			LMI Code #32	LMI Code #7	LMI Code #13			
										Loaded Boom Angle	Jib length for All Boom lengths	Loaded Boom Angle	Jib length for All Boom lengths	Loaded Boom Angle	Jib length for All Boom lengths	
5	74	30.5 ft.	52 ft.	68 ft.	84 ft.	100 ft.					30.5 ft.		30.5 ft.		55 ft.	
8	68	61,000														
10	64	52,800	76	31,500						10						
12	60	47,000	73	31,500	79	31,500				12						
15	52	40,200	70	21,500	76	31,500	79	23,700		15						
20	40	31,970	64	29,800	71	26,820	76	20,500	79	14,000	20					
25	20	24,430	58	23,800	67	22,160	72	18,300	76	13,500	25					
30			51	20,400	62	19,080	69	15,070	73	12,520	30	77	7,300	77	7,000	
35			43	15,980	57	18,200	65	13,950	70	11,380	35	75	7,100	75	6,800	
40			34	12,890	52	13,310	61	12,350	67	10,160	40	73	6,620	73	6,240	
45			22	10,610	46	10,840	57	10,960	64	9,370	45	71	6,060	71	5,670	
50					39	9,090	52	9,220	60	8,400	50	69	5,550	69	5,150	
55					32	7,730	49	7,930	57	7,620	55	68	5,100	68	4,690	
60					22	6,590	43	6,710	53	6,790	60	64	4,600	64	4,210	
65							37	5,790	48	5,860	65	61	4,210	61	3,740	
70							31	5,000	45	5,070	70	59	3,800	59	3,320	
75							22	4,320	40	4,410	75	56	3,440	56	2,970	
80							7	3,730	35	3,800	80	53	3,120	53	2,660	
85									30	3,320	85	50	2,840	50	2,370	
90									22	2,980	90	47	2,590	47	2,120	
95									11	2,470	95	43	2,350	43	1,890	
100											100	40	2,150	40	1,690	
105											105	36	1,990	36	1,500	
110											110	32	1,790	32	1,300	
115											115	27	1,500	27	1,080	
120											120	21	1,270	21	850	
125											125	13	1,040	13	630	
		590 lbs.	350 lbs.	270 lbs.	220 lbs.	190 lbs.					Fixed Jib		Deductions for Stowed Jib			
		890 lbs.	530 lbs.	400 lbs.	330 lbs.	280 lbs.					Telescopic Jib					

NOTES:

- All loads rated at 360° pick
- Loads based on crane on outriggers
- All "on outriggers" loads are based on 85% tipping
- Loads above heavy line are based on structural rating
- Loads below heavy line are based on tipping rating



Data published herein is intended as a guide only. Crane operation is subject to machine specific load charts and information.



40100SHL BOOM DIAGRAM

- FULLY EXTENDED OUTRIGGER CONFIGURATION -

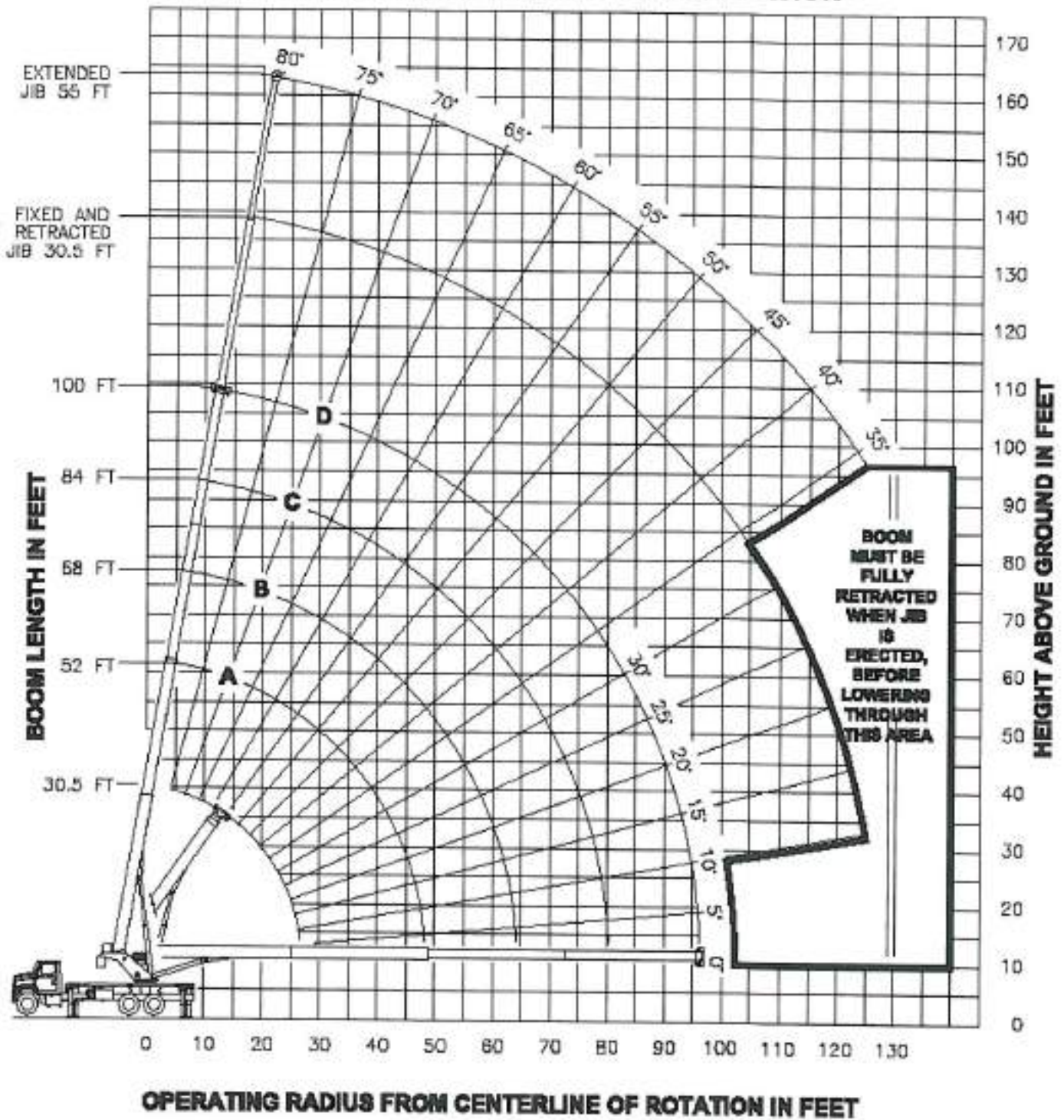











Data published herein is intended as a guide only. Crane operation is subject to machine specific load charts and information.

40124S LOAD CHART: Main Boom and Jib

Lifting Capacities 5-section Boom 30.8 ft. - 123.5 ft.
1 or 2-section Jib 31 ft. - 55 ft. - Full Outrigger Extension

 22 ft. (100%)

 360° Continuous

MAIN BOOM LMI CODE 1																			
(ft.)	30.83 ft.		47 ft. (A)		58 ft. (B)		69 ft. (C)		80 ft. (D)		91 ft. (E)		102 ft. (F)		113 ft. (G)		123.5 ft. (H)		
		Load Capacity (lbs.)		Load Capacity (lbs.)		Load Capacity (lbs.)		Load Capacity (lbs.)		Load Capacity (lbs.)		Load Capacity (lbs.)		Load Capacity (lbs.)		Load Capacity (lbs.)		Load Capacity (lbs.)	
5	75	80,000																	
8	69	60,500																	
10	64	52,500	74	25,000															
12	60	46,500	72	25,000	76	25,000	79	25,000											
15	53	39,500	69	25,000	73	25,000	76	25,000	79	21,500									
20	40	30,500	61	25,000	67	25,000	72	23,500	76	19,700	78	17,100	79	14,500					
25	22	23,070	53	23,750	62	22,860	67	21,680	71	19,200	74	16,950	77	13,500	78	10,910	80	8,450	
30			45	18,430	56	18,670	63	18,720	67	16,250	71	14,530	74	12,020	76	10,430	79	8,150	
35			36	14,200	49	14,450	58	14,600	63	14,540	68	12,960	71	11,200	73	9,560	75	7,800	
40			22	10,880	42	11,150	52	11,370	59	11,490	64	11,570	68	10,150	71	8,680	73	7,280	
45					34	8,820	47	9,000	55	9,130	60	9,190	65	8,250	68	7,040	71	6,700	
50					23	7,030	40	7,230	50	7,360	56	7,420	61	7,680	65	7,260	68	6,160	
55							34	5,850	45	5,970	52	6,050	58	6,110	62	6,150	65	5,540	
60							24	4,750	39	4,880	48	4,960	54	5,020	59	5,080	62	5,000	
65							8	3,910	30	3,980	40	4,070	51	4,130	56	4,170	59	4,200	
70									25	3,230	38	3,300	47	3,360	53	3,430	57	3,480	
75									12	2,580	30	2,700	42	2,790	49	2,900	54	2,930	
80											25	2,150	37	2,220	45	2,270	51	2,300	
85											15	1,670	32	1,750	41	1,800	47	1,900	
90													26	1,340	37	1,400	44	1,430	
95													17	970	32	1,030	40	1,070	
100														26	710	36	750		
105																			
110																			
115																			

REDUCTIONS FROM MAIN BOOM CAPACITIES FOR STOWED JIBS - SFJ = Stowed Fixed Jib, STJ = Stowed Telescopic Jib

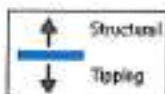

SFJ	450 lbs.	300 lbs.	240 lbs.	200 lbs.	180 lbs.	160 lbs.	140 lbs.	130 lbs.	120 lbs.
STJ	840 lbs.	560 lbs.	450 lbs.	380 lbs.	300 lbs.	290 lbs.	260 lbs.	230 lbs.	210 lbs.





NOTES:

- All loads rated at 360° pick
- Loads based on crane on outriggers
- All "on outriggers" loads are based on 85% tipping
- Loads above heavy line are based on structural rating
- Loads below heavy line are based on tipping rating

Data published herein is intended as a guide only. Crane operation is subject to machine specific load charts and information.

JIB LOAD CAPACITIES						
(ft.)	31 ft. Fixed Jib LMI Code #32		30.5 ft. Teles. Jib LMI Code #7		55 ft. Teles. Jib LMI Code #13	
		Load Capacity (lbs.)		Load Capacity (lbs.)		Load Capacity (lbs.)
30	60	4,000	79.5	3,300		
35	79	3,850	77.5	3,300	79.5	2,450
40	76	3,700	76	3,300	78	2,450
45	74	3,550	74	3,300	76.5	2,450
50	72	3,400	72	3,300	75	2,450
55	70	3,250	70.5	3,300	73	2,450
60	69	3,080	68.5	3,300	71.5	2,450
65	66	2,910	66.5	3,070	70	2,420
70	64	2,750	64.5	2,750	68	2,280
75	62	2,600	62	2,380	66	2,110









JIB LOAD CAPACITIES						
(ft.)	31 ft. Fixed Jib LMI Code #32		30.5 ft. Teles. Jib LMI Code #7		55 ft. Teles. Jib LMI Code #13	
		Load Capacity (lbs.)		Load Capacity (lbs.)		Load Capacity (lbs.)
80	60	2,480	60	2,050	64.5	1,940
85	58	2,280	58	1,680	63	1,760
90	56	1,950	56.5	1,250	61	1,680
95	53	1,690	53	950	59	1,440
100	51	1,370	50.5	570	57	1,280
105	48	880			55	970
110	45	620			53	750
115						
120						
125						

40124SHL LOAD CHART: Main Boom and Jib

Lifting Capacities 5-section Boom 30.8 ft - 123.5 ft
1 or 2-section Jib 31 ft - 55 ft - Full Outrigger Extension

 22 ft. (100%)

 360° Continuous





MAIN BOOM LMI CODE 1																		
(ft.)	30.8 ft.		47 ft. (A)		66 ft. (B)		69 ft. (C)		80 ft. (D)		91 ft. (E)		102 ft. (F)		110 ft. (G)		123.5 ft. (H)	
		Load Capacity (lbs.)		Load Capacity (lbs.)		Load Capacity (lbs.)		Load Capacity (lbs.)		Load Capacity (lbs.)		Load Capacity (lbs.)		Load Capacity (lbs.)		Load Capacity (lbs.)		Load Capacity (lbs.)
5	75	80,000																
8	69	60,000																
10	64	52,000	74	25,000														
12	60	46,000	72	25,000	76	25,000	79	25,000										
15	53	39,000	68	25,000	73	25,000	76	25,000	79	21,500								
20	46	31,300	61	25,000	67	25,000	72	23,900	75	19,700	79	17,100	79	14,500				
25	22	24,100	53	24,010	62	22,880	67	21,660	71	18,200	74	15,850	77	13,500	79	10,910	80	8,490
30			45	20,260	58	19,560	63	18,720	67	16,260	71	14,530	74	12,820	76	10,430	78	8,760
35			36	15,850	49	16,300	58	16,130	63	14,540	68	12,960	71	11,260	73	9,540	75	7,800
40			22	12,630	42	12,900	52	13,060	59	13,070	64	11,610	68	10,160	71	8,680	73	7,280
45					34	10,640	47	10,700	55	10,800	60	10,600	65	9,270	68	8,040	71	6,760
50					23	8,720	40	8,890	50	9,000	56	9,070	61	8,430	65	7,280	68	6,160
55							34	7,460	45	7,570	52	7,640	58	7,620	62	6,980	65	5,940
60							24	6,280	39	6,400	48	6,480	54	6,530	59	6,500	62	5,000
65							6	5,270	33	5,430	43	5,510	51	5,570	56	5,300	59	4,520
70									25	4,610	38	4,700	47	4,760	53	4,750	57	4,090
75									12	3,900	32	4,010	42	4,060	49	4,130	54	3,700
80											25	3,400	37	3,470	45	3,510	51	3,360
85											15	2,880	32	2,940	41	2,990	47	3,020
90												26	2,480	37	2,530	44	2,580	
95												17	2,060	32	2,120	40	2,160	
100													26	1,750	36	1,790		
105													18	1,410	31	1,460		
110														26	1,160			
115															19	880		
DEDUCTIONS FROM MAIN BOOM CAPACITIES FOR STOWED JIBS - SFJ = Stowed Fixed Jib, STJ = Stowed Telescopic Jib																		
SFJ	480 lbs.	300 lbs.	260 lbs.	200 lbs.	180 lbs.	160 lbs.	140 lbs.	130 lbs.	120 lbs.									
STJ	840 lbs.	560 lbs.	450 lbs.	380 lbs.	330 lbs.	290 lbs.	260 lbs.	230 lbs.	210 lbs.									







NOTES:

- All loads rated at 360° pick
- Loads based on crane on outriggers
- All "on outriggers" loads are based on 65% tipping
- Loads above heavy line are based on structural rating
- Loads below heavy line are based on tipping rating

Data published herein is intended as a guide only. Crane operation is subject to machine specific load charts and information.

JIB LOAD CAPACITIES							
(ft.)		31 ft. Fixed Jib LMI Code #32		30.5 ft. Teles. Jib LMI Code #7		55 ft. Teles. Jib LMI Code #13	
			Load Capacity (lbs.)		Load Capacity (lbs.)		Load Capacity (lbs.)
30	60	4,000	79.5	3,300			
35	79	3,860	77.5	3,300	79.5	2,450	
40	76	3,700	76	3,300	79	2,450	
45	74	3,550	74	3,300	78.5	2,450	
50	72	3,400	72	3,300	78	2,450	
55	70	3,250	70.5	3,300	77	2,450	
60	69	3,090	68.5	3,300	76.5	2,450	
65	66	2,910	66.5	3,070	70	2,420	
70	64	2,750	64.5	2,750	68	2,200	
75	62	2,600	62	2,360	66	2,110	

JIB LOAD CAPACITIES							
(ft.)		31 ft. Fixed Jib LMI Code #32		30.5 ft. Teles. Jib LMI Code #7		55 ft. Teles. Jib LMI Code #13	
			Load Capacity (lbs.)		Load Capacity (lbs.)		Load Capacity (lbs.)
80	60	2,480	60	2,050	64.5	1,940	
85	58	2,320	58	1,780	63	1,760	
90	55	2,170	55.5	1,600	61	1,580	
95	53	1,900	53	1,260	59	1,460	
100	51	1,720	50.5	1,050	57	1,280	
106	48	1,530	48	850	56	1,100	
110	45	1,350			53	900	
115	43	1,200			51	770	
120	40	1,020					
125	36	800					

40124SHL BOOM DIAGRAM

- FULLY EXTENDED OUTRIGGER CONFIGURATION -

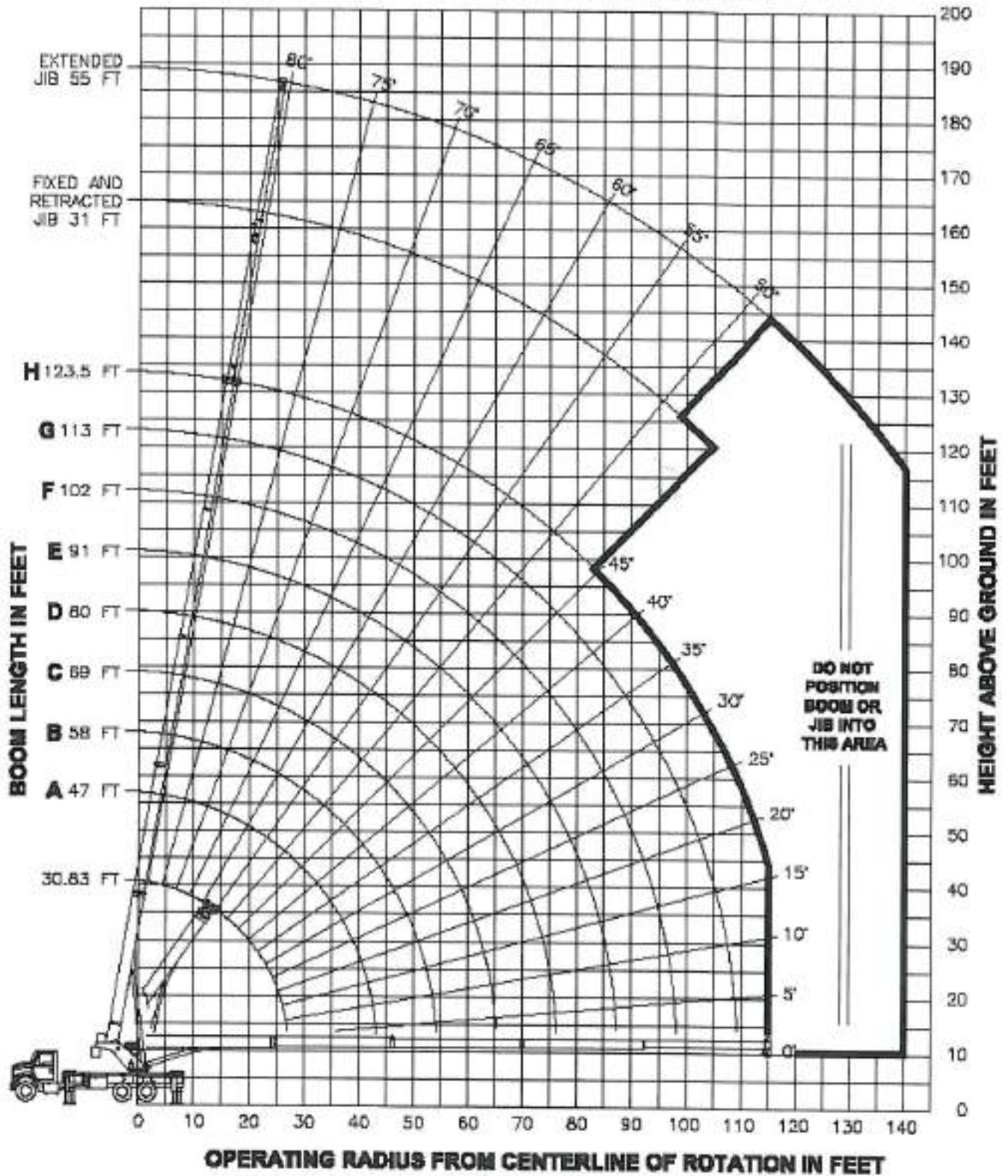

Information published herein is intended as a guide only. Crane operation is subject to machine specific load charts and information.

AREA OF OPERATION

In order to take advantage of full 360° rotation, the front bumper stabilizer must be set in accordance to the manual before working in this area and machine must be level.

If a front bumper stabilizer was not supplied, then the front tires must be in contact with the ground before working in this area.

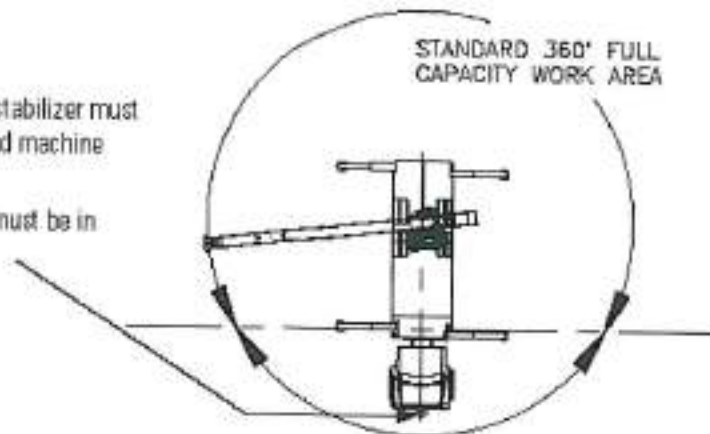

Deductions from rated loads for load handling devices supplied by Manitex

Auxiliary block	50 lbs. (22.7 kg)
Overhaul ball	See overhaul ball mfg. nameplate
Load blocks	See load block mfg. nameplate
Hose reel	260 lbs. (117.9 kg)
Swing around jib (stowed)	See load chart

WARNING: Lifting off the main boom point while the jib is erected is not intended nor approved.

REEVING DIAGRAM

ALLOWABLE LINE PULL								WARNING
1 PART LINE	2 PART LINE	3 PART LINE	4 PART LINE	5 PART LINE	6 PART LINE	7 PART LINE	8 PART LINE	
								<p>ANTI-TWO-BLOCK SYSTEM MUST BE IN GOOD OPERATING CONDITION BEFORE OPERATING CRANE.</p> <p>REFER TO THE OWNER'S MANUAL.</p> <p>KEEP AT LEAST 3 WRAPS OF LOAD LINE ON THE DRUM AT ALL TIMES.</p>
9500 LBS	19000 LBS	28500 LBS	38000 LBS	47500 LBS	57000 LBS	66500 LBS	76000 LBS	
10000 LBS	20000 LBS	30000 LBS	40000 LBS	50000 LBS	60000 LBS	70000 LBS	80000 LBS	5/8" 5 X 25 IWRC (3.5:1 SF) - 35000 LBS MIN BREAKING STRENGTH

Data published herein is intended as a guide only. Crane operation is subject to machine specific load charts and information.

LMI OPERATING CODES

Code	Crane Configuration	Outrigger Configuration	Area of Operation
#1	Main Boom	Fully Extended	Full 360°
#32	Fixed Jib	Fully Extended	Full 360°
#7	Telescopic Jib - Retracted	Fully Extended	Full 360°
#13	Telescopic Jib - Extended	Fully Extended	Full 360°
#25	Personnel lifting platform on main boom	Fully Extended	Full 360°
#33	Personnel lifting platform on fixed jib	Fully Extended	Full 360°
#26	Personnel lifting platform on tele. jib - retracted	Fully Extended	Full 360°
#29	Personnel lifting platform on tele. jib - extended	Fully Extended	Full 360°
#4	Main Boom	Mid Extension	Full 360°
#34	Fixed Jib	Mid Extension	Full 360°
#19	Telescopic Jib - retracted	Mid Extension	Full 360°
#22	Telescopic Jib - extended	Mid Extension	Full 360°
#5	Main Boom	Fully Retracted	Full 360°

Warning

1. The operator must read and understand the owner's manual before operating the crane.
2. Positioning or operation of crane beyond areas shown on these charts is not intended or approved except where specified in owner's manual.
3. Loaded boom angles at specified boom lengths give only an approximation of the operating radius. The boom angle before loading should be greater to account for deflections. Do not exceed the operating radius for rated loads.
4. The operating radius shown in the jib rating chart is for fully extended boom only. When boom is not fully extended, use only loaded boom angle to determine load rating of jib.
5. For boom angles not shown on jib load rating chart, use rating of next lower boom angle.
6. For boom lengths not shown, use rating of next shorter or longer boom length, whichever is less. For radii not shown, use rating of next longer radius.
7. Crane load ratings on outriggers are based on freely suspended loads with the machine leveled and standing on a firm uniform supporting surface. No attempt shall be made to move a load horizontally on the ground in any direction.
8. Practical working loads depend on supporting surface, wind, and other factors affecting stability such as hazardous surroundings, experience of personnel, and proper handling, all of which must be taken into account by the operator.
9. The maximum load which may be telescoped is limited by hydraulic pressure, boom angle, and boom lubrication. It is safe to attempt to telescope any load within the limits of the load rating chart. Boom must be fully retracted against boom stops at all times when lifting minimum boom length capacity loads.
10. Lifting off the main boom point while the swing around jib is erected is not intended or approved.

Information

1. Deductions must be made from rated loads for stowed jib, optional attachments, hooks, and load blocks (See deduction chart on page 6). Weights of slings and all other load handling devices shall be considered a part of the load.
2. Load ratings above the blue line are structurally limited capacities. Load ratings below the blue line are stability limited capacities and do not exceed 85% of tipping.

Definitions

1. Operating radius is the horizontal distance from the axis of rotation to the center of the vertical hoist line or tackle with load applied.
2. Loaded boom angle as shown in the column head by  is the included angle between the horizontal and longitudinal axes of the boom base after lifting rated load at rated radius.

TECHNICAL DESCRIPTIONS

Boom



Boom lengths: Proportional boom

- 3-section 77 ft. (23.5 m)
- 4-section 108 ft. (33.1 m)
- 5-section 124 ft. (37.8 m)

5-sheave quick reeve boom point

Self lubricating slider pads



Max. tip height 4077S/SHL: 88 ft. (26.2 m)

Max. tip height 40100S/SHL: 108.7 ft. (33.1)

Max. tip height 40124S/SHL: 131.8 ft. (40.2)



Boom angle (min/max): -6° / 80°

Rotation



Ball-bearing swing circle with external gear
Double-reduction planetary gearbox driven by hydraulic motor



Slewing brake: Spring-applied pressure released automatic brake



Slewing speed: 1.5 - 2 rpm. (nominal)

Boom rotation: 360° continuous

Outriggers



Outriggers: Out-and-down style
FBS - Front Bumper Stabilizer (optional)
Outrigger monitoring system (for verification only)
Outrigger motion alarm

Full extension

- Front and rear: 22 ft. (6.7 m)

Middle extension

- Front and rear: 14.3 ft. (4.4 m)

Full retraction

- Front and rear: 7.1 ft. (2.2 m)



RCC Solid - Radio operated handheld controller for outrigger and FBS setup

Operator aids



- Wired LMI with crane function cut-offs for overload protection
- Wired anti-two block system

Hoist, Rope and Hook



Maximum theoretical line speed:
453 fpm (138 mpm)



Maximum theoretical bottom-layer line pull:
13,050 lbs. (5,919 kg)



Main winch cable diameter: 5/8 in.
(15.9 mm) rotation resistant



Line length: 380 ft. (115.8 m)



Main winch: Bent axis 2-speed hydraulic motor
(activated electrically)



Load block: 5T (4.5 mt) capacity hook with heavy-duty swivel and weight is provided for single line operation.

Hydraulics



8-bolt direct mounted PTO and SAE C output
(factory mounted units only)

3-section vane pump, SAE C input

Hydraulic reservoir capacity:
115 gal. (435 L)

Pump sections @ 2000 rpm with 100 psi

- Shaft end pump: 41.67 gpm (158 lpm)
- Center pump: 28.3 gpm (107 lpm)
- Cover end pump: 11.7 gpm (44 lpm)

Tilttable Cab/Cab Controls



Standard features:

Curved glass, 0° to 20° cab tilt, Automotive door, heated cloth seat, 8 seat adjustments, lumbar support and adjustable head rest, sliding windows, rear pop out window, top hinged hatch, standard diesel fired heater, retractable sun screen, 12 volt DC outlet, E-coated cab (10 year rust warranty)



Controls:

PLC crane controller, CANBUS communication, J1939 truck engine communication capability, electronic hand and foot throttle, Hirschmann/PAT iScout D3 LMI system

OPTIONS

Boom

Max. Tip Height



- 4077S and 4077SHL
 - Max. tip height: 86 ft. (26.2 m)
- 40100S & 40100SHL
 - Max. tip height: 108.7 ft. (33.1m)
- 40124S & 40124SHL
 - Max. tip height: 131.8 ft. (40.2 m)

Jibs

- 40100S, 40100SHL, 40124S & 40124SHL
 - 1-section fixed jib: 30.5 ft. (9.3 m)
 - 2-sections telescopic jib: 30.5 ft (9.3 m) - 55 ft. (16.8 m)

Max. Tip Height with Extension



- 40100S & 40100SHL
 - Max. tip height with extension: 163.5 ft. (49.8 m)
 - Max. tip height with extension retracted: 139.3 ft. (42.4 m)
- 40124S & 40124SHL
 - Max. tip height with extension: 186.7 ft. (56.9 m)
 - Max. tip height with extension retracted: 163 ft. (49.7 m)

Max. Boom Length



- 4077S
 - Max. boom length 76.8 ft. (23.4 m)



- 40100S
 - Max. boom length with extension: 155 ft. (47.2 m)
- 40124S & 40124SHL
 - Max boom length with extension: 178.5 ft. (54.4 m)



- 40100S
 - Max. boom length with extension retracted: 130.5 ft. (39.8 m)
- 40124S & 40124SHL
 - Max boom length with extension retracted: 154 ft. (46.9 m)

Bulkhead

24 in. (607 mm) bulkhead

Hoist and Hook

2

- Auxiliary winch same as main winch, includes rooster sheave
- Wireline options available
- 2nd overhaul ball available
- 3rd wrap limiter main and auxiliary winch



- Auxiliary lower sheave block for 2-6 part lines
- Load blocks 1-3, 1-6, 2-6 part lines

Hydraulics



- Hose reel – boom mounted.
- Front Bumper Stabilizer (FBS)

Cab



- Airconditioner
- Engine monitoring system
- Video camera (1 or 2)
- Cab weather band radio system
- Wireless wind speed indicator

Operator Aids



- 4-function radio remote crane control system either with paddles or joy sticks
 - 900 Mhz + 433 Mhz
- Remote Winch Control System for main and auxiliary winches

2-person Basket



- Consult Manitex for specific application and rating
 - 2-person gravity level basket
 - 2-person rotating steel basket
 - 2-person quick attach rotating basket

Tool Boxes & Flatbed

- 24 in. L x 18 in. W x 18 in. H (610 mm L x 457 mm W x 457 mm H)
- 48 in. L x 24 in. W x 24 in. H (1,219 mm L x 610 mm W x 610 mm H)
- 8 ft. (2.4 m) flatbed - wood or steel
- 10 ft. (3 m) flatbed - wood or steel

Manitex



TC400

40-ton (36,3 mt) TELESCOPIC CRANE
TC400 SERIES PRODUCT GUIDE

UPTime

UPTime is the Manitex commitment to complete support of thousands of units working every day.

MANITEX
3000 South Austin Avenue
Georgetown, Texas 78626
1-877-314-3300 | www.Manitex.com

MCX T0400-PC-EN-12-001 5