



10010Mx

*50 Ton Tele-Boom
Crawler Crane*



SPECIFICATIONS & LOAD CHARTS

<https://cranemanuals.com>

Courtesy of Crane.Market

Pure Excellence...

any way you like it.

For over thirty years, Mantis telescopic boom crawler cranes have set the global standard with the dependability, versatility and performance expected of a market leader. Mantis cranes are built like no other. At their hearts, are massive steel fabrications, over-sized to handle the toughest jobs, year-in and year-out. Powerful state-of-the-art hydraulics coupled with diesel engines available in a choice of sizes match perfectly to meet the most rigorous of project demands.

Mantis remains one of the few crane makers prepared and equipped to work with contractors and project engineers to develop customized lifting solutions that meet the most unusual of project challenges. Thanks to the versatile combination of heavy duty telescopic booms, hydraulically extendable crawlers, and extremely compact dimensions, Mantis cranes can often get closer to a job than bulkier, fixed length lattice boom crawler cranes or rubber-tired cranes that need outriggers to work effectively.

No other crane combines so many valuable features:

- Pick-and-carry the full crane load chart through 360°.
- Lift and walk...even with tracks retracted.
- Climb steeper grades more safely, thanks to minimized counterweight and low center of gravity.
- Pull through deep mud without bogging down.
- Telescope or lift the boom with a full load on the hook.
- Save time and money on the job due to its low clearance height, retract on-the-fly tracks and telescopic boom.
- Independent hydrostatic track drive allows pivot turns to run rings around RTs.
- Hydraulic tool circuit option powers wide choice of Mantis-approved tools.
- New luxury cab with state-of-the-art operator aids.
- Saves time and money on deployment and shipping with less haul vehicles, less time wasted on boom erection and fewer personnel on the erection crew.

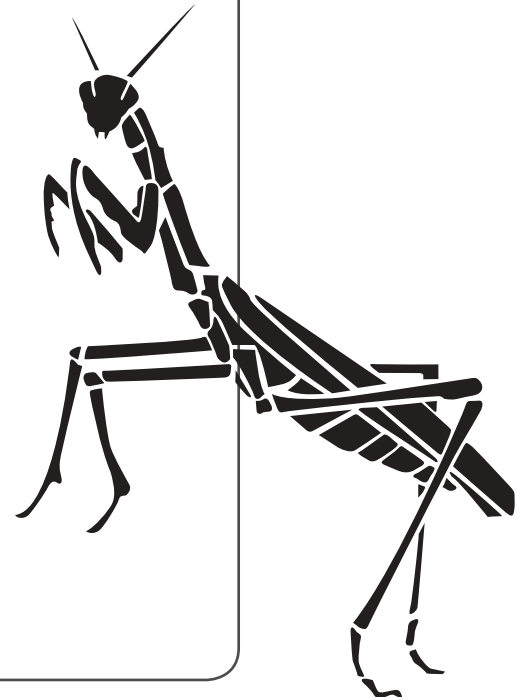

MANNTIS



MANTIS[®]
GRANES

10010Mx

MANTIS® 10010Mx

50 TON TELE-BOOM CRAWLER CRANE

Job-proven for more than 5-years on some of the most demanding projects, the Mantis 10010Mx has established itself as the benchmark for 50-ton (45-tonne) capacity telescopic boom crawler cranes - worldwide. Rated at 50-ton (45-tonne) lifting capacity at a full 10ft (3m) radius, the Mantis 10010Mx can pick-and-carry its entire load chart through a full 360°. Extending the performance potential of the 10010Mx is a long 111ft 6ins (34m) four-section full power telescopic boom. Such is the extraordinary stability of the 10010Mx that, with tracks extended, the crane can still make lifts with the main boom fully telescoped and laid-out horizontally.

Lifting at height the 10010Mx also shows its strength with 35,000lbs at 25ft radius (or 15.3-tonnes @ 8m) on the fully elevated and telescoped main boom. For increased height the 10010Mx deploys lattice extensions offering 18,000lbs 8.2-tonnes) to 147ft (44.8m) tip height of 6,600lbs (3-tonnes) to 167ft (50.9m) on offsettable jibs. Should narrow roadways demand lifting with tracks retracted for 11-12ft (3.35-3.66m) overall width, the 10010Mx can still walk with 42,600lbs (19.3-tonnes) on a fully telescoped 111ft 6ins (34m) main boom and swing it through 360°.

For its size and power, the Mantis 10010Mx has an extraordinarily low center of gravity with an overhead clearance height of just 10ft (3.05m). And like all Mantis cranes, the 10010Mx doesn't depend upon massive counterweighting for its strength - for big counterweights are a liability when climbing grades!

KEY FEATURES INCLUDE:

- 50-tons (45-tonnes) pick-and-carry capacity at 10ft (3m) radius thru 360°.
- Sequence-synchronized four-section full power boom of 111ft 6ins (34m) length.
- Lattice boom extensions and offsettable jibs for up to 167ft (50.9m) tip height.
- 215 hp (168kW) diesel engine standard.
- Low ground bearing pressure of 7.3 psi (0.52 kg/cm²).
- Mantis-engineered in-situ auger options with optional hydraulic tool circuit.
- Fast two-speed independent hydrostatic track drive to 2.9 mph (4.7 km/hr).
- Full boom telescoping and boom lift under full hook load.
- 11-to-12ft (3.35-3.66m) minimum travel width according to track width.
- Extraordinary 10ft (3.05m) overhead clearance height.
- New deluxe operators cab and standard LMI and Anti-Two-Block devices.
- Choice of track shoe widths, Apex swamp pads or bolt-on rubber track pads to suit any ground surface.
- 103,000lb (45-47-tonne) shipping weight fully equipped – hauls as a single, ready-to-work load.
- Steep 57% gradeability thanks to low centre of gravity.
- Hydraulic on-the-fly track frame retraction and extension.
- Powerful 17,500lb (7.9-tonne) planetary main winch with full load single line speeds to 228 fpm (69.5 mpm) or 489 fpm (149 mpm) no-load speed.
- Optional Mantis WP-750 Heavy Duty Work Platform for up to 152ft (46.4m) working height.
- High 14ins (356mm) ground clearance helps avoid damage and snagging.



HIGHWAY CONSTRUCTION

Mantis cranes make excellent tools for the vast variety of work involved in highway and bridge construction. Low clearance height and narrow working widths keep the traffic flowing, full pick-and-carry capacity and the flexibility of telescopic adjustment of boom length eases the delicate placing of heavy bridge beams. Low ground bearing pressures means no stops for bad weather or soft ground.



EASY LOADER

The 10010Mx closes down to a width of 12ft (3.66m), a clearance height of 10ft (3.05m) and an overall length of just 47ft 4ins (14.43m). It can ship with counterweight intact and scales in at 103,640lbs (47-tonnes) fully rigged with block, ball, jib & extension and auger kit. In most cases it can be loaded on a single trailer with no disassembly in a matter of minutes and arrive at the job site ready to work.



PETRO CHEM

Oil and gas transfer facilities are busy and congested. The Mantis cranes ability to telescope the entire load chart or lift it on the boom hoist cylinder can prove invaluable threading loads between obstructions. Being able to walk a load into place, narrow the crane with tracks retracted, change boom length in seconds and pivot on the spot puts the Mantis in a different league from cumbersome lattice crawlers and RTs with their big footprints and lifting limitations.



POWERLINE

Picking and walking with heavy, bulky and awkward loads like power transmission poles is a challenge for most cranes and crane operators. To complete the job safely and efficiently, you need a crane with very low center of gravity and minimal counterweight to offset backward tilting moment. When combined with full pick-and-carry capacity, minimum ground bearing pressure, maximum stability, strong, rigid structures and fine precision load control the Mantis becomes the ideal transmission line construction tool.

GENERAL CONSTRUCTION

Mantis cranes make excellent tools for the vast variety of work involved in construction. Low clearance height, narrow working widths, full pick & carry capacity and the flexibility of telescopic adjustment of boom length eases the delicate placement of parking deck panels. Low ground bearing pressures allows a 10010Mx and 14010 to maneuver on a concrete floor.



SPECIFICATIONS

MANTIS® 10010Mx 50 TON TELE-BOOM CRAWLER CRANE

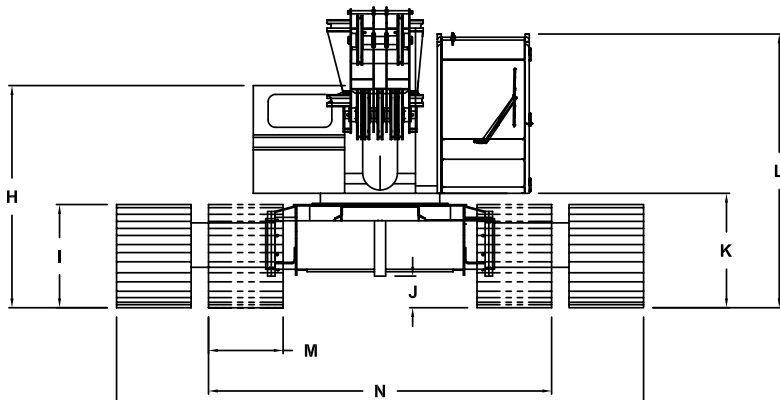
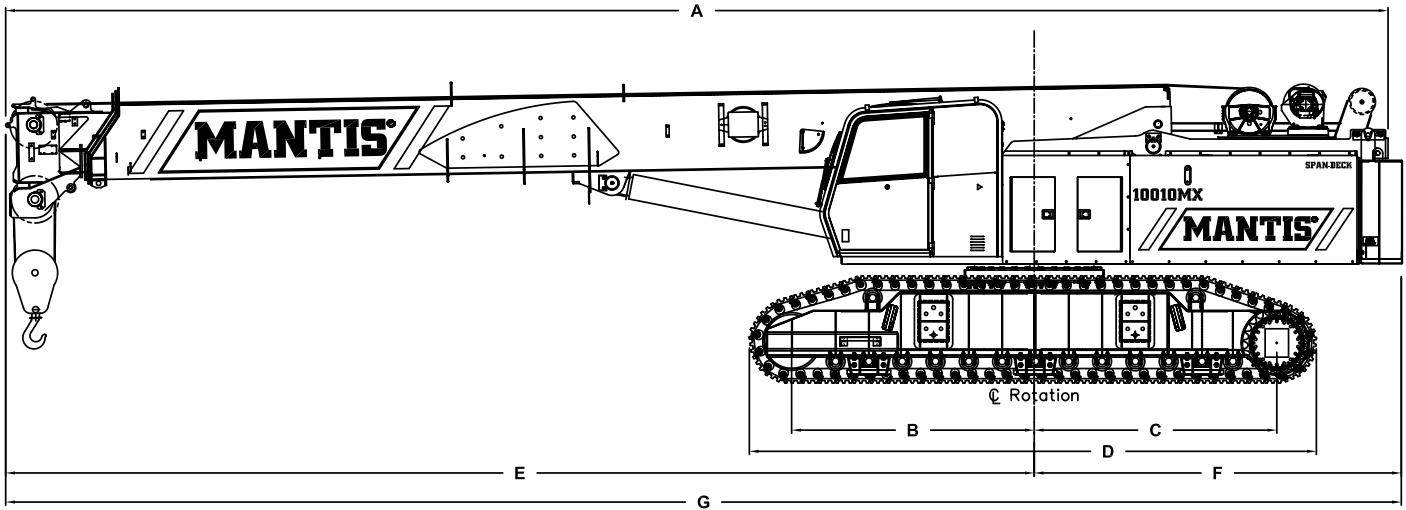

PRINCIPAL DIMENSIONS

Dimension	Description	Value
A	Length (Counterweight Removed)	46 ft 11 in (14.30 m)
B	CL Front Track Drive to CL Rotation	8 ft 2 in (2.49 m)
C	CL Rear Track Drive to CL Rotation	8 ft 2 in (2.49 m)
D	Track Length	19 ft 0 in (5.79 m)
E	Boom Length to Rotation	34 ft 1 in (10.39 m)
F	Tailswing	13 ft 8 in (4.17 m)
G	Overall Length	47 ft 4 in (14.43 m)
H	Ground to Top of Engine Cover	8 ft 4 in (2.54 m)
I	Track Height	42 in (1.07 m)
J	Ground Clearance	13 in (330 mm)
K	Ground to Bottom of Cab	48 in (1.22 m)
L	Maximum Overall Height	9 ft 5 in (2.87 m)
M	Track Width	36 in (900 mm)
N	Overall Width (Tracks Retracted)	12 ft 0 in (3.66 m)
O	Overall Working Width	18 ft 4 in (5.59 m)

WIDTHS, WEIGHTS, AND GROUND PRESSURES*

Shoe Width	Overall Width		Area	Ground Pressure	Working Weight
	Retracted	Extended			
24 in (609 mm)	11 ft 0 in (3.35 m)	17 ft 2 in (5.23 m)	9,360 in ² (6.04 m ²)	10.7 psi (0.75 kg/cm ²)	99,690 lb (45,220 kg)
30 in (762 mm)	11 ft 6 in (3.51 m)	17 ft 8 in (5.39 m)	11,700 in ² (7.55 m ²)	8.7 psi (0.61 kg/cm ²)	101,670 lb (46,120 kg)
36 in (900 mm)	12 ft 0 in (3.66 m)	18 ft 4 in (5.59 m)	14,040 in ² (9.06 m ²)	7.4 psi (0.52 kg/cm ²)	103,640 lb (47,010 kg)

* Crane equipped with: 111 ft 6 in boom, extension, jib, 50 ton hook block and 12 ton headache ball

SPECIFICATIONS

MANTIS® 10010Mx 50 TON TELE-BOOM CRAWLER CRANE

STANDARD CRANE AND EQUIPMENT

Boom

The boom consists of four full powered sections, 37 ft 6 in (11.43 m) retracted to 111 ft 6 in (33.99 m) fully extended. Maximum tip height is 117 ft (35.66 m).

Boom Telescoping & Elevating Systems

The telescoping system features two double-acting hydraulic cylinders and counterbalance lock valves. The elevating system features a cylinder and counterbalance lock valve which provide boom elevations from -1° to 78°.

Boom Head

Seven 19 in (483 mm) diameter, cast nylon sheaves on heavy-duty roller bearings are mounted in the boom head.

SUPERSTRUCTURE

Frame

The frame is an all-steel, welded structure, precision machined to accept attachment of the boom and swing devices.

Operator's Cab

The fully-enclosed, air conditioned all-steel modular cab includes a lockable swinging door, acoustical lining, anti-slip floor and tinted safety glass. Sliding windows are located in the cab door and cab boom side. A vent window is positioned in the rear of the cab. Grab bars and steps are appropriately located for easy access to the cab. Erectable swing barricades are attached to the superstructure. Rear view cameras are appropriately located as are work lights.

Standard cab accessories include a two-speed windshield wiper, top glass wiper, defroster, heater, circulating fan, adjustable hand and foot throttles, six-way adjustable fabric seat with headrest, seat belt, dome light, and a dry-chemical fire extinguisher.

Instrumentation

Dash instrumentation features a tachometer, voltmeter, oil pressure gauge, temperature gauge, hour meter and fuel gauge. Indicators are provided for crane level, load moment, drum rotation, air filter restriction, hydraulic oil temperature and filter restriction, engine oil pressure and temperature.

A termination switch is located in the seat and armrest and is capable of immediately disabling all hydraulic functions as the operator rises from the seat or it can be activated by lifting the left hand armrest.

Control

Two-way hydraulic joysticks mounted in the operator's seat armrests control swing, auxiliary hoist, main winch and boom hoist. Four two-way hydraulic foot pedals control travel, swing service brake and boom telescoping functions. A fifth pedal controls engine speed.

Counterweight

The one piece 20,000 lb (9,070 kg) counterweight can be removed and installed via a pendant attached to the boom.

Load Moment Indicator & Anti-Two Block¹

Standard Rated Capacity Limiter and Anti-Two Block system with audio-visual warning and control function shutdown. System's LCD screen provides a continuous electronic display of working boom length, boom angle, working load radius, tip height, parts-of-line (operator set), machine configuration, relative load moment, maximum permissible load and actual load. The standard Work Area Definition system allows the operator to pre-set and define working areas. Should pre-set limits be approached, audio-visual warnings aid the operator in avoiding job-site obstructions. The anti-two block weight allows quick reeving of hook blocks.

Swing

The superstructure rotates 360° around a shear ball slew bearing with an external gear that matches with the swing drive pinion and bolts to the superstructure and the carbody. The hydraulic swing drive powers the system and consists of a gear motor driving into a planetary reducer with a shaft mounted pinion providing infinitely variable speeds of up to 3 rpm. Swing braking is achieved through a "failsafe", hydraulically released, spring applied, multi-disc wet brake which includes a foot applied service brake. The brake can be electrically actuated through a cab mounted switch into a "locked-on" (parking) mode. A two position house lock system is included. Regular lubrication of the bearing is achieved through a cab mounted grease applicator.

Fuel System

An 80 US gal (303 l) tank is bolted to the superstructure. The fuel filtration system consists of an inline fuel/water separator as well as an engine mounted fuel filter.

Hydraulic System

The load sensing, open-loop hydraulic system is served by two variable volume pumps mounted in tandem. The pumps are horsepower limiting and pressure compensated providing a maximum output of 168 gpm (636 l/min) @ 2,200 rpm and maximum operating pressure of 4,850 psi (339.5 kg/cm²). An extra circuit is included for ready adaptation to hydraulic accessories. The system includes two pilot operated valve banks that are pressure and flow compensated. The 300 US gal (1,136 l) capacity hydraulic oil reservoir has a spin-on filler-breather cap, external sight gauge, clean-out access and a sump type drain. An air to oil remote mounted cooler provides oil cooling with thermostatically-controlled, electrically driven fans. Hydraulic oil filtering is achieved with two 5 micron full flow cartridge type filters designed to return in-tank with bypass protection and an electronic bypass indicator.

(System pressure test ports with quick disconnect fittings are provided for diagnostics.)

SPECIFICATIONS

MANTIS® 10010Mx 50 TON TELE-BOOM CRAWLER CRANE

MAIN HOIST

Planetary geared two-speed winch includes a bent axis, variable displacement hydraulic motor and a multi-disc internal brake. Wire Rope: 600 ft (182 m) 5/8 in (16 mm) 6 x 37 EIPS, IWRC, RRL. Line pulls are not based on wire rope strength. Drum rotation indicator is standard.										
Rope Layer	Maximum Line Pull		No Load Line Speed		Full Load Line Speed		Pitch Diameter		Layer	
1	17,500 lb	7,940 kg	384 ft/min	117.0 m/min	178 ft/min	54.3 m/min	11.4 in	288.9 mm	76 ft	23.2 m
2	15,700 lb	7,120 kg	414 ft/min	126.2 m/min	193 ft/min	58.8 m/min	12.5 in	316.3 mm	83 ft	25.4 m
3	14,300 lb	6,490 kg	433 ft/min	132.0 m/min	202 ft/min	61.6 m/min	13.5 in	343.6 mm	91 ft	27.6 m
4	13,100 lb	5,940 kg	451 ft/min	137.5 m/min	210 ft/min	64.0 m/min	14.6 in	370.9 mm	98 ft	29.8 m
5	12,100 lb	5,490 kg	482 ft/min	146.9 m/min	225 ft/min	68.6 m/min	15.7 in	398.3 mm	105 ft	32.0 m
6	11,300 lb	5,130 kg	489 ft/min	149.0 m/min	228 ft/min	69.5 m/min	16.8 in	425.6 mm	112 ft	34.2 m

AUXILIARY HOIST

Planetary geared single-speed winch includes a bent axis, variable displacement hydraulic motor and a multi-disc internal brake. Wire Rope: 350 ft (107 m) 5/8 in (16 mm) 6 x 37 EIPS, IWRC, RRL. Line pulls are not based on wire rope strength. Drum rotation indicator is standard.										
Rope Layer	Maximum Line Pull		Full Load Line Speed		Pitch Diameter		Layer		Total	
1	12,000 lb	5,440 kg	182 ft/min	55.5 m/min	10.4 in	263.5 mm	60 ft	18.2 m	60 ft	18.2 m
2	10,700 lb	4,850 kg	196 ft/min	59.7 m/min	11.5 in	290.9 mm	66 ft	20.1 m	126 ft	38.3 m
3	9,800 lb	4,450 kg	208 ft/min	63.4 m/min	12.8 in	324.8 mm	74 ft	22.5 m	199 ft	60.8 m
4	9,000 lb	4,080 kg	217 ft/min	66.1 m/min	14.1 in	358.8 mm	81 ft	24.8 m	281 ft	85.6 m
5	8,300 lb	3,760 kg	233 ft/min	71.0 m/min	15.5 in	392.8 mm	89 ft	27.1 m	370 ft	112.7 m

STANDARD ENGINE

Cummins QSB215 (U.S. EPA Tier 3)					
Noise Emissions: Top 96.3 dBA (excludes noise from intake, exhaust, cooling system and driven components)					
Type	6 cyl Water Cooled	Weight (Wet)	1056 lb (479 kg)	Aspiration	Turbocharged & Aftercooled
Displacement	360 cu in (5.9 l)	Oil Capacity	17.2 US quarts (16.3 l)	Air filter	Dry Type
Bore	4.02 in (102 mm)	Rated Horsepower	215 @ 2200 rpm	Electrical System	12 volt
Stroke	4.72 in (120 mm)	Peak Torque	692 ft/lb @ 1500 rpm	Alternator	100 amp

MACHINE WEIGHTS

STANDARD CRANE WITH 4 SECTION 111 ft 6 in (33.99 m) BOOM, 1 PIECE COUNTERWEIGHT & 36 in (914 mm) TRACK SHOES	99,536 lb	45,150 kg
Crane Less Counterweights and Track Frames	55,936 lb	25,370 kg
Counterweight	20,000 lb	9,070 kg
Track Frames, 2 pieces 11,800 lb (5,350 kg) each	23,600 lb	10,700 kg
OPTIONAL EQUIPMENT		
30 ft (9.14 m) Lattice Extension	1,700 lb	771 kg
20 ft (6.10 m) Jib (connects to head of Lattice Extension ONLY)	700 lb	318 kg
Auxiliary Nose Sheave	210 lb	95 kg
12 ton (11 mt) Headache Ball	404 lb	183 kg
50 ton (45 mt) Hook Block	1,300 lb	590 kg
Auxiliary Winch with Standard Rope	685 lb	311 kg
Auger Ready Package	440 lb	200 kg
Complete Auger Package	1520 lb	690 kg
60 in (1.52 m) Auger Kelly Bar	120 lb	54 kg
72 in (1.83 m) Auger Kelly Bar	140 lb	64 kg

SPECIFICATIONS

MANTIS® 10010Mx 50 TON TELE-BOOM CRAWLER CRANE

UNDERCARRIAGE

Carbody

The welded steel, box type carbody is fabricated with square axles to accept the crawler side frames. The top surface is precision machined to receive the swing bearing.

Side Frames

Two welded steel removable side frames are paired with a track group consisting of two top and thirteen bottom oil-filled and sealed rollers. Each frame includes an oil-filled, self-lubricating idler and spring type, track tensioning device. Standard track shoes are 36 in (900 mm) wide, 3-bar semi-grousers. Optional shoes are available in 24 in (609 mm) and 30 in (762 mm) widths flat pad and semi grouser configurations. 36 in flat pads are also available. The side frames extend and retract hydraulically and are electrically controlled from the cab.

Travel

Each side frame contains a pilot controlled, two-speed track drive. The drives are hydraulic piston motors which propel the crane at a low speed of 1.6 mph (2.6 km/hr) and at a high speed of 2.9 mph (4.7 km/hr). The internal brake system is spring applied and automatically released upon actuation of the travel system.

The hydraulic travel system provides skid steering and track counter-rotation and achieves an unladen gradeability of 57%.

OPTIONAL EQUIPMENT

Boom Attachments

- **Boom Extension:** 30 ft (9.14 m), lattice type swingaway that stores alongside of the boom base section and can be used with or without the optional 20 ft (6.10 m) jib. Head contains two 19 in (483 mm) diameter high strength cast nylon sheaves mounted on heavy-duty roller bearings, reeving up to 2 parts of wire rope. With optional extension deployed maximum tip height is 147 ft (44.81 m).
- **Boom Jib:** 20 ft (6.10 m) lattice type swing-away, attaches to and stores alongside the extension and can only be used with the extension deployed. Offsets are at 15° & 30°. With optional jib and extension deployed maximum tip height is 167 ft (50.90 m).
- **Auxiliary Nose Sheave:** quick reeve, single 19 in (483 mm) diameter high-strength, cast nylon sheave mounted on a heavy-duty roller bearing.
- **Wire Rope:** rotation resistant, (non-spin) Dyform-18 HSLR.
- **Headache Ball:** 12 ton (11 mt) ball includes a swivel hook with safety latch.
- **Hook Block:** 50 ton (45 mt) hook block consists of five 16 in (406 mm) diameter sheaves mounted on heavy-duty roller bearings with a swivel hook and safety latch.

Hydraulic

- **Auger Ready Package:** includes hoses, fasteners and stowage bracket assembly mounted to the base section of the boom with a flow capability of 34 gpm (130 l/min).
- **Complete Auger Package:** adds a two speed auger motor/gear box and one 60 in (1.52 m) kelly bar to the Auger Ready Package.
- **Tool Circuit:** provides 6 gpm (23 l/min) and 12 gpm (45 l/min) at 2,500 psi (176 kg/cm²) through a 50 ft (15.24 m) twin hose reel with quick disconnect fittings to operate open center tools.

Other Options

- **Free Fall Hoists:** all winches are available in free fall and controlled free fall configurations.
- **Crane Cab Access Walkways:** a pair of 54.5 in (1 384 mm) wide x 25 in (635 mm) deep walkways which attach to both the front and rear of the carbody and allow for easier egress and ingress to the operator's cab when the crane's upper rotating frame is not aligned front to rear.
- **Model WP750 Work Platform:** 36 in x 72 in (914 mm x 1 828 mm), all-steel, welded, two-person platform with a maximum capacity of 750 lb (340 kg). A test weight and boom head adapter are included in the package. Operation and control are by the crane operator from the cab. Radio (RF) controls to enable remote operation from the platform are available.

(See separate WP750 Specification for a complete description of standard and optional Work Platform equipment.)

*Load moment indicating and anti-two block systems are operator aids and must never be used in lieu of job site lift planning calculations by the operator which must take into account ground conditions, weather and all other environmental factors prevailing at the time of the lift. Prices and specifications are subject to change at any time without prior notice and are for factory installation at time of original manufacture. F.O.B Plant; Richlands, VA 24641. Illustrations and photographs may show optional equipment. Supercedes all previous issues. Please see www.mantiscranes.com for most current information.

LOAD CHARTS

MANTIS® 10010Mx 50 TON TELE-BOOM CRAWLER CRANE

111 FT 6 IN MAIN BOOM, 30 FT EXTENSION & 20 FT JIB

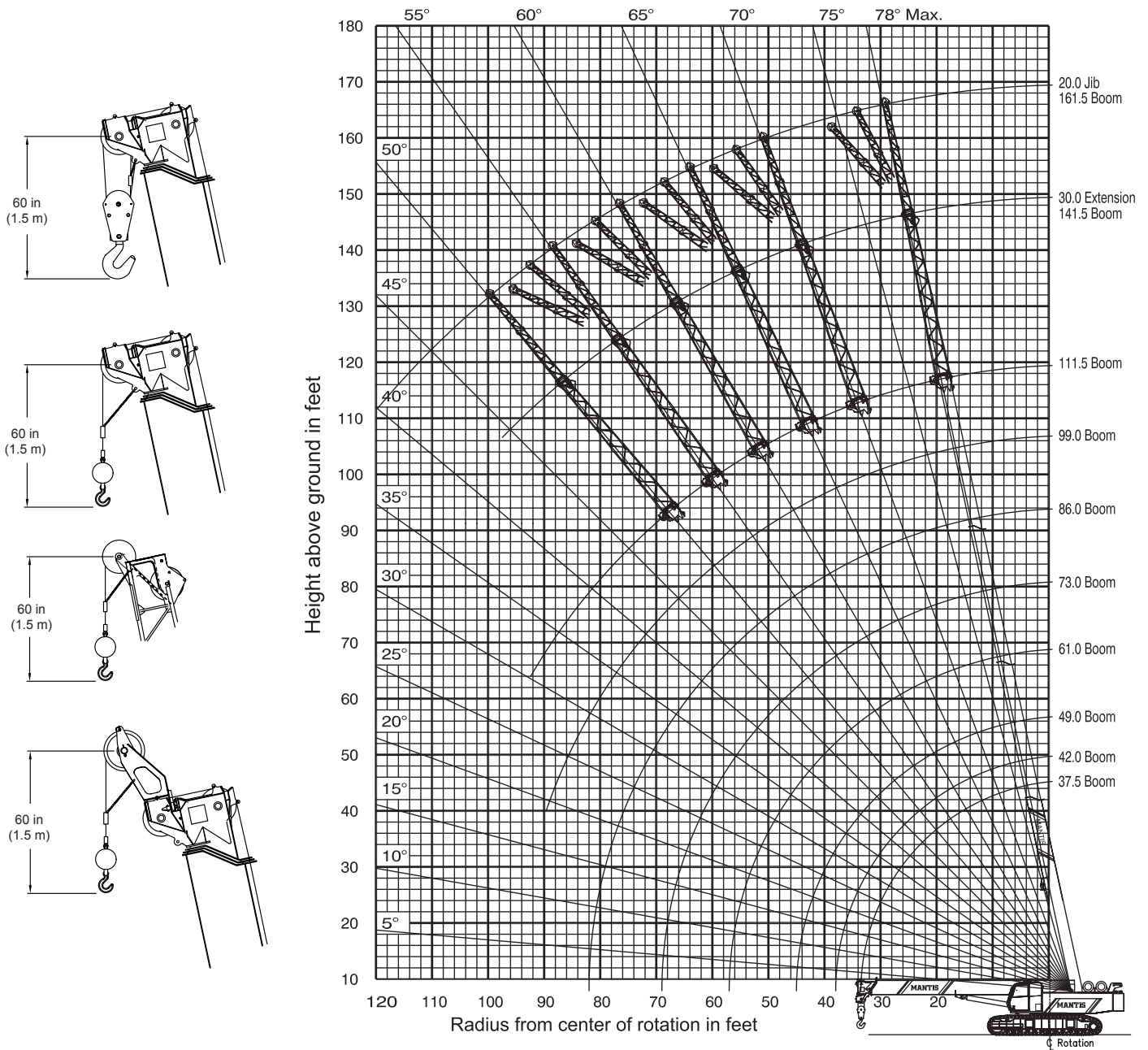

THESE CHART VALUES ARE ONLY A GUIDE AND MUST NOT BE USED TO OPERATE THE CRANE. USE ONLY THE IN CAB LOAD CHARTS AND OPERATOR'S MANUAL FURNISHED WITH THE CRANE.

<https://cranemanuals.com>

LOAD CHARTS

MANTIS® 10010Mx 50 TON TELE-BOOM CRAWLER CRANE

LIFTING CAPACITIES

IN THOUSANDS OF POUNDS; 360°, 75% OF TIPPING, FIRM & LEVEL GROUND

MAIN BOOM with TRACKS FULLY EXTENDED										
20,000 lb COUNTERWEIGHT										
RADIUS (ft)	MAIN BOOM LENGTH (ft)								RADIUS (ft)	
	37.5	42.0	49.0	61.0	73.0	86.0	99.0	111.5		
10	100.0	90.0	86.0	79.0*						10
	70.1 °	72.3 °	74.9 °	78.0 °						
12	82.5	80.0	76.0	72.0*						12
	66.8 °	69.4 °	72.5 °	76.0 °						
15	66.0	64.0	61.0	59.5	48.0	44.0*				15
	61.6 °	64.9 °	68.7 °	73.1 °	75.9 °	78.1 °				
20	53.2	51.1	49.1	51.4	43.0	40.0	38.0*			20
	52.2 °	57.0 °	62.2 °	68.1 °	71.8 °	74.7 °	76.7 °			
25	39.6	38.7	37.3	38.0	38.6	39.0	36.0	35.0*		25
	41.4 °	48.2 °	55.3 °	62.9 °	67.6 °	71.2 °	73.7 °	75.6 °		
30	29.5	29.0	28.7	28.5	29.2	29.9	30.2	30.5		30
	27.0 °	37.8 °	47.6 °	57.4 °	63.3 °	67.6 °	70.7 °	72.9 °		
35		22.3	22.0	21.8	22.5	23.3	23.7	24.1		35
		23.7 °	38.8 °	51.5 °	58.7 °	63.9 °	67.6 °	70.2 °		
40			16.8	16.6	17.3	17.9	18.6	19.1		40
			27.7 °	45.1 °	54.0 °	60.1 °	64.4 °	67.4 °		
45			12.8	13.2	13.7	14.3	15.0	15.5		45
			3.1 °	37.8 °	48.9 °	56.1 °	61.1 °	64.6 °		
50				10.5	11.1	11.7	12.4	13.0		50
				29.0 °	43.3 °	52.0 °	57.7 °	61.7 °		
55				8.4	8.9	9.7	10.4	10.8		55
				16.0 °	37.1 °	47.6 °	54.2 °	58.7 °		
60					8.0	8.4	8.7	9.0		60
					29.8 °	42.8 °	50.5 °	55.7 °		
65					6.7	7.0	7.3	7.6		65
					20.1 °	37.5 °	46.6 °	52.4 °		
70						5.7	6.0	6.3		70
						31.5 °	42.4 °	49.1 °		
75						4.6	5.0	5.3		75
						24.2 °	37.8 °	45.6 °		
80						3.7	4.1	4.4		80
						13.3 °	32.7 °	41.8 °		
85							3.2	3.6		85
							26.7 °	37.7 °		
90							2.7	3.0		90
							19.1 °	33.2 °		
95							2.1	2.4		95
							1.5 °	28.1 °		
100								1.9		100
								21.8 °		
105								1.1		105
								12.9 °		

* Capacity based on maximum obtainable boom angle.
° Boom angles are stated in degrees.



THESE CHART VALUES ARE ONLY A GUIDE AND MUST NOT BE USED TO OPERATE THE CRANE. USE ONLY THE IN CAB LOAD CHARTS AND OPERATOR'S MANUAL FURNISHED WITH THE CRANE.

LOAD CHARTS

MANTIS® 10010Mx 50 TON TELE-BOOM CRAWLER CRANE

LIFTING CAPACITIES

IN THOUSANDS OF POUNDS; 360°, 75% OF TIPPING, FIRM & LEVEL GROUND

MAIN BOOM with TRACKS FULLY RETRACTED		
20,000 lb COUNTERWEIGHT		
RADIUS (ft)	MAIN BOOM LENGTH (ft) 37.5 to 111.5	RADIUS (ft)
15	42.6	15
17	34.3	17
19	28.2	19
21	23.7	21
23	20.2	23
25	17.4	25
27	15.1	27
29	13.1	29
30	12.3	30
32	10.8	32
34	9.5	34
36	8.3	36
38	7.4	38
40	6.4	40
42	5.7	42
44	4.9	44
46	4.3	46
48	3.7	48
50	3.2	50
52	2.7	52
54	2.3	54
56	1.8	56
58	1.5	58
60	1.2	60

30' EXTENSION & 20' JIB						
with TRACKS FULLY EXTENDED						
20,000 lb COUNTERWEIGHT						
30' EXTENSION			20' JIB			
Boom Angle	Total Boom Length (ft)		Jib Offset Angles			Boom Angle
	67.5 to 110.0	> 110.0	0°	15°	30°	
78°	18.0	18.0	6.6	4.0	2.2	78°
75°	13.6	13.6	6.5	4.0	2.1	75°
72°	11.5	11.5	5.6	3.5	2.0	72°
70°	10.1	10.1	5.1	3.2	1.9	70°
68°	8.9	8.9	4.6	3.0	1.8	68°
65°	8.0	7.8	4.2	2.8	1.8	65°
62°	7.2	6.0	3.9	2.6	1.7	62°
60°	6.7	4.8	3.5	2.4	1.7	60°
58°	6.1	3.9	3.2	1.9	1.4	58°
55°	5.8	3.0	2.6	1.3	1.0	55°
52°	5.3	2.4	2.0	0.6	0.4	52°
50°	5.1	2.1	1.3	0.3	0.2	50°
48°	4.9	1.7				48°
45°	4.6	1.3				45°

° Boom angles are stated in degrees.

WEIGHT REDUCTIONS	
LOAD HANDLING DEVICES	
HOOKBLOCK: 50 Ton - 5 Sheave	1,300 lbs
OVERHAUL BALL: 12 Ton w/Swivel	396 lbs
OPTIONAL HANDLING DEVICES	
30 ft. Extension - Stowed**	350 lbs
30 ft. Extension - Erected**	2,000 lbs
30 ft. Ext. and 20 ft. Jib - Stowed**	750 lbs
30 ft. Ext. and 20 ft. Jib - Erected**	3,500 lbs
Auxillary Nose Sheave**	250 lbs

** Reduction of main boom capacities.

ZERO DEGREE BOOM ANGLE			
MAXIMUM CAPACITY			
with TRACKS FULLY EXTENDED			
20,000 lb COUNTERWEIGHT			
BOOM LENGTH (ft)	RADIUS (ft)	LOAD (lbs) (x 1000)	BOOM LENGTH (ft)
37.5	33.6	20.8	37.6
42	38.0	17.1	42
49	45.0	12.8	49
61	57.0	7.8	61
73	69.0	5.6	73
86	82.0	3.3	86
99	95.0	2.2	99
111.5	107.5	1.0	111.6



CAUTION

THESE CHART VALUES ARE ONLY A GUIDE AND MUST NOT BE USED TO OPERATE THE CRANE. USE ONLY THE IN CAB LOAD CHARTS AND OPERATOR'S MANUAL FURNISHED WITH THE CRANE.

LOAD CHARTS

MANTIS® 10010Mx 50 TON TELE-BOOM CRAWLER CRANE

LIFTING CAPACITIES

IN THOUSANDS OF POUNDS; 360°, 75% OF TIPPING, FIRM & LEVEL GROUND

AUXILIARY BOOM NOSE SHEAVE with TRACKS FULLY EXTENDED										
20,000 lb COUNTERWEIGHT										
RADIUS (ft)	MAIN BOOM LENGTH (ft)								RADIUS (ft)	
	37.5	42.0	49.0	61.0	73.0	86.0	99.0	111.5		
10	11.0	11.0	11.0	11.0						10
	70.1 °	72.3 °	74.9 °	78.0 °						
12	11.0	11.0	11.0	11.0						12
	66.8 °	69.4 °	72.5 °	76.0 °						
15	11.0	11.0	11.0	11.0	11.0	11.0				15
	61.6 °	64.9 °	68.7 °	73.1 °	75.9 °	78.1 °				
20	11.0	11.0	11.0	11.0	11.0	11.0	11.0	11.0		20
	52.2 °	57.0 °	62.2 °	68.1 °	71.8 °	74.7 °	76.7 °	°		
25	11.0	11.0	11.0	11.0	11.0	11.0	11.0	11.0		25
	41.4 °	48.2 °	55.3 °	62.9 °	67.6 °	71.2 °	73.7 °	75.6 °		
30	11.0	11.0	11.0	11.0	11.0	11.0	11.0	11.0		30
	27.0 °	37.8 °	47.6 °	57.4 °	63.3 °	67.6 °	70.7 °	72.9 °		
35		11.0	11.0	11.0	11.0	11.0	11.0	11.0		35
		23.7 °	38.8 °	51.5 °	58.7 °	63.9 °	67.6 °	70.2 °		
40			11.0	11.0	11.0	11.0	11.0	11.0		40
			27.7 °	45.1 °	54.0 °	60.1 °	64.4 °	67.4 °		
45			11.0	11.0	11.0	11.0	11.0	11.0		45
			3.1 °	37.8 °	48.9 °	56.1 °	61.1 °	64.6 °		
50				10.5	11.0	11.0	11.0	11.0		50
				29.0 °	43.3 °	52.0 °	57.7 °	61.7 °		
55				8.4	8.9	9.7	10.4	10.8		55
				16.0 °	37.1 °	47.6 °	54.2 °	58.7 °		
60					8.0	8.4	8.7	9.0		60
					29.8 °	42.8 °	50.5 °	55.7 °		
65					6.7	7.0	7.3	7.6		65
					20.1 °	37.5 °	46.6 °	52.4 °		
70						5.7	6.0	6.3		70
						31.5 °	42.4 °	49.1 °		
75						4.6	5.0	5.3		75
						24.2 °	37.8 °	45.6 °		
80						3.7	4.1	4.4		80
						13.3 °	32.7 °	41.8 °		
85							3.2	3.6		85
							26.7 °	37.7 °		
90							2.7	3.0		90
							19.1 °	33.2 °		
95							2.1	2.4		95
							1.5 °	28.1 °		
100								1.9		100
								21.8 °		
105								1.1		105
								12.9 °		

° Boom angles are stated in degrees.



CAUTION

THESE CHART VALUES ARE ONLY A GUIDE AND MUST NOT BE USED TO OPERATE THE CRANE. USE ONLY THE IN CAB LOAD CHARTS AND OPERATOR'S MANUAL FURNISHED WITH THE CRANE.

LOAD CHARTS

MANTIS® 10010Mx 50 TON TELE-BOOM CRAWLER CRANE

MANTIS WP-750 WORK PLATFORM

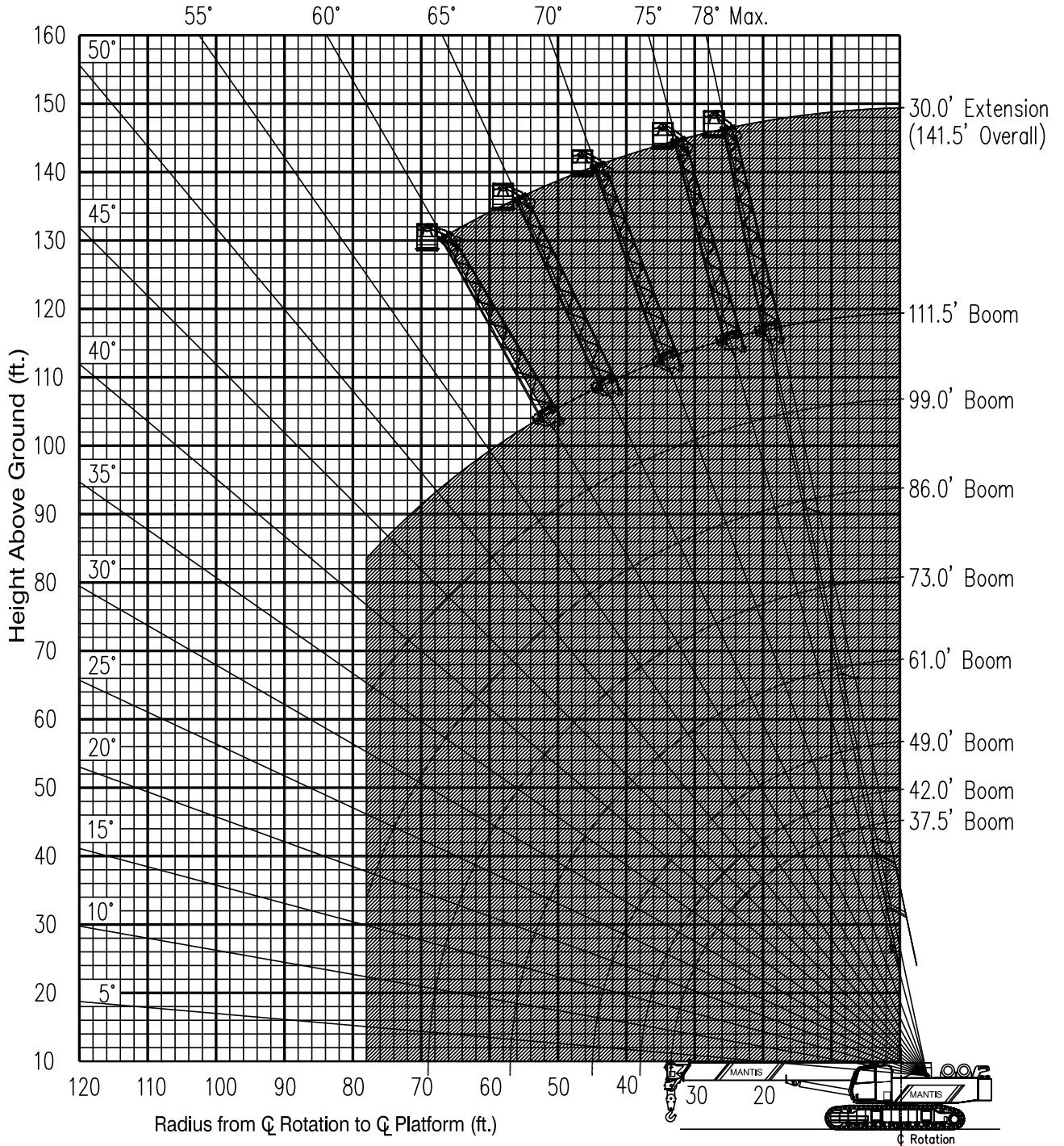

Limits of operation: Maximum load capacity = 750 lb Maximum radius when mounted on main boom = 78 ft



THESE CHART VALUES ARE ONLY A GUIDE AND MUST NOT BE USED TO OPERATE THE CRANE. USE ONLY THE IN CAB LOAD CHARTS AND OPERATOR'S MANUAL FURNISHED WITH THE CRANE.

LOAD CHARTS

MANTIS® 10010Mx 50 TON TELE-BOOM CRAWLER CRANE

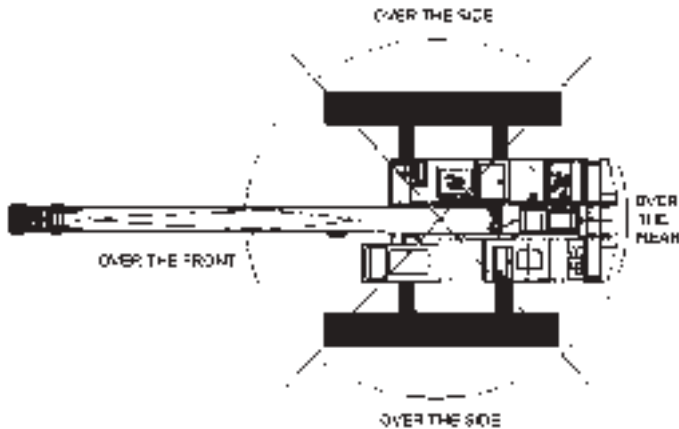

MANTIS MODEL 10010Mx				
WIRE ROPE LINE PULL CAPACITIES				
PARTS OF LINE	MAIN WINCH (pounds)	AUX WINCH (pounds)	PARTS OF LINE	MAIN WINCH (pounds)
1	16,800	16,800	6	100,800
2	33,600	33,600	7	117,600
3	50,400	N/A	8	134,400
4	67,200	N/A	9	151,200
5	84,000	N/A	10	168,000

5/8 inch diameter wire rope, 6 x 37 Class, EIP, IWRC

PLEASE READ, UNDERSTAND, AND FOLLOW THE MANUALS FURNISHED WITH THE CRANE (OPERATOR'S AND SAFETY) AS WELL AS THE CAPACITY LIMITATIONS AND GENERAL CONDITIONS LISTED BELOW PRIOR TO OPERATION OF THE CRANE. FAILURE TO DO SO MAY RESULT IN AN ACCIDENT.

Capacity Limitations and General Conditions:

- This MANTIS CRANE as manufactured, meets the requirements of ANSI B30.5 (2000). Structure and stability have been tested in accordance with SAE J1063 and SAE J765, respectively. Modifications to the crane or use of optional equipment other than specified by the manufacturer can result in a reduction of capacity.
- The main boom and auxiliary boom head lifting capacities are determined by boom length and load radius. The extension and jib lifting capacities are determined by boom angle.
- Rated capacity loads given are maximum covered by the manufacturer's warranty and are based on a freely suspended load with NO allowance for factors such as out-of-level operation, supporting surface conditions, hazardous surroundings, experience of personnel, etc. The operator shall establish practical working loads based on prevailing operating conditions, such as, but not limited to the above.
- All rated capacity loads shown apply to original equipment as supplied by SpanDeck, Inc.
- All rated capacity loads appearing above the bold line are based on structural strength; tipping should not be relied upon as a capacity limitation.
- All rated capacity loads appearing below the bold line are based on stability and do not exceed 75% of tipping.
- Deductions from rated capacities must be made for the weight of the hook block, headache ball, slings, spreader bar, and any other suspended equipment. See Lifting Capacity Deduction Chart for load handling devices supplied by SpanDeck, Inc.
- A properly calibrated and maintained Load Moment Indicator (LMI) system will indicate boom mounted and other suspended equipment.
- When making lifts where capacities may be within a zone limited by structural strength, the operator shall determine that the weight of the load is known within plus or minus (+/-) ten percent (10%) before making lift.
- It is permissible to attempt to telescope boom with a load within the limits of rated capacities. However, boom telescope system hydraulic pressure, and/or boom lubrication may affect operation.
- Side pull on boom is extremely dangerous and must be avoided.
- DO NOT** exceed manufacturers maximum specified reeving.
- DO NOT** lift load or extend boom without proper configuration of crane per load chart selected.
- DO NOT** attempt to lift any load when wind speed exceeds 20 mph.

Load moment indicating and anti-two block systems are operator aids and must never be used in lieu of job site lift planning calculations by the operator which must take into account ground conditions, weather and all other environmental factors prevailing at the time of the lift. Prices and specifications are subject to change at any time without prior notice and are for factory installation at the time of original manufacture. F.O.B Plant; Richlands, VA 24641. Illustrations and photographs may show optional equipment. Supercedes all previous issues. Please see www.mantiscranes.com for most current information.



THESE CHART VALUES ARE ONLY A GUIDE AND MUST NOT BE USED TO OPERATE THE CRANE. USE ONLY THE IN CAB LOAD CHARTS AND OPERATOR'S MANUAL FURNISHED WITH THE CRANE.

MANTIS® PRODUCT LINE

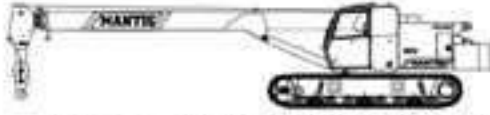

3612 - 18 US TON CRAWLER



9010 - 45 US TON CRAWLER

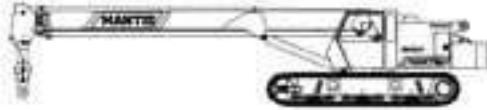

3612LP - 18 US TON CRAWLER

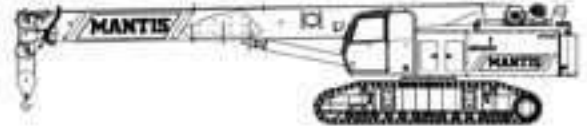

10010Mx - 50 US TON CRAWLER



6010 - 30 US TON CRAWLER

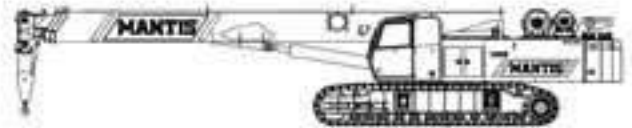

14010 - 70 US TON CRAWLER

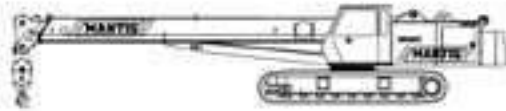

6010LP - 30 US TON CRAWLER

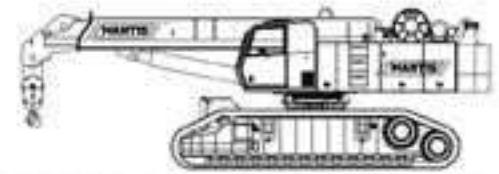

200RS - 100 US TON CRAWLER

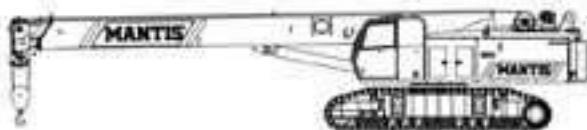

8012 - 40 US TON CRAWLER

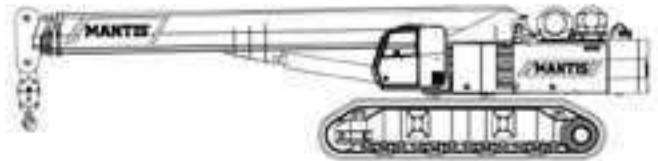

20010 - 100 US TON CRAWLER

MANTIS CRANES

Mfg. by SpanDeck, Inc.

129 CONFEDERATE DRIVE • FRANKLIN, TN 37064 USA

PHONE: 800-272-3325 • FAX: 615-790-6803

sales@mantiscranes.com • www.mantiscranes.com

