



MARCHETTI
autogru spa



CW 45.32L



GRU TELESCOPICA SU CINGOLI
TELESCOPIC CRAWLER CRANE
GRUE TELESCOPIQUE SUR CHENILLES
TELESCOP-RAUPENKRAN

<https://cranemanuals.com>

MARCHETTI
autogru spa

CW45.32L



<https://cranemanuals.com>



3

1. Semplicità di trasporto
Easy transport
2. Immediata operatività
Immediate lifting readiness
3. 32m di braccio disponibilit su ogni terreno
32m boom in any condition





MARCHETTI
autogru spa

CW45.32L

Dimensioni (mm) / Dimensions (mm) / Encombrement (mm) / Maße (mm)

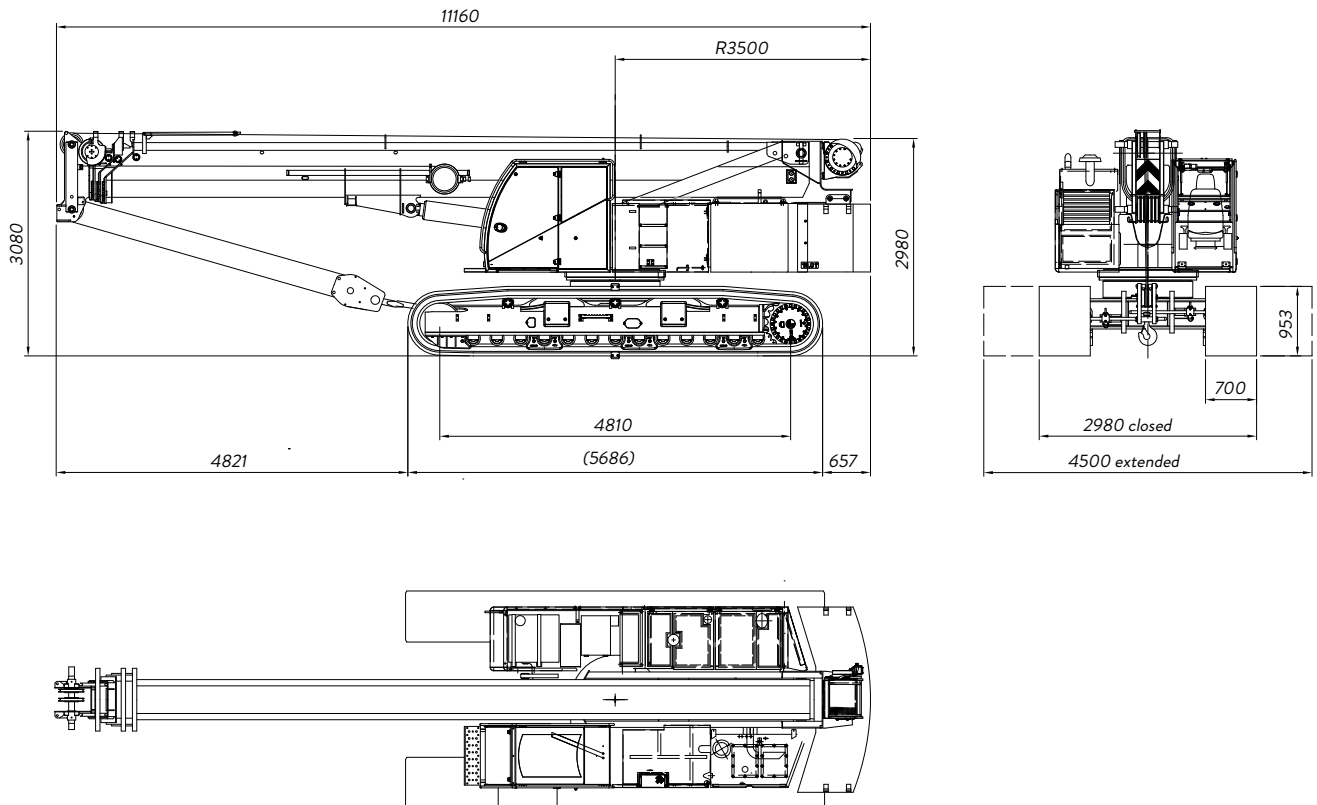

Pesi / Weights / Poids / Gewichte

Zavorra
Counterweight
Contrepoid
Ballast



10 t

0 t

Massa totale
Total weight
Poids total
Gesamtgewicht

(*)



41000 kg

31000 kg

Pressione spec.
Ground pressure
Pression au sol
Bodenpressung

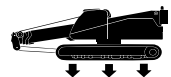

0,60 Kg/cm²

0,46 Kg/cm²





(*) Incluso bozzello standard 30t / Including 30t hook block / Avec crochet standard 30 t / Mit standard Haken 30t.

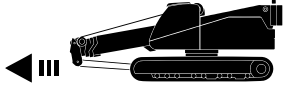
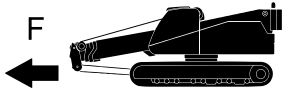
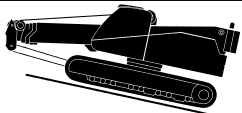

Prestazioni del carro / Undercarriage performance / Performances / Wagon leistung

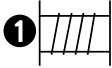
	Velocità Speed Vitesse Geschwindigkeit	0-2.6 km/h
	Forza di trazione massima Max driving force Effort maxi de traction Maximale Vortriebskraft	380 kN
	Pendenza superabile Gradeability Pente surmontable Steigungswinkel	70%

Prestazioni della gru / Crane performances / Performance de la grue / Geschwindigkeiten

	Infinitamente variabile Infinitely variable Infinement variable Stufenlos	Fune: diametro/ lunghezza Rope: diameter/length Câble : diam/longueur Seil: Durchmesser/Länge	Sforzo max sulla fune Max single line pull Effort maxi sur le câble Max Seilzug
	0-100 m/min	14 mm / 140 m	36 kN
	0-100 m/min	14 mm / 140 m	36 kN
	0-2 min ⁻¹		
	10 m - 32 m : 90 s		
	0° - 80° : 45 s		

Bozzelli / Hook blocks / Moufles / Blöche

Tipo / Type Type / Typ	Carrucole / Sheaves Poulies / Rollen	Taglie / Lines Brins / Strange	Peso / Weight Poids / Gewicht (Kg)
40 t	5	11	350
30 t	4	9	280
12 t	1	2	170
8 t	0	1	110



MARCHETTI
autogru spa

CW45.32L

Altezze di sollevamento / Maximum tip height / Hauteurs de levage / Hubhöhen



10-32 m



3,8 m



360°



10 t

DIN
ISO









Tabella di portata / Load charts / Tableaux des charges / Traglasttabelle

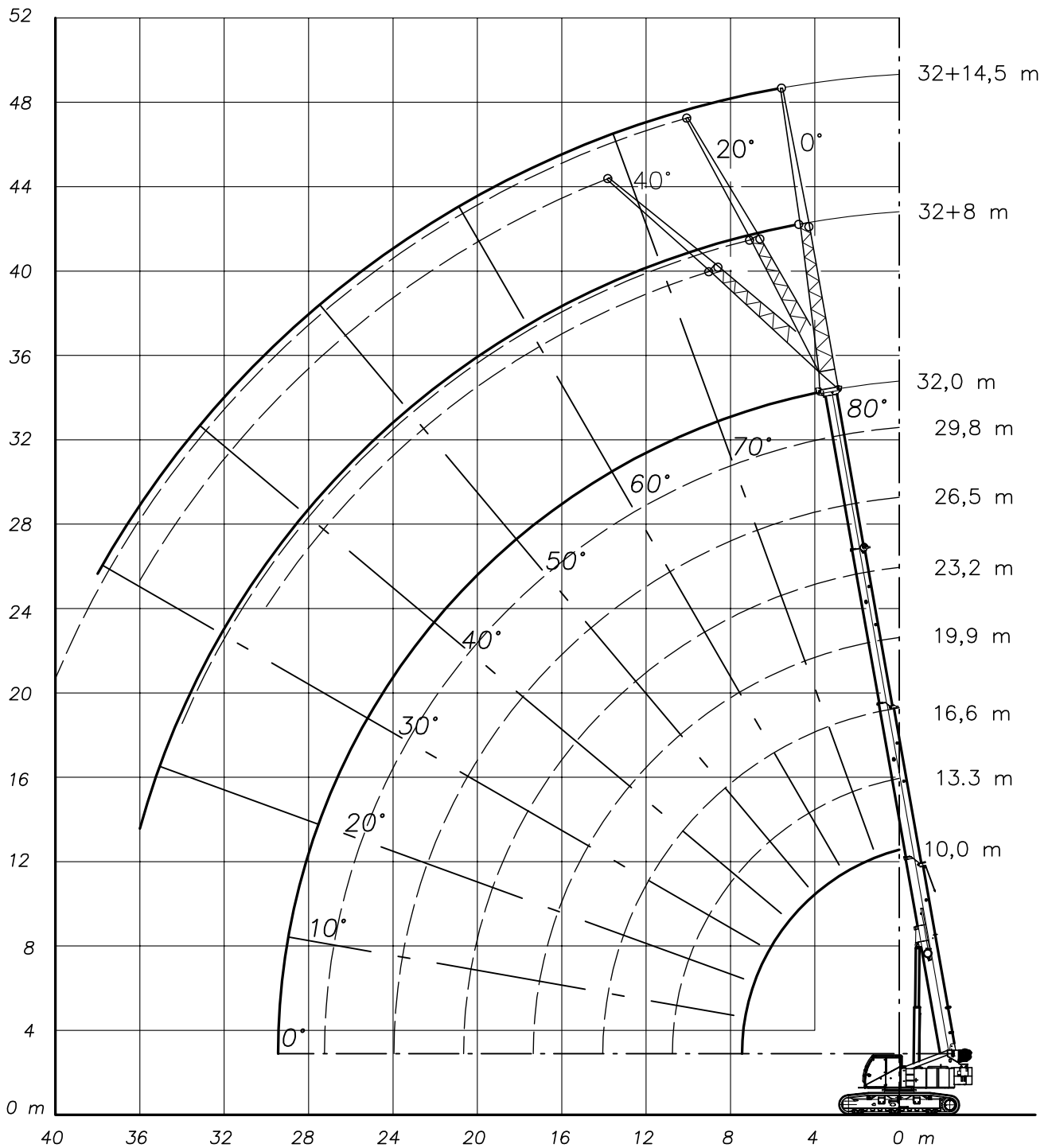
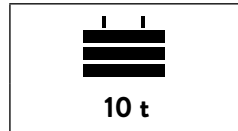
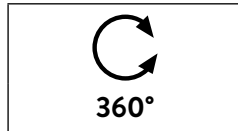
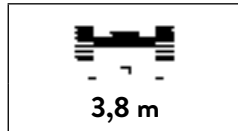

	10,0	13,3	16,6	19,9	23,2	26,5	29,8	32,0	
	t	t	t	t	t	t	t	t	
2,0	45								2,0
2,5	40,0								2,5
3,0	36,1	17,5	17,1	16,5					3,0
3,5	34,0	17,5	17,1	16,5	16,0				3,5
4,0	32,0	17,5	17,1	16,5	16,0	10,8			4,0
5,0	26,0	17,5	17,1	16,4	16,0	10,8	7,8		5,0
6,0	19,0	17,5	17,1	16,0	15,8	10,6	7,8	7,0	6,0
7,0	14,7	15,0	15,2	14,6	14,0	10,4	7,8	7,0	7,0
8,0		12,2	12,4	12,4	12,0	10,2	7,8	7,0	8,0
9,0		10,1	10,3	10,4	10,4	10,0	7,7	6,8	9,0
10,0		8,5	8,7	8,8	8,9	8,9	7,6	6,5	10,0
12,0			6,5	6,6	6,7	6,8	6,8	6,1	12,0
14,0			5,0	5,2	5,2	5,3	5,3	5,3	14,0
16,0				4,1	4,2	4,2	4,3	4,3	16,0
18,0					3,4	3,4	3,5	3,5	18,0
20,0					2,7	2,8	2,8	2,9	20,0
22,0						2,3	2,3	2,4	22,0
24,0							1,9	2,0	24,0
26,0							1,6	1,6	26,0
28,0								1,1	28



MARCHETTI
autogru spa

CW45.32L

Table di portata / Load charts / Tableaux des charges / Traglasttabelle



10 - 23,2 m



3,8 m V=1 km/h







360°



10 t

DIN
ISO

 m	10,0	13,3	16,6	19,9	23,2	 m
 t						 t
3,0	30,0	14,0	13,7	13,2		3,0
3,5	27,2	14,0	13,7	13,2	12,8	3,5
4,0	25,6	14,0	13,7	13,2	12,8	4,0
5,0	23,6	14,0	13,7	13,1	12,8	5,0
6,0	17,2	14,0	13,7	12,8	12,6	6,0
7,0	13,3	13,6	13,0	12,4	12,3	7,0
8,0		11,0	11,2	11,3	11,4	8,0
9,0		9,1	9,3	9,4	9,5	9,0
10,0		7,7	7,9	8,0	8,0	10,0
12,0			5,9	6,0	6,0	12,0
14,0			4,5	4,6	4,7	14,0
16,0				3,7	3,7	16,0
18,0					3,0	18,0
20,0					2,4	20,0
22						22



10 - 16,6 m



2,28 m V=1 km/h



360°



10 t

DIN
ISO















 m	10,0		13,3		16,6		 m
	0°	360°	0°	360°	0°	360°	
 t							 t
3,0	30,0	16,0	14,0	14,0	13,7	12,5	3,0
3,5	27,2	16,0	14,0	14,0	13,7	12,5	3,5
4,0	25,6	16,0	14,0	14,0	13,7	12,5	4,0
5,0	23,6	13,4	14,0	13,6	13,7	12,5	5,0
6,0	17,2	10,1	14,0	10,4	13,7	10,5	6,0
7,0	13,3	7,9	13,6	8,2	13,0	8,4	7,0
8,0			11,0	6,7	11,2	6,8	8,0
9,0			9,1	5,5	9,3	5,7	9,0
10,0			7,7	4,6	7,9	4,8	10,0
12,0					5,9	3,5	12,0
14,0					4,5	2,6	14,0

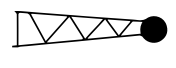

Tabella di portata della prolunga tralicciata / Load charts on the folding jib / Tableaux des charges a la fléchette pliante / Traglasttabelle am Klappspitze

 32 m	 8/14,5 m	 3,8 m	 360°	 10 t	DIN ISO
--	--	---	--	--	----------------

 m	32 + 8 m			32 + 14,5 m			 m
	0°	20°	40°	0°	20°	40°	
 m ₁	t			t			 m ₁
	8,0	2,7			1,5		
10,0	2,7	2,3		1,4			10,0
12,0	2,7	2,2	1,7	1,4	1,2		12,0
14,0	2,7	2,1	1,6	1,3	1,2		14,0
16,0	2,6	2,0	1,6	1,3	1,1	0,8	16,0
18,0	2,5	1,9	1,5	1,2	1,1	0,8	18,0
20,0	2,4	1,8	1,5	1,2	1,0	0,8	20,0
22,0	2,2	1,7	1,5	1,1	0,9	0,8	22,0
24,0	1,8	1,7	1,4	1,0	0,8	0,7	24,0
26,0	1,4	1,6	1,4	1,0	0,8	0,7	26,0
28,0	1,2	1,3	1,3	0,9	0,7	0,7	28,0
30,0	0,9	1,0	1,0	0,9	0,7	0,6	30,0
32,0	0,7	0,8		0,8	0,7	0,6	32,0
34,0	0,5	0,6		0,6	0,7	0,6	34,0
36,0	0,3			0,4	0,6	0,6	36,0
38,0					0,4		38,0

IT

- I carichi indicati rispettano la norma EN13000.
- La gru può lavorare con velocità del vento corrispondente a 5 e 7 Beaufort, in funzione della lunghezza del braccio.
- I pesi dei ganci e di tutti gli accessori per l'imbracatura fanno parte del carico e devono essere dedotti dai carichi indicati.
- I carichi indicati per il braccio principale sono intesi con prolunga tralicciata e falcone smontati.
- I carichi sono indicati in tonnellate metriche.
- I raggi di lavoro sono calcolati a partire dall'asse di rotazione della torretta.
- Carichi superiori a 52,1 t eseguibili solamente con equipaggiamento supplementare.

EN

- The lifting capacities are based on EN13000.
- Crane operation is permissible up to wind corresponding to 5 and 7 Beaufort depending on boom length.
- Working radii are measured from the slewing centerline.
- Weight of hook blocks and slings is part of the load, and must be deducted from the capacity ratings.
- The lifting capacities given for the telescopic boom only apply if the folding jib and jib are dismantled.
- Lifting capacities are given in metric tons.
- Lifting capacities above 52.1 t only with special equipment.

FR

- Les charges indiquées respectent EN13000.
- La structure de la grue est calculée selon les normes DIN 15018 partie 3 et FEM 5004.
- La grue peut travailler jusqu'à une vitesse du vent correspondant à 5 et 7 Beaufort en fonction de la longueur de flèche.
- Les poids du crochet-moufle et de tous les accessoires d'élingage font partie de la charge et sont à déduire des charges indiquées.
- Les forces indiquées pour la flèche télescopique s'entendent fléchette dépliée et fléchette démontée.
- Les forces de levage sont données en tonnes.
- Les portées sont calculées à partir de l'axe de rotation de la plateforme.
- Les charges supérieures à 52,1 t seulement avec équipement supplémentaire

DE

- Die angegebenen Lasten entsprechen der Norm EN13000.
- Der Kran kann bei einer Windgeschwindigkeit von 5 bis 7 Beaufort laufen, in Abhängigkeit von der Länge des Armes.
- Die Gewichte der Haken und das ganze Zubehör der Hebeseile sind Teil der Belastung und müssen ab den angegebenen Belastungen abgezogen werden.
- Die angegebenen Belastungen für den Hauptausleger sind mit Gittermast-Verlängerungsschnur ausgestattet.
- Die Belastungen werden mit Tonnen angezeigt.
- Arbeitsradius wird vom Zentrum des Kugeldrehkranses gerechnet.
- Belastungen über 52,1 Tonnen nur bei Extra-Ausrüstung.



MARCHETTI
autogru spa

CW45.32L

Descrizione tecnica / Technical description

IT

CARRO

Telaio centrale ad elevata rigidità con due fiancate cingolate ad apertura idraulica (carreggiata variabile). Bielle di bloccaggio carreggiata. Suole standard a 3 barre da 700mm.

Trazione indipendente dei 2 cingoli azionata da riduttori epicicloidali con freno negativo e motori idraulici a pistoni a cilindrata variabile. Possibilità di contro rotazione. N.2 pedane di salita.

MOTORE

Livello Emissioni Stage 5:

Diesel Perkins, 4 cilindri turbo intercooler, common rail, 129kW@2200rpm, 750Nm@1400rpm. Post-trattamento fumi DOC+DPF+SCR.

Serbatoio Ad-blue 17,4 lt. Serbatoio gasolio da 210 lt. Livello Emissioni Stage 3a: disponibile a richiesta
Motore Volvo Stage 5: disponibile a richiesta.

IMPIANTO IDRAULICO

Di tipo "load sensing" con una pompa a cilindrata variabile a pistoni assiali e regolazione di potenza, per l'azionamento della gru. Una pompa ad ingranaggi per l'azionamento della rotazione. Possibilità di azionamento di 4 manovre contemporanee. N.2 manipolatori elettronici per il comando della gru. N.2 pedipolatori idraulici per il comando dei cingoli. Serbatoio olio 700 l. Raffreddamento dell'olio idraulico.

IMPIANTO ELETTRICO

Sistema elettronico canbus. Impianto elettrico 24 Vdc con n.2 batterie in serie da 120 Ah. N.4 fari di lavoro a led.

ROTAZIONE

Riduttore epicicloidale con freno automatico a molla. Motore orbitale e valvola di frenatura. Ralla a due giri di sfere, dentatura esterna. Bloccaggio manuale per il trasporto.

ARGANO

Riduttore epicicloidale con freno automatico a molla. Motore a pistoni. Tamburo scanalato. Fune diametro 14 mm. Tiro massimo 36 kN.

BOZZELLO

Bozzello a 4 carrucole, tipo 30 t

SOLLEVAMENTO BRACCIO

N.1 cilindro idraulico diff. con valvola di controllo discesa pilotata.

BRACCIO

Telescopico in acciaio ad alta resistenza a 4 sezioni: 1 elemento di base, 3 elementi a sfilo sincronizzato. Sfilamento sotto carico parziale. Lunghezza del braccio: 10 m - 32 m.

ZAVORRA

Massa totale 10 t, spinata alla torretta.

DISPOSITIVI DI SICUREZZA

Valvole di massima pressione su tutte le funzioni idrauliche. Valvole di blocco e di controllo sui cilindri e motori idraulici. Limitatore di momento. Controllo posizione dei cingoli. Fine corsa in salita e discesa del bozzello. Indicatore di carico a 3 luci (semaforo). Cicalino. Lampeggiante. Estintore.

EN

UNDERCARRIAGE

Torsion resistant box construction frame with extendable crawler carriers (variable track) and locking rods. Standard 700mm triple grouser shoes.

Crawler traction with two epicycloidal reducers with automatic spring brake and variable displacement hydraulic piston motors. Counter-rotation available. N.2 footboard.

ENGINE

Emission Level Stage 5:

Diesel Perkins, 4 cylinders, water cooled, turbocharged.

Max power 129 kW @ 2200 rpm, max torque 750 Nm @1400 rpm.

DOC+DPF+SCR exhaust after treatment. Ad-blue tank 19 l. Fuel tank 210 l.

Emission level Stage 3a: available upon request

Stage 5 Volvo engine: available upon request.

HYDRAULIC SYSTEM

Load sensing hydraulic system with 1 x piston pump for crane's operation and 1 x gear pump for slewing and service circuits. Possibility of activating 4 contemporary maneuvers. N.2 proportional electronic joysticks for crane control. N.2 hydraulic pedals for crawler control. Oil tank 700 l. Oil heat exchanger.

ELECTRIC SYSTEM

Canbus data system. Electrical system 24 Vdc, with n.2 batteries in series 120 Ah. N.4 led working lights.

SLEWING

Continuous 360° slewing achieved by epicyclic reducer with automatic multiple discs brake in oil bath. Heavy duty slew ring with double ball rim and external geared ring. Manual locking for transport position.

HOIST GEAR

Grooved drum. Hydraulic piston motor, epicyclic reducer and automatic multiple disk brake in oil bath. Cable diameter 14 mm, hoisting capacity at the 4th layer 36 kN.

HOOK BLOCK

Type 30 ton hook block, 4 sheaves, ram horn type.

BOOM ELEVATION

Differential hydraulic cylinder equipped with piloted load control valve.

BOOM

4-section telescopic boom, length ranging from 10 m to 32 m, full hydraulic extension (1 x base section, 3 x synchronized telescopic sections). Maximum height from ground approximately 34 m.

COUNTERWEIGHT

Total 10 t, pinned to the superstructure.

SAFETY DEVICES

Lifting hoist limit switch, safety and pressure valves, emergency stop device and electronic moment limiter device. Crawler track monitoring.

3-color warning signal light positioned on the front. Buzzer. Rotating light. Fire extinguisher.



Description technique / Technische Eigenschaften

FR

CHASSIS CHENILLES

Châssis central à haute rigidité avec deux côtés de chenilles à ouverture hydraulique (voie variable). Tuiles standard à 3 nervures de 700 mm de large. Traction de deux chenilles indépendante. Entraînement des chenilles au moyen de moteurs hydrauliques à cylindrée variable et pistons axiaux, réducteurs planétaires et frein négatif. Possibilité de contre-rotation. Deux plate-forme pour monter.

MOTEUR

Niveau d'émissions Stage 5:
Perkins, 4 cylindres turbo intercooler, refroidi à eau, 129 kW@2200 rpm, 750 Nm@1400 rpm. Réservoir Ad Blue de 19 l, réservoir gasoil de 200 litres. Traitement post-combustion avec DOC + DPF+SCR.
Niveau d'émissions Stage 3a: disponible sur demande
Moteur Volvo Stage 5 disponible sur demande.

SYSTEME HYDRAULIQUE

Système hydraulique "load sensing" avec une pompe à débit variable à pistons axiaux pour les entraînements de la grue. Une pompe à engrenages pour l'orientation. Possibilité d'exécuter 4 manœuvres en même temps. Deux levier de commande à 4 positions. Le train de chenilles est actionné par 2 pédales. Réfrigérant hydraulique. Réservoir huile de 700L

SYSTEME ELECTRIQUE

24V DC. No 2 batteries de 120Ah. Quatre phares de travail à LED.

ORIENTATION

Réducteur planétaire avec frein d'arrêt commande par ressort. Moteur orbital et soupape de freinage. Couronne à deux rangs de billes avec denture externe.

TREUIL

Avec moteur à pistons, réducteur planétaire avec frein d'arrêt commande par ressort, tambour cannelé. Câble de 14 mm effort maxi 36 kN.

MOUFLE

Moufle à 4 poulies avec capacité 30 t.

LEVAGE DE LA FLECHE

N.1 vérin hydraulique avec valve de contrôle de descente.

FLECHE

Flèche télescopique à 4 éléments de longueur allant de 10 m à 32 m, télescopage entièrement hydraulique. Un élément de base, trois éléments à télescopage synchronisée. Hauteur du sol: environ 34 m. Possibilité de télescopage sous charge partiel.

CONTREPOIDS

Masse totale 10 tonnes accroché à la tourelle.

SÉCURITÉ

Valves de sécurité et limiteurs de pression sur toutes les fonctions hydrauliques. Valves de bloc et de contrôle sur les vérins et les moteurs hydrauliques. Contrôleur de charge. Contrôleur de la position des chenilles. Dispositifs d'avertissement acoustique et lumineux. Dispositif de limitation de course en montée et descente du moufle. Extincteur.

DE

RAUPENFAHRZEUG

Qualitätsfahrwerk mit hoher Steifigkeit, variable, hydraulisch verstellbare Breite. Ketten mit 700 breiten Gliedern. Die zwei Raupen sind unabhängig steuerbar. Sie werden von Planetengetrieben mit hydraulischen Hubkolbenmotoren mit variablem Hubraum angetrieben. Gegenläufige Rotation ist möglich. No. 2 Plattformen klettern.

MOTOR

Emissionen nach Abgasstufe 5
Perkins, 4 Zylinder Diesel Common Rail Turbo-intercooler, Wasserkühlung, mit DOC, +DPF+SCR, 129 Kw@2200 rpm, 750 Nm@1400 rpm. AdBlue Tank 19 l, Dieseltank 210L
Emissionsniveau Stage 3a: auf Anfrage
Emissionsniveau Stage 5 Volvo: auf Anfrage

HYDRAULIKANLAGE

Anlage des Typs "Load Sensing". Eine Verstellpumpe mit Axialkolben für den Antrieb der Raupenkettens/des Krans, Eine Zahnradpumpen für den Antrieb der Rotation und der Betriebsfunktionen. Es können bis zu 4 Manöver gleichzeitig ausgeführt werden. Zwei Steuerhebel zur Kransteuerung. Zwei Pedale/Hebel zur Traktionssteuerung. Kühlung des Hydrauliköls, Öltank 700L

ELEKTRISCHEANLAGE

CANBUS, 24 Volt Gleichstrom, 2 Batterien mit je 120 Ah, 4 LED Arbeitsscheinwerfer.

ROTATION

Planetengetriebe mit automatischer federbelasteter Bremse. Orbimotoren und Bremsventil. Doppel-Kugeldrehkranz. Manuelle Block für den Transport.

HUBWERK

Planetengetriebe mit automatischer federbelasteter Bremse. Kolbenmotor. Nuttrommel. Seil Durchmesser 14 mm. Maximale Seilzug 36 kN.

HAKEN

Hakenflasche mit 4 Rollen, Typ 30t.

WIPPWERK

1 Diff. Hydraulikzylinder mit gesteuertem Abstiegssteuerventil

TELESKOP AUSLEGER

aus Stahl mit hoher Widerstandsfähigkeit, 1 Basiselement, 3 synchrone Verlängerungen. Auszug unter Teillast
Länge des Auslegers: 10 - 32 m.

BALLAST

1 Stück 10 t an den Turm gehakt.

SICHERHEITSVORRICHTUNGEN

Sicherheitsdruckventil für alle hydraulischen Funktionen. Absperr und Steuerventile auf den hydraulischen Zylindern und Motoren. Lastbegrenzer. Endanschlag bei Hub und Senkung des Hakens. Blinkender Summer. Feuerlöscher.



Cabina / Cab / Cabine / Kabine



IT Cabina climatizzata con visibilità a 360° e vetri di sicurezza. Sedile ergonomico riscaldato con sospensione pneumatica, supporto lombare e possibilità di regolazioni multiple. Manipolatori ergonomici integrati nel sedile e monitor a colori da 10".

EN Air conditioning cab with 360° visibility and safety glass, Self-heated ergonomic seat with pneumatic suspension, lumbar support and possibility of multiple adjustments, ergonomic manipulators integrated into the seat and 10" colour display.

FR Cabine climatisée avec visibilité à 360°, et vitres de sécurité. Siège chauffant ergonomique avec suspension pneumatique, support lombaire et possibilité de réglage multiples. Manipulateurs ergonomiques intégrés au siège et écran couleur 10".

DE Klimatisierte Kabine mit 360° Sicht und Sicherheitsglas, Ergonomisch beheizter Sitz mit Luftfederung, Lordosenstütze und Mehrfachverstellung. Ergonomischer Manipulatoren im Sitz und 10 Zoll Farbmonitor.

Accessori / Optional / Equipement en option / Optionen

IT

- Riscaldamento Webasto
- Suole piatte
- Argano ausiliario
- Prolunga telescopica con lunghezza 8/14.5 m ripiegabile a lato del braccio, inclinazione 0°/20°/40°
- Jib 1.3 m.
- Testina ripiegabile per tiro diretto (max 3.5ton)
- Piattaforma aerea
- Radiocomando
- Videocamere
- Bozzelli di varie portate.
- Limitatore area di lavoro per operare in sicurezza in ambienti ristretti,
- Piattaforma per accesso remoto, localizzazione GPRS.
- Altri a richiesta.

EN

- Webasto heater
- Flat rack shoes
- Auxiliary winch.
- 8/14.5 m jib (0°-20°-40° adjustable) stowable alongside boom
- Jib 1.3m
- Foldable Rooster Head for direct pull (max 3.5tons);
- Elevated working platform
- Remote controller
- Cameras
- Additional Hooks;
- Working Area Limiter for safe operation in restricted areas;
- Remote access platform including GPRS localization etc.
- Others upon request

FR

- Tuiles plates.
- Treuil auxiliaire.
- Extension télescopique de 8/14.5 m repliable sur la flèche base, inclinaison 0° / 20° / 40°
- Jib 1.3 m.
- Tête pliable pour traction directe (max 3,5 tonnes)
- Plateforme aérienne
- Télécommande
- Caméras
- Mouflés de différents capacités.
- Limiteur de zone de travail pour fonctionner en toute sécurité dans des espaces confinés,
- Application d'accès à distance, localisation GPRS
- Autres sur demand

DE

- Heizung Webasto
- Flachbodenplatten
- 2Winde
- Teleskopverlängerung von 8/14.5 m Länge, seitlich am Ausleger zusammenklappbar, Neigung 0° / 20° / 40°
- Spitzenausleger 1.3 m
- Schnabelausleger (max. 3,5 t)
- Hubarbeitsbereich
- Fernbedienung
- Kameras
- Blöcke verschiedener Tragkraft.
- Arbeitsbereichsbegrenzer für den sicheren Betrieb auf engstem Raum,
- Fernzugriffsanwendung, GPRS-Lokalisierung
- Zusätzliches Zubehör auf Anfrage





Note

A large rectangular area containing 25 horizontal lines, intended for taking notes.



Via Caorsana 49 - 29122 Piacenza - Italy

Tel. ++39/0523/573711

Fax ++39/0523/593253

Web: www.marchetti.it

E-Mail: mark@marchetti.it / info@marchetti.it



LinkedIn



YouTube



Per il costante miglioramento del prodotto, dati e caratteristiche tecniche possono variare a nostro giudizio senza alcun obbligo di preavviso.

Le informazioni riportate sono solo a titolo indicativo. La messa in servizio della macchina richiede l'osservanza del manuale d'Uso e delle tabelle di portata fornite con la macchina.

In accordance with our policy of constant improvement, we reserve the right to amend this specification at any time without notice.

Data published in this brochure is to be intended as a guide; crane operation is subject to the observance of the Use & Maintenance manual and the Lifting Charts supplied with the machine.

Suivant notre politique d'amélioration, nous nous réservons le droit de modifier sans préavis certaines des caractéristiques indiquées dans cette notice.

Les renseignements ci-inclus, sont donnés à titre d'exemple; la mise en service de la machine est autorisée à condition que le manuel d'Utilisation et d'Entretien et les Tableaux de Charges fournies soient observés.

Aufgrund der ständigen Weiterentwicklung des Produkts behalten wir uns das Recht vor, die technischen Daten und Eigenschaften ohne Vorankündigung zu ändern.

Die aufgeführten Informationen dienen nur zur Orientierung. Bei der Inbetriebnahme der Maschine müssen die Bedienungsanleitung und die Traglasttabellen beachtet werden.

<https://cranemanuals.com>