

# MG 70.4 S

Autogru multistrada

All terrain crane

Grue tout terrain



 MARCHETTI

<https://cranemanuals.com>

**Dimensioni   Dimensions   Encombrements**

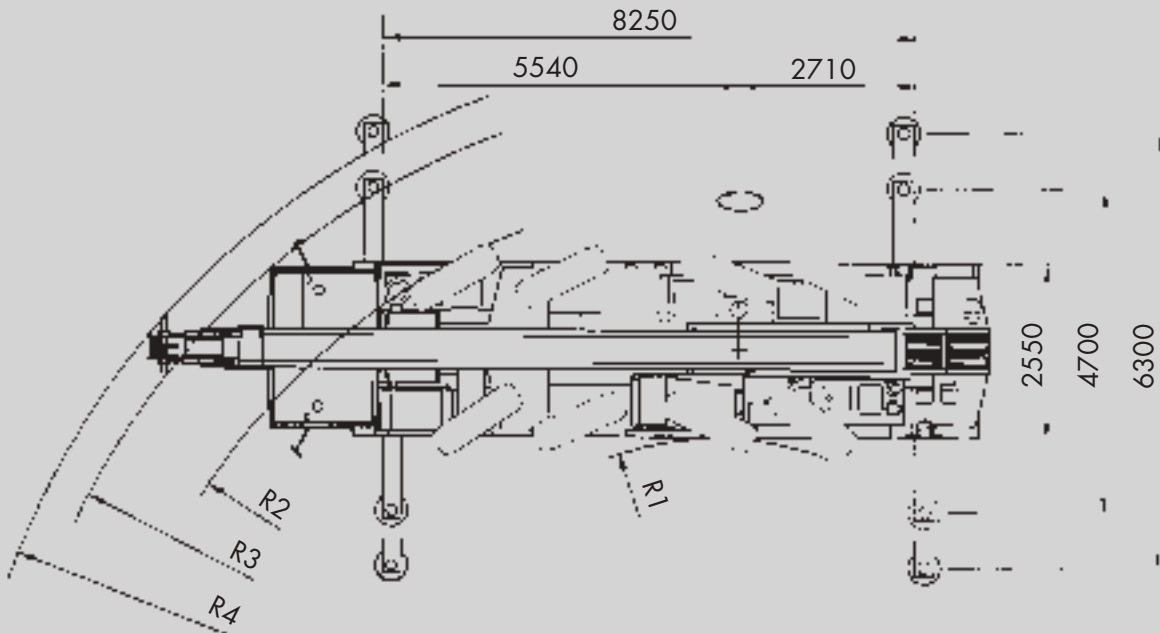
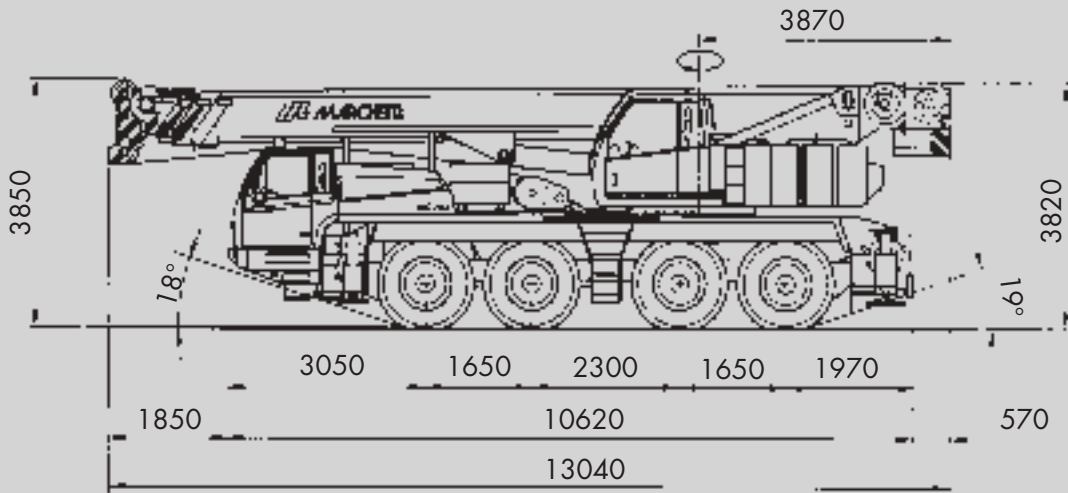

Pneumatici Tyres/Pneus	R1	R2	R3	R4
<b>16.00 R25</b>	7800	11500	13050	13550

Pneumatici Tyres/Pneus	R1	R2	R3	R4
<b>16.00 R25</b>	4550	8000	9500	10200



su strada / on road  
sur route



tutte le ruote sterzate  
all wheels steering  
toutes roues braquées



## Caratteristiche tecniche del carro

### TELAIO

Fabbricazione Marchetti, in lamiera d'acciaio ad alta resistenza, costruzione a cassone resistente alla torsione.

### STABILIZZATORI

4 travi telescopiche, azionate idraulicamente. Comandi indipendenti per ogni movimento dalla cabina di manovra e dai due lati del carro.

### MOTORE

Iveco mod. C10 ENT, Diesel turbo intercooler, Euro Mot 3A, raffreddato ad acqua, sei cilindri in linea.  
Potenza max: 265 kW (361 CV) a 2100 giri/min.  
Coppia max: 1700 Nm a 1400 giri/min.

### CAMBIO

Automatico ZF 6HP600, 6 marce avanti + retromarcia, con retarder.

### RIDUTTORE

A 2 rapporti: con differenziale ripartitore bloccabile.

### ASSI

1°-2°-3°-4° sterzanti. 1°-3°-4° trainanti. Bloccaggio dei differenziali.

### SOSPENSIONI

Idropneumatiche con bloccaggio, possibilità di regolazione della altezza macchina, regolazione trasversale. Corsa dei cilindri: 220 mm. Dispositivo di autolivellamento automatico.

### PNEUMATICI

Semplici su tutti gli assi, misura: 16.00 R 25.

### STERZO

Idroguida ZF a doppio circuito. Pompa di emergenza sulla trasmissione. 4 assi sterzanti. 4 possibili combinazioni di sterzata.

### FRENI

Freno di servizio: pneumatico a 3 circuiti agente su tutte le ruote.

Freno di soccorso: incorporato nel freno di servizio.

Freno di stazionamento: a molla con comando pneumatico, agente sul 3° e 4° asse.

Freno rallentatore idraulico sul cambio (retarder).

### CABINA DI GUIDA

Ribaltabile a 2 posti con sedili ammortizzati, insonorizzata, con strumentazione completa e riscaldamento. Pompa elettrica per sollevamento del braccio in caso di avaria al motore.

### IMPIANTO ELETTRICO

24 Volts, 2 batterie da 155 Ah.

## Caratteristiche tecniche della torretta

### PIATTAFORMA

In lamiera d'acciaio ad alta resistenza strutturale e torsionale.

### IMPIANTO OLEODINAMICO

4 pompe alimentano 4 circuiti indipendenti e interconnessi, possibilità di 3 manovre contemporanee.

### ARGANO

Tamburo scanalato, con riduttore epicicloidale e freno a dischi automatico, motore a pistoni e valvola di controllo.

### SOLLEVAMENTO

Un cilindro a doppio effetto con valvola di regolazione e blocco.

### ROTAZIONE

Riduttore epicicloidale con freno a dischi automatico, motore idraulico con valvola di controllo.

### CABINA DI MANOVRA

Ampia visibilità, con sedile regolabile e riscaldamento, completa di comandi e di strumentazione anche per la traslazione.

### BRACCIO

Telescopico a sezione ottagonale in acciaio ad altissima resistenza. Un elemento base, 1° prolunga idraulica indipendente, 2°, 3°, 4° prolunghe idrauliche sincronizzate. Sfilamento sotto carico parziale.

### ZAVORRA DA 11,6 t

Composta da più pezzi componibili, movimentabili idraulicamente con comando dalla cabina.

### DISPOSITIVI DI SICUREZZA

Dispositivo fine corsa sulla salita e discesa, valvole di sicurezza, valvole di sovrappressione.

Limitatore elettronico di momento.

## Accessori a richiesta

- ARGANO AUSILIARIO
- PROLUNGA TRALICCIATA da 4,5 m ripiegabile a lato del braccio.
- PROLUNGA TRALICCIATA da 10.1 m a 17.1 m inclinabile e ripiegabile a lato del braccio.
- TESTINA RIPIEGABILE per tiro diretto.
- ZAVORRA SUPPLEMENTARE da 4,5 t
- BOZZELLI di varie portate.
- RUOTA DI SCORTA.
- Altri equipaggiamenti accessori a richiesta.

## Omologazioni

L'Autogru MG 70.4 S è conforme alla direttiva europea 98/37/CE. È omologata come autoveicolo ad uso speciale (categoria autogru) o come macchina operatrice eccezionale.

**Altezze di sollevamento Maximum tip height Hauteurs de levage**

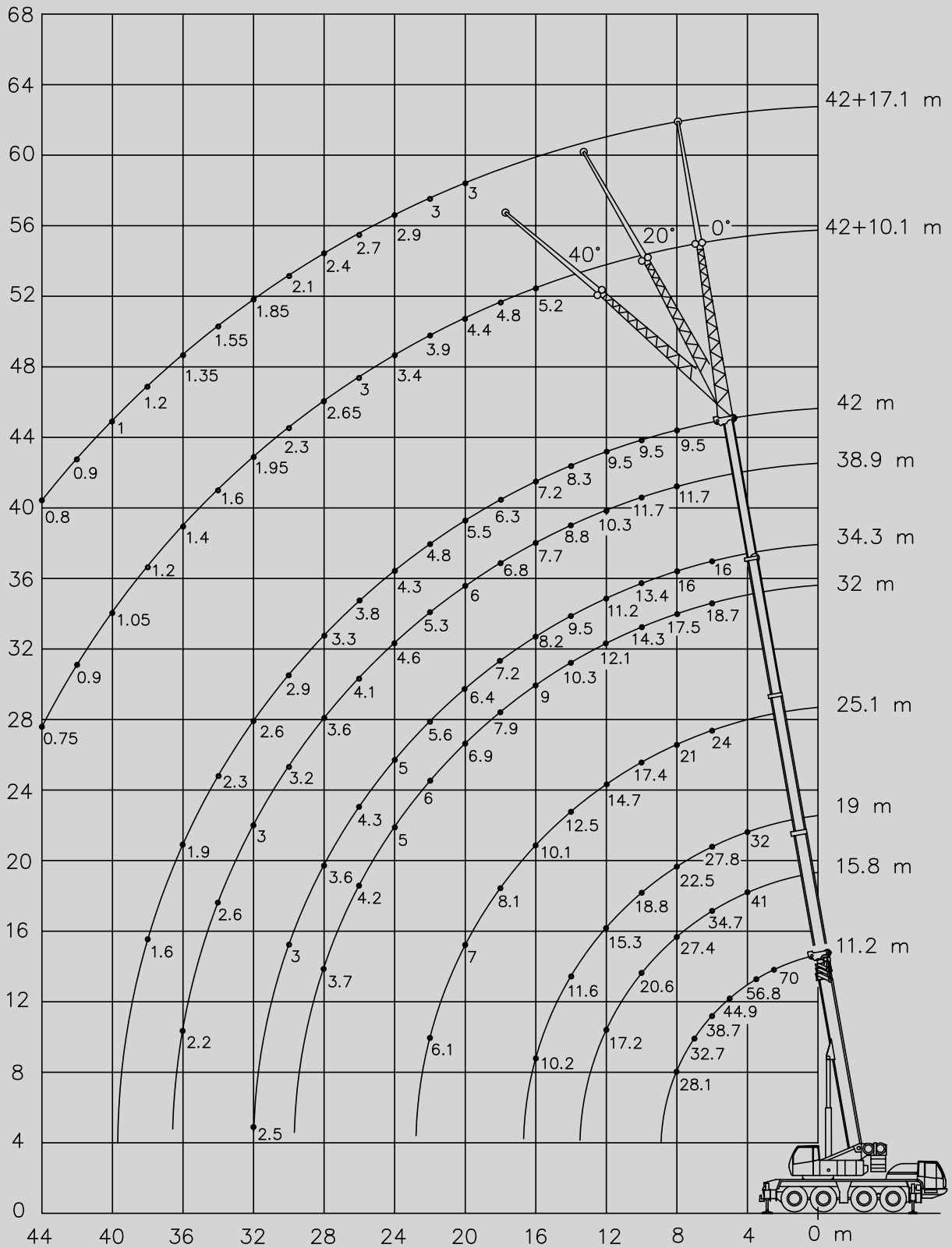



## Pesi - Weights - Poids

Carichi per asse - Macchina base in posizione di marcia.

Axle loads - Basic machine in travel order.

Charges par essieu - Machine en état de marche sur route.

asse axle essieu	1	2	3	4	peso totale total weight poids total
 t	12	12	12	12	48 (1)

asse axle essieu	1	2	3	4	peso totale total weight poids total
 t	13	13	13	13	52 (2)

1) con: zavorra da 7,6 t, argano ausiliario, bozzello da 50 t. e prolunga tralicciata

1) with: 7.6 t counterweight, auxiliary winch, hook block 50 t, lattice extension.

1) avec: contrepoids 7,6 t, treuil auxiliaire, moufle 50 t, et rallonge en treillis.

2) con: zavorra da 11,6 t, argano ausiliario, bozzello da 50 t. e prolunga tralicciata



2) with: 11.6 t counterweight, auxiliary winch, hook block 50 t, lattice extension.

2) avec: contrepoids 11,6 t, treuil auxiliaire, moufle 50 t, et rallonge en treillis.





## Velocità - Speed - Vitesse

Prestazioni del carro in km/h - Carrier performance km/h - Performances du porteur km/h.

Motore a 2000 g/min. - Engine at 2000 r.p.m. - Moteur à 2000 tours/min.

pneumatici tyres pneus	marcia gear vitesse	1	2	3	4	5	6	R	pendenza gradeability rampe
 16.00 R 25	 veloce fast vite	10.2	16.6	28.3	40.1	57.0	68.6	11.8	oltre 60%
	 lenta slow lente	5.9	9.6	16.4	23.3	33.0	39.8	6.8	





## Velocità della gru - Working speeds - Vitesses de travail

azionamenti drive entraînement	prestazioni performance performances	∅ fune / lunghezza fune ∅ rope / rope length ∅ câble / longueur câble	sforzo max sulla fune max pull of rope effort maxi câble
 1 argano principale main hoist treuil principal	0 - 103 m / min	18 mm / 220 m	50 KN
 2 argano ausiliario secondary hoist 2ème treuil	0 - 103 m / min	18 mm / 165 m	50 KN
 rotazione slewing rotation	0 - 1,7 g/min - r.p.m. - tours/min		
 sfilamento telescopico boom telescoping télescopage	da 11,2 a 42 m: from 11.2 to 42 m: de 11,2 à 42 m:	80 sec.	
 sollevamento braccio boom elevation élévation de flèche	da -2° a 80°: from -2° to 80°: de -2° à 80°:	45 sec.	

# Tabella di portata del braccio





## Lifting capacities on main boom

### Forces de levage sur flèche

 11,2 m - 42 m
 
 6,3 m
 
 60° (\*)
 
 16,1 t
 

m	11,2	15,8	18,1	19	25,1	25,1	32	34,3	38,9	42	m
	t	t	t	t	t(1)	t	t	t	t	t	
2,5	70,0										2,5
3	61,4										3
3,5	56,8										3,5
4	52,3	41,0	35,0	32,0							4
5	44,9	39,7	35,0	31,0	24,0	19,3					5
6	38,7	34,7	31,5	27,8	24,0	19,3	18,7	16,0			6
7	32,7	30,8	28,0	24,8	24,0	19,3	18,7	16,0	11,7		7
8	28,1	27,4	24,5	22,5	21,0	19,3	17,5	16,0	11,7	9,5	8
9		23,6	22,5	20,4	19,1	19,1	15,9	14,7	11,7	9,5	9
10		20,6	20,2	18,8	17,4	17,4	14,3	13,4	11,7	9,5	10
12		17,2	15,3	15,3	14,7	14,7	12,1	11,2	10,3	9,5	12
14			12,8	11,6	12,5	12,5	10,3	9,5	8,8	8,3	14
16				10,2	10,1	10,1	9,0	8,2	7,7	7,2	16
18					8,1	8,1	7,9	7,2	6,8	6,3	18
20					6,6	7,0	6,9	6,4	6,0	5,5	20
22					5,4	6,1	6,0	5,6	5,3	4,8	22
24							5,0	5,0	4,6	4,3	24
26							4,2	4,3	4,1	3,8	26
28							3,7	3,6	3,6	3,3	28
30								3,0	3,2	2,9	30
32								2,5	3,0	2,6	32
34									2,6	2,3	34
36									2,2	1,9	36
38										1,6	38
I	0	60-0	90-0	100-0	90	90-0	90-0	90-0	90-60	100	
II	0	0-20	0-30	0-34	30	30-60	60-90	70-100	90-100	100	
III	0	0-20	0-30	0-34	30	30-60	60-90	70-100	90-100	100	
IV	0	0-20	0-30	0-34	30	30-60	60-90	70-100	90-100	100	





(\*) sul posteriore - over rear - en arrière (1) spinato - pinned - verrouillé

 11,2 m - 42 m
 
 6,3 m
 
 360°
 
 16,1 t
 

m	11,2	15,8	18,1	19	25,1	25,1	32	34,3	38,9	42	m
	t	t	t	t	t(2)	t	t	t	t	t	
2,5	60,0										2,5
3	52,3										3
3,5	47,8										3,5
4	44,0	41,0	35,0	32,0							4
5	38,0	38,0	35,0	31,0	24,0	19,3					5
6	33,0	32,5	31,5	27,8	24,0	19,3	18,7	16,0			6
7	28,2	28,0	27,6	24,8	24,0	19,3	18,7	16,0	11,7		7
8	24,5	24,2	24,0	22,5	21,0	19,3	17,5	16,0	11,7	9,5	8
9		21,6	21,4	20,4	19,1	19,1	15,9	14,7	11,7	9,5	9
10		19,5	19,2	18,8	17,4	17,4	14,3	13,4	11,7	9,5	10
12		16,6	14,7	14,6	14,7	14,7	12,1	11,2	10,3	9,5	12
14			12,8	11,6	12,0	12,0	10,3	9,5	8,8	8,3	14
16				10,2	9,4	9,4	9,0	8,2	7,7	7,2	16
18					7,4	8,0	7,9	7,2	6,8	6,3	18
20					6,0	7,0	6,6	6,4	6,0	5,5	20
22					4,8	6,1	5,4	5,5	5,3	4,8	22
24							4,6	4,6	4,6	4,3	24
26							4,1	3,8	4,0	3,8	26
28							3,7	3,2	3,6	3,3	28
30								2,7	3,1	2,9	30
32								2,4	2,6	2,4	32
34									2,2	1,9	34
36									1,8	1,6	36
38										1,2	38
I	0	60-0	90-0	100-0	90	90-0	90-0	90-0	90-60	100	
II	0	0-20	0-30	0-34	30	30-60	60-90	70-100	90-100	100	
III	0	0-20	0-30	0-34	30	30-60	60-90	70-100	90-100	100	
IV	0	0-20	0-30	0-34	30	30-60	60-90	70-100	90-100	100	





(1) spinato - pinned - verrouillé

**Tabella di portata del braccio**  
**Lifting capacities on main boom**  
**Forces de levage sur flèche**

 11,2 m - 42 m
  6,3 m
  60° (\*)
  11,6 t
 

m	11,2	15,8	18,1	19	25,1	25,1	32	34,3	38,9	42	m
	t	t	t	t	t(1)	t	t	t	t	t	
2,5	70,0										2,5
3	60,7										3
3,5	55,8										3,5
4	51,6	41,0	35,0	32,0							4
5	44,0	39,7	35,0	31,0	24,0	19,3					5
6	36,0	34,7	31,5	27,8	24,0	19,3	18,7	16,0			6
7	30,8	30,3	28,0	24,8	24,0	19,3	18,7	16,0	11,7		7
8	26,0	25,5	24,5	22,5	21,0	19,3	17,5	16,0	11,7	9,5	8
9		22,0	21,7	20,4	19,1	19,1	15,9	14,7	11,7	9,5	9
10		19,3	18,1	18,1	17,4	17,4	14,3	13,4	11,7	9,5	10
12		14,9	14,7	13,2	14,2	14,2	12,1	11,2	10,3	9,5	12
14			11,7	11,6	10,8	10,8	10,3	9,5	8,8	8,3	14
16				9,4	8,4	8,4	9,0	8,2	7,7	7,2	16
18					6,7	8,0	7,3	7,2	6,8	6,3	18
20					5,3	6,7	5,9	6,0	6,0	5,5	20
22					4,3	5,6	5,1	5,0	5,2	4,8	22
24							4,6	4,1	4,4	4,3	24
26							4,1	3,4	3,9	3,6	26
28							3,6	3,0	3,2	3,0	28
30								2,7	2,7	2,5	30
32								2,4	2,3	2,0	32
34									1,9	1,6	34
36									1,5	1,3	36
38										1,0	38
I	0	60-0	90-0	100-0	90	90-0	90-0	90-0	90-60	100	
II	0	0-20	0-30	0-34	30	30-60	60-90	70-100	90-100	100	
III	0	0-20	0-30	0-34	30	30-60	60-90	70-100	90-100	100	
IV	0	0-20	0-30	0-34	30	30-60	60-90	70-100	90-100	100	





(\*) sul posteriore - over rear - en arrière (1) spinato - pinned - verrouillé

 11,2 m - 42 m
  6,3 m
  360°
  11,6 t
 

m	11,2	15,8	18,1	19	25,1	25,1	32	34,3	38,9	42	m
	t	t	t	t	t(1)	t	t	t	t	t	
2,5	60,0										2,5
3	50,6										3
3,5	46,4										3,5
4	42,6	41,0	35,0	32,0							4
5	36,7	36,3	35,0	31,0	24,0	19,3					5
6	32,1	31,7	31,4	27,8	24,0	19,3	18,7	16,0			6
7	28,0	27,5	27,2	24,8	24,0	19,3	18,7	16,0	11,7		7
8	23,7	23,2	23,0	22,5	21,0	19,3	17,5	16,0	11,7	9,5	8
9		20,0	19,7	19,6	19,1	19,1	15,9	14,7	11,7	9,5	9
10		19,1	17,1	17,0	17,4	17,4	14,3	13,4	11,7	9,5	10
12		14,0	14,3	13,2	13,3	13,3	12,1	11,2	10,3	9,5	12
14			10,9	11,0	9,9	10,2	10,3	9,5	8,8	8,3	14
16				8,6	7,6	9,0	8,2	8,2	7,7	7,2	16
18					5,9	7,3	6,5	6,6	6,8	6,3	18
20					4,6	6,0	5,7	5,3	5,6	5,5	20
22					3,6	5,0	5,1	4,3	4,8	4,6	22
24							4,4	3,7	4,0	3,7	24
26							3,7	3,3	3,3	3,0	26
28							3,1	3,0	2,7	2,5	28
30								2,7	2,2	2,0	30
32								2,2	1,8	1,6	32
34									1,4	1,2	34
36									1,1	0,9	36
38										0,6	38
I	0	60-0	90-0	100-0	90	90-0	90-0	90-0	90-60	100	
II	0	0-20	0-30	0-34	30	30-60	60-90	70-100	90-100	100	
III	0	0-20	0-30	0-34	30	30-60	60-90	70-100	90-100	100	
IV	0	0-20	0-30	0-34	30	30-60	60-90	70-100	90-100	100	

(1) spinato - pinned - verrouillé

**Tabella di portata del braccio**  
**Lifting capacities on main boom**  
**Forces de levage sur flèche**





 11,2 m - 42 m
  6,3 m
  60° (\*)
  7,6 t
 

m	11,2	15,8	18,1	19	25,1	25,1	32	34,3	38,9	42	m
	t	t	t	t	t(1)	t	t	t	t	t	
2,5	70,0										2,5
3	60,7										3
3,5	55,8										3,5
4	51,6	41,0	35,0	32,0							4
5	42,0	39,7	35,0	31,0	24,0	19,3					5
6	34,2	33,7	31,5	27,8	24,0	19,3	18,7	16,0			6
7	28,7	28,2	27,9	24,8	24,0	19,3	18,7	16,0	11,7		7
8	24,5	23,8	23,5	22,5	21,0	19,3	17,5	16,0	11,7	9,5	8
9		19,3	18,9	18,9	19,1	19,1	15,9	14,7	11,7	9,5	9
10		17,6	17,0	15,5	16,8	16,8	14,3	13,4	11,7	9,5	10
12		12,8	13,1	13,2	12,1	12,1	12,1	11,2	10,3	9,5	12
14			10,0	10,1	9,1	10,2	9,7	9,5	8,8	8,3	14
16				7,9	7,0	8,4	7,6	7,7	7,7	7,2	16
18					5,4	6,8	6,4	6,1	6,4	6,3	18
20					4,2	5,6	5,7	4,9	5,4	5,2	20
22					3,3	4,6	4,9	4,1	4,5	4,2	22
24							4,1	3,7	3,7	3,4	24
26							3,4	3,3	3,0	2,8	26
28							2,9	2,9	2,5	2,2	28
30								2,4	2,0	1,8	30
32								2,0	1,6	1,4	32
34									1,2	1,0	34
36									0,9	0,7	36

	I	II	III	IV	I	II	III	IV	I	II	III	IV	I	II	III	IV	I	II	III	IV	I	II	III	IV	I	II	III	IV							
0	0	60-0	90-0	100-0	90	90-0	90-0	90-0	90-0	90-60	100		0	0	20-0	30-0	0-34	30	30-60	60-90	70-100	90-100	100		0	0	20-0	30-0	0-34	30	30-60	60-90	70-100	90-100	100

(\*) sul posteriore - over rear - en arrière (1) spinato - pinned - verrouillé

 11,2 m - 42 m
  6,3 m
  360°
  7,6 t
 

m	11,2	15,8	18,1	19	25,1	25,1	32	34,3	38,9	42	m
	t	t	t	t	t(1)	t	t	t	t	t	
2,5	60,0										2,5
3	50,1										3
3,5	45,9										3,5
4	42,0	41,0	35,0	32,0							4
5	35,9	35,4	35,0	31,0	24,0	19,3					5
6	31,2	30,7	30,4	27,8	24,0	19,3	18,7	16,0			6
7	27,2	26,7	26,4	24,8	24,0	19,3	18,7	16,0	11,7		7
8	23,4	22,7	22,4	22,4	21,0	19,3	17,5	16,0	11,7	9,5	8
9		19,3	18,0	17,6	19,0	19,0	15,9	14,7	11,7	9,5	9
10		16,4	16,7	15,4	15,5	15,5	14,3	13,4	11,7	9,5	10
12		11,7	12,0	12,1	10,9	11,6	11,6	11,2	10,3	9,5	12
14			9,0	9,1	8,0	9,5	8,6	8,8	8,8	8,3	14
16				7,0	6,0	7,5	7,2	6,7	7,0	7,0	16
18					4,5	6,0	6,2	5,3	5,8	5,5	18
20					3,4	4,8	5,1	4,6	4,6	4,4	20
22					2,5	3,9	4,1	4,1	3,7	3,5	22
24							3,4	3,5	3,0	2,7	24
26							2,8	2,9	2,4	2,1	26
28							2,3	2,3	1,9	1,6	28
30								1,9	1,5	1,2	30
32								1,5	1,1	0,8	32
34									0,7	0,5	34

	I	II	III	IV	I	II	III	IV	I	II	III	IV	I	II	III	IV	I	II	III	IV	I	II	III	IV	I	II	III	IV							
0	0	60-0	90-0	100-0	90	90-0	90-0	90-0	90-0	90-60	100		0	0	20-0	30-0	0-34	30	30-60	60-90	70-100	90-100	100		0	0	20-0	30-0	0-34	30	30-60	60-90	70-100	90-100	100

(1) spinato - pinned - verrouillé





## Note relative alle tabelle di carico











- I carichi (CE) indicati rispettano per la stabilità le norme DIN 15019 parte 2 e ISO 4305. La struttura della gru è concepita secondo le norme DIN 15018 parte 3 e FEM 5004.
- La gru può lavorare con velocità del vento corrispondente a 5 e 7 Beaufort, in funzione della lunghezza del braccio.
- I pesi dei ganci e di tutti gli accessori per l'imbragatura fanno parte del carico e devono essere dedotti dai carichi indicati.
- I carichi indicati per il braccio principale sono intesi con prolunga tralicciata e falcone smontati.
- I carichi sono indicati in tonnellate.
- I raggi di lavoro sono calcolati a partire dall'asse di rotazione della torretta.
- Le portate indicate sono intese con stabilizzatori sfilati alla massima estensione.
- LA CAPACITÀ DI SOLLEVAMENTO DELLA TESTINA SUPPLEMENTARE È EQUIVALENTE ALLA PORTATA DEL BRACCIO PRINCIPALE CON UN LIMITE MASSIMO DI 5 t.

## Remarks referring to load charts

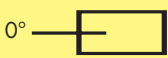
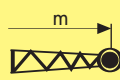
- The stated lifting capacities (CE) correspond to the tipping load in accordance with DIN 15019 part 2 and ISO 4305. The crane structural work is in accordance with DIN 15018 part 3 and FEM 5004.
- Crane operation is permissible up to wind corresponding to 5 and 7 Beaufort depending on boom length.
- Weight of hook blocks and of slings is part of the load and must be deducted from the capacity ratings.
- The lifting capacities given for the telescopic boom only apply if the folding jib and jib are dismantled.
- Lifting capacities are given in metric tons.
- Working radii are measured from the slewing centreline.
- The lifting capacities shown are with fully extended outriggers.
- THE RATED LIFTING CAPACITIES FOR THE ROOSTER SHEAVE ARE EQUIVALENT TO THE RATED LIFTING CAPACITIES OF THE MAIN BOOM UP TO A MAXIMUM OF 5 t.

## Remarques relatives aux tableaux des charges

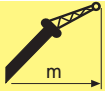
- Les charges (CE) indiquées respectent pour la stabilité les normes DIN 15019 partie 2 et ISO 4305. La structure de la grue est calculée selon les normes DIN 15018 partie 3 et FEM 5004.
- La grue peut travailler jusqu'à une vitesse du vent correspondante à 5 et 7 Beaufort en fonction de la longueur de flèche.
- Les poids du crochet-moufle et de tous les accessoires d'élingage font partie de la charge et sont à déduire des charges indiquées.
- Les forces indiquées pour la flèche télescopique s'entent fléchette dépliable et fléchette déposées.
- Les forces de levage sont données en tonnes.
- Les portées sont calculées à partir de l'axe de rotation de la plateforme.
- Les forces de levage s'entendent avec stabilisateurs complètement étendus.
- LES FORCES DE LEVAGE DE LA PETITE TÊTE SONT LES MÊMES QUE CELLES DE LA FLÈCHE PRINCIPALE AVEC UNE LIMITE MAXIMUM DE 5 t.

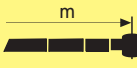
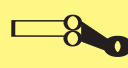
	braccio telescopico telescopic boom flèche télescopique		in rotazione 360° over 360° rotation en rotation 360°		lunghezza braccio % boom length % longueur flèche%
	prolunga ripiegabile lattice extension fléchette pliante		posteriore over rear en arrière		lunghezza falcone jib length longueur fléchette
	su stabilizzatori on outriggers stabilisateurs sortis		raggio di lavoro working radius rayon de travail		angolo braccio boom angle angle de flèche
	su pneumatici free on tyres sur pneus		raggio di lavoro working radius rayon de travail		angolo falcone jib angle angle de fléchette
	zavorre counterweights contrepoids		lunghezza braccio boom length longueur flèche		testina supplementare rooster head petite tête

**Tabella di portata della prolunga ripiegabile**  
**Lifting capacities of lattice extension**  
**Forces de levage à la fléchette pliante**

 34,3 - 38,9 - 42 m
  10,1 m
  6,3 m
  16,1 t
  360°
 **DIN ISO**

m	34,3 m			38,9 m			42 m			m
	0°	20°	40°	0°	20°	40°	0°	20°	40°	
	t	t	t	t	t	t	t	t	t	
8	8,50									8
10	8,00			6,50			5,20			10
12	7,50	4,85		6,50	4,90		5,20			12
14	7,00	4,65	2,80	6,50	4,75	2,80	5,20	4,85		14
16	6,30	4,45	2,70	5,80	4,50	2,75	5,20	4,65	2,80	16
18	5,60	4,25	2,65	5,20	4,35	2,65	4,80	4,50	2,70	18
20	5,00	4,00	2,55	4,80	4,25	2,60	4,40	4,25	2,65	20
22	4,50	3,85	2,50	4,20	4,00	2,55	3,90	3,90	2,55	22
24	4,00	3,65	2,40	3,70	3,75	2,50	3,40	3,50	2,50	24
26	3,50	3,40	2,35	3,30	3,40	2,40	3,00	3,10	2,45	26
28	3,00	3,20	2,30	2,80	3,00	2,35	2,65	2,70	2,40	28
30	2,70	2,80	2,25	2,45	2,70	2,30	2,30	2,30	2,35	30
32	2,40	2,60	2,25	2,05	2,30	2,20	1,95	2,05	2,20	32
34	2,10	2,30	2,25	1,85	2,10	2,00	1,60	1,80	1,90	34
36	1,80	1,90		1,70	1,85	1,80	1,40	1,60	1,60	36
38	1,40	1,50		1,50	1,60		1,20	1,40	1,40	38
40	1,10	1,20		1,20	1,30		1,05	1,20	1,15	40
42	0,90			0,90	1,00		0,90	1,00		42
44				0,70	0,70		0,70	0,70		44
I		90%			90%			100%		
II		70%			90%			100%		
III		70%			90%			100%		
IV		70%			90%			100%		

 34,3 - 38,9 - 42 m
  17,1 m
  6,3 m
  16,1 t
  360°
 **DIN ISO**

m	34,3 m			38,9 m			42 m			m
	0°	20°	40°	0°	20°	40°	0°	20°	40°	
	t	t	t	t	t	t	t	t	t	
10	3,50									10
12	3,50			3,20			3,00			12
14	3,50			3,20			3,00			14
16	3,40	2,45		3,20	2,45		3,00			16
18	3,30	2,30		3,20	2,35		3,00	2,45		18
20	3,15	2,20	1,30	3,20	2,25	1,30	3,00	2,30		20
22	2,95	2,10	1,25	3,10	2,20	1,25	3,00	2,20	1,30	22
24	2,75	2,00	1,20	2,95	2,05	1,25	2,90	2,10	1,25	24
26	2,55	1,90	1,20	2,75	2,00	1,20	2,70	2,00	1,20	26
28	2,40	1,80	1,15	2,55	1,90	1,20	2,40	1,95	1,20	28
30	2,25	1,70	1,10	2,35	1,80	1,15	2,10	1,90	1,15	30
32	2,05	1,65	1,10	2,10	1,70	1,10	1,85	1,80	1,10	32
34	1,85	1,60	1,05	1,90	1,65	1,10	1,55	1,70	1,10	34
36	1,65	1,55	1,05	1,65	1,60	1,05	1,35	1,55	1,10	36
38	1,45	1,50	1,00	1,50	1,50	1,05	1,20	1,45	1,05	38
40	1,30	1,45	1,00	1,35	1,40	1,00	1,00	1,25	1,05	40
42	1,15	1,35		1,20	1,35	1,00	0,90	1,05	1,00	42
44	0,95	1,10		0,95	1,15	0,95	0,80	0,95	0,95	44
46	0,75	0,85		0,75	0,90		0,65	0,85	0,90	46
I		90%			90%			100%		
II		70%			90%			100%		
III		70%			90%			100%		
IV		70%			90%			100%		

## Technical specifications of carrier

### CHASSIS

Manufactured by Marchetti, box-type structure, fabricated from highly torsion-resistant steel plate.

### OUTRIGGERS

4 telescopic hydraulically powered beams. Independent controls for each movement inside superstructure cab and on both sides of the carrier.

### ENGINE

Iveco mod. C10 ENT, Diesel turbo intercooler, Euro Mot 3A, water cooled, six cylinders in line.

Power: 265 kW (361 HP) at 2100 r.p.m.

Max torque: 1700 Nm at 1400 r.p.m.

### GEARBOX

Automatic ZF 6HP600, 6 speeds forward + 1 reverse, with retarder.

### REDUCTION GEAR

Two ratios, with lockable divider differential.

### AXLES

1st, 2nd, 3rd, 4th steering. 1st, 3rd, 4th driving.

Differential lock.

### SUSPENSIONS

Hydro-pneumatic with lock-up, adjustable for height and angle. Cylinder stroke 220 mm. Automatic self-levelling device.

### TYRES

Single on all axles, size 16.00 R 25

### STEERING

Double circuit ZF power-steering. Emergency pump on transmission. 4 steering axles. 4 steering modes.

### BRAKES

Service brake: pneumatic, 3 circuits, acting on all wheels. Emergency brake incorporated with service brake. Parking brake: spring-type with pneumatic control acting on 3rd and 4th axles. Hydraulic retarder mounted on the gearbox.

### CHASSIS CAB

Tilting two-man cab, sound-proof, full instrumentation, heating. Electrical pump to raise boom in case of engine failure

### ELECTRIC EQUIPMENT

24 Volts, 2 batteries 155 Ah

## Technical specifications of superstructure

### SUPERSTRUCTURE FRAME

Fabricated from highly resistant structural and torsional steel plate.

### HYDRAULIC EQUIPMENT

Four pumps feeding four independent and interconnected circuits, possibility of 3 simultaneous operations.

### WINCH

Grooved-drum with epicyclic reducer and automatic disc brake. Piston motor and check-valve.

### DERRICKING

Double acting cylinder with counterbalance and lockvalve.

### SLEWING

Epicyclic reducer with automatic disc brake, hydraulic motor with check and brake valve.

### SUPERSTRUCTURE CAB

Full view, adjustable seat, heating, complete with controls and instrumentation for both superstructure and chassis.

### BOOM

Telescopic, octagonal-shape section, made of extremely high resistant steel. One base element, first hydraulic independent section, 2nd, 3rd and 4th synchronized hydraulic sections. Partial telescoping under load.

### 11,6 t COUNTERWEIGHT

Compound blocks hydraulically mounted and controlled from cab.

### SAFETY DEVICES

Limit equipment on lifting and lowering motions. Safety valves. Pressure relief valves.

Safe load indicator.

## Optional equipment

- AUXILIARY WINCH
- LATTICE EXTENSION of 4,5 m, stowable alongside boom.
- INCLINABLE LATTICE EXTENSION from 10.1m to 17.1 m stowable alongside boom.
- ROOSTER SHEAVE for single line operation.
- ADDITIONAL 4,5 t COUNTERWEIGHT
- HOOK BLOCKS of various capacities.
- SPARE WHEEL
- Other special equipment supplied on request.

## Homologation

The All Terrain Crane MG 70.4 S complies with European regulation 98/37/CE

## Caractéristiques techniques du porteur

### CHASSIS

Construit par MARCHETTI, section à boîtier, en acier allié extrêmement résistant à la torsion.

### STABILISATEUR

Quatre poutres télescopiques commandées hydrauliquement. Commandes indépendantes pour chaque mouvement de la cabine en tourelle et sur les deux côtés du porteur.

### MOTEUR

IVECO type C10 ENT, Diesel-Turbo-intercooler, Euro Mot 3A, refroidi par eau, six cylindres in ligne.

Puissance maxi 265 kW (361 CV) à 2100 tours/m.

Couple maxi 1700 Nm à 1400 tours/m.

### BOITE DE VITESSE

Automatique, marque ZF 6HP600, 6 vitesses AV + 1 AR, avec retarder.

### TRANSFERT

A 2 rapports, avec répartiteur du différentiel blocable.

### ESSIEUX

1er, 2ème, 3ème, 4ème directeurs, 1er, 3ème et 4ème moteurs. Blocage des différentiels.

### SUSPENSIONS

Hydro-pneumatiques avec blocage, possibilité de régler l'hauteur de la machine, réglage transversal. Course des cylindres: 220 mm. Dispositif automatique de autonivellement.

### PNEUS

Simple sur tous les essieux, 16.00 R 25.

### DIRECTION

Direction hydraulique ZF à deux circuits. Pompe de secours actionnée par la transmission. 4 essieux directeurs, 4 possibilités de braquage.

### FREINS

Frein de service: pneumatique à 3 circuits agissant sur toutes les roues.

Frein de secours: incorporé dans le frein de service.

Frein de stationnement: à ressort par commande pneumatique, agissant sur le 3ème, 4ème essieu.

Frein ralentisseur hydraulique sur la boîte de vitesse (retarder).

### CABINE CONDUITE

Basculante, à 2 places, sièges amortis, insonorisée, instruments complets, chauffage. Pompe électrique pour relevage de la flèche en cas d'avarie au moteur.

### CIRCUIT ELECTRIQUE

24 Volts, 2 accumulateurs de 155 Ah.

## Caractéristiques techniques de la partie tournante.

### CHASSIS

En tôle d'acier à haute limite structurale et torsionale.

### EQUIPEMENT HYDRAULIQUE

4 pompes alimentent 4 circuits indépendants et interconnectés. Possibilité d'effectuer 3 manoeuvres simultanément.

### TREUIL

Tambour fileté avec réducteur épicycloïdal et frein automatique à disque, moteur à pistons et soupape de contrôle.

### RELEVAGE DE FLECHE

Un cylindre à double effet avec soupape de réglage et blocage.

### ROTATION

Réducteur épicycloïdal avec frein automatique à disques, moteur hydraulique avec soupape de contrôle.

### CABINE DE L'OPERATEUR

Grande visibilité, siège réglable, chauffage, complète avec commandes et instruments aussi pour la conduite du porteur.

### FLECHE

Télescopique à section octogonale fabriquée en tôle d'acier à très haute résistance. Un élément de base; 1er élément hydraulique indépendant, 2ème 3ème et 4ème éléments hydrauliques synchronisés. Télescopage sous charge partiel.

### CONTREPOIDS DE 11,6 t

Formé par plusieurs pièces componibles, déplaçables hydrauliquement.

### DISPOSITIFS DE SURETE

Dispositif fin-de-course pour la montée et la descente, soupapes de sûreté, soupapes de surpression. Limiteur électronique de moment.

## Equipement optionnel sur demande

- TREUIL AUXILIAIRE
- RALLONGE EN TREILLIS de 4.5 m répliable à la côté de la flèche.
- RALLONGE EN TREILLIS de 10.1 jusqu'à 17.1 m inclinable et répliable à la côté de la flèche.
- PETIT TETE RÉPLIABLE POUR TIR DIRECT
- CONTREPOIDS SUPPLÉMENTAIRE de 4.5 t
- CROCHETS de différentes capacités.
- ROUE DE SECOURS
- Equipements optionnels divers peuvent être fournis sur demande.

## Homologation

L'Autogrupe MG 70.4 S répond à la norme Européenne 98/37/CE.



MARCHETTI AUTOGRU S.p.A.

Via Caorsana, 49 - 29100 Piacenza - Italy

Tel. ++39 / 0523 / 573711

Fax ++39 / 0523 / 593253

WEB: <http://www.marchetti.it>

E-MAIL: [mark@marchetti.it](mailto:mark@marchetti.it)

Per il costante miglioramento del prodotto, dati e caratteristiche tecniche possono variare a nostro giudizio senza alcun obbligo di preavviso.

In accordance with our policy of constant improvement, we reserve the right to amend this specification at any time without notice.

Suivant notre politique d'amélioration, nous nous réservons le droit de modifier sans préavis certaines des caractéristiques indiquées dans cette notice.

Le informazioni riportate sono solo a titolo indicativo. La messa in servizio della macchina richiede l'osservanza del manuale d'Uso e delle tabelle di portata fornite con la macchina.

Data published in this brochure is to be intended as a guide; crane operation is subject to the observance of the Use & Maintenance manual and the Lifting Charts supplied with the machine.

Les renseignements ci-inclus, sont donnés à titre d'exemple; la mise en service de la machine est autorisée à condition que le manuel d'Utilisation et d'Entretien et les Tableaux de Charges fournies soient observés.