

2 Load carrying capacities

2.1 Load capacity tables WOLFF 6031.12 clear (8.3 t)

 8.3 t		Operating radius [m]	25	30	32.5	35	37.5	40	42.5	45	47.5	50	52.5	55	57.5	60	62.5	65	L-CC [t]	
JL [m]	65	2.75-21.4	7.0	5.6	5.1	4.7	4.3	3.9	3.6	3.4	3.1	2.9	2.7	2.6	2.4	2.3	2.1	2.0		
	62.5	2.75-23.3	7.7	6.2	5.6	5.2	4.7	4.4	4.0	3.8	3.5	3.3	3.1	2.9	2.7	2.5	2.4			
	60	2.75-24.9	8.3	6.7	6.1	5.6	5.1	4.8	4.4	4.1	3.8	3.6	3.4	3.2	3.0	2.8				
	57.5	2.75-25.7	8.3	7.0	6.3	5.8	5.3	4.9	4.6	4.3	4.0	3.7	3.5	3.3	3.1					
	55	2.75-26.3	8.3	7.2	6.5	6.0	5.5	5.1	4.7	4.4	4.1	3.9	3.6	3.4						
	52.5	2.75-26.8	8.3	7.3	6.7	6.1	5.6	5.2	4.8	4.5	4.2	3.9	3.7							
	50	2.75-27.7	8.3	7.6	6.9	6.3	5.8	5.4	5.0	4.7	4.4	4.1								
	47.5	2.75-28.3	8.3	7.8	7.1	6.5	6.0	5.6	5.2	4.8	4.5									
	45	2.75-28.7	8.3	7.9	7.2	6.6	6.1	5.7	5.3	4.9										
	42.5	2.75-29.4	8.3	8.1	7.4	6.8	6.3	5.8	5.4											
	40	2.75-29.8	8.3	8.2	7.5	6.9	6.4	5.9												
	37.5	2.75-29.9	8.3	8.3	7.6	6.9	6.4													
	35	2.75-30.2	8.3	8.3	7.6	7.0														
	32.5	2.75-30.1	8.3	8.3	7.6															
	30	2.75-30.0	8.3	8.3																
JL			Jib length																	
LCC			Load carrying capacity																	

The load carrying capacity is related to a hook range of 42.0 m. Hook ranges greater than that reduce the maximum load carrying capacity by the weight of the additional hoisting ropes (double-reeving mode = 2.5 kg per meter of the hook range).

2.2 Table of load carrying capacities (kg) in meter intervals, WOLFF 6031.12 clear (12.0 t, double reeving)

Operating radius [m]	Jib length [m]															
	30	32.5	35	37.5	40	42.5	45	47.5	50	52.5	55	57.5	60	62.5	65	
22	8300	8300	8300	8300	8300	8300	8300	8300	8300	8300	8300	8300	8300	8300	8060	
23	8300	8300	8300	8300	8300	8300	8300	8300	8300	8300	8300	8300	8300	8300	7660	
24	8300	8300	8300	8300	8300	8300	8300	8300	8300	8300	8300	8300	8300	8010	7300	
25	8300	8300	8300	8300	8300	8300	8300	8300	8300	8300	8300	8300	8300	8260	7650	6960
26	8300	8300	8300	8300	8300	8300	8300	8300	8300	8300	8300	8190	7900	7310	6650	
27	8300	8300	8300	8300	8300	8300	8300	8300	8300	8230	8070	7840	7570	7000	6360	
28	8300	8300	8300	8300	8300	8300	8300	8300	8190	7900	7740	7530	7260	6710	6100	
29	8300	8300	8300	8300	8300	8300	8210	8070	7870	7590	7430	7230	6970	6440	5850	
30	8300	8300	8300	8280	8230	8110	7900	7770	7570	7300	7150	6950	6700	6190	5620	
31		8020	8050	7970	7930	7810	7610	7480	7290	7030	6880	6690	6450	5960	5400	
32		7740	7760	7690	7650	7530	7340	7210	7030	6780	6630	6450	6210	5740	5200	
32.5		7600	7620	7550	7520	7400	7210	7080	6900	6650	6520	6330	6100	5630	5100	
33			7490	7420	7380	7270	7080	6960	6780	6540	6400	6220	5990	5530	5010	
34			7240	7170	7140	7030	6840	6720	6550	6310	6180	6000	5780	5330	4830	
35			7000	6940	6900	6790	6610	6500	6330	6100	5970	5800	5590	5150	4660	
36				6710	6680	6570	6400	6290	6120	5900	5780	5610	5400	4980	4500	
37				6500	6470	6370	6200	6090	5930	5710	5590	5430	5220	4810	4350	
37.5				6400	6370	6270	6100	5990	5830	5620	5500	5340	5140	4730	4270	
38					6270	6170	6010	5900	5740	5530	5410	5260	5060	4660	4200	
39					6080	5980	5820	5720	5570	5360	5250	5090	4900	4510	4070	
40					5900	5810	5650	5550	5400	5200	5090	4940	4750	4370	3940	
41						5640	5490	5390	5240	5050	4940	4790	4610	4240	3810	
42						5480	5330	5230	5090	4900	4790	4650	4470	4110	3700	
42.5						5400	5250	5160	5020	4830	4720	4580	4410	4050	3640	
43							5180	5090	4950	4760	4660	4520	4340	3990	3590	
44							5040	4950	4810	4630	4530	4390	4220	3870	3480	
45							4900	4810	4680	4500	4400	4270	4100	3760	3380	
46								4680	4550	4380	4280	4150	3990	3660	3280	
47								4560	4430	4260	4170	4040	3880	3550	3190	
47.5								4500	4370	4210	4110	3980	3830	3510	3140	
48									4320	4150	4060	3930	3780	3460	3100	
49									4210	4040	3950	3830	3680	3360	3010	
50									4100	3940	3850	3730	3580	3280	2930	
51										3840	3750	3640	3490	3190	2850	
52										3750	3660	3540	3400	3110	2780	
52.5										3700	3610	3500	3360	3070	2740	
53											3570	3460	3320	3030	2700	
54											3480	3370	3230	2950	2630	
55											3400	3290	3150	2880	2560	
56												3210	3080	2810	2500	
57												3140	3010	2740	2440	
57.5												3100	2970	2700	2400	
58													2930	2670	2370	
59													2870	2610	2320	
60													2800	2550	2260	
61														2490	2200	
62														2430	2150	
62.5														2400	2120	
63															2100	
64															2050	
65															2000	

2.3 Load capacity tables WOLFF 6031.12 clear (12 t)





 12 t		Operating radius [m]	20	25	30	32.5	35	37.5	40	42.5	45	47.5	50	52.5	55	57.5	60	62.5	65	L-CC [t]	
JL [m]	65	2.75- 15.3	8.9	6.9	5.5	5.0	4.6	4.2	3.8	3.5	3.3	3.0	2.8	2.6	2.5	2.3	2.2	2.0	1.9		
	62.5	2.75- 16.6	9.7	7.6	6.1	5.5	5.1	4.6	4.3	3.9	3.7	3.4	3.2	3.0	2.8	2.6	2.4	2.3			
	60	2.75- 17.7	10.5	8.2	6.6	6.0	5.5	5.0	4.7	4.3	4.0	3.7	3.5	3.3	3.1	2.9	2.7				
	57.5	2.75- 18.3	10.9	8.5	6.9	6.2	5.7	5.2	4.8	4.5	4.2	3.9	3.6	3.4	3.2	3.0					
	55	2.75- 18.8	11.2	8.7	7.1	6.4	5.9	5.4	5.0	4.6	4.3	4.0	3.8	3.5	3.3						
	52.5	2.75- 19.1	11.4	8.9	7.2	6.6	6.0	5.5	5.1	4.7	4.4	4.1	3.8	3.6							
	50	2.75- 19.7	11.8	9.2	7.5	6.8	6.2	5.7	5.3	4.9	4.6	4.3	4.0								
	47.5	2.75- 20.2	12.0	9.4	7.7	7.0	6.4	5.9	5.5	5.1	4.7	4.4									
	45	2.75- 20.5	12.0	9.6	7.8	7.1	6.5	6.0	5.6	5.2	4.8										
	42.5	2.75- 20.9	12.0	9.9	8.0	7.3	6.7	6.2	5.7	5.3											
	40	2.75- 21.2	12.0	10.0	8.1	7.4	6.8	6.3	5.8												
	37.5	2.75- 21.3	12.0	10.1	8.2	7.5	6.8	6.3													
	35	2.75- 21.5	12.0	10.1	8.3	7.5	6.9														
	32.5	2.75- 21.4	12.0	10.1	8.2	7.5															
	30	2.75- 21.4	12.0	10.1	8.2																
	JL			Jib length																	
LCC			Load carrying capacity																		

The load carrying capacity is related to a hook range of 42.0 m. Hook ranges greater than that reduce the maximum load carrying capacity by the weight of the additional hoisting ropes (double-reeving mode = 2.5 kg per meter of the hook range).

2.4 Table of load carrying capacities (kg) in meter intervals, WOLFF 6031.12 clear (12.0 t, quadruple reeving)

Operating radius [m]	Jib length [m]														
	30	32.5	35	37.5	40	42.5	45	47.5	50	52.5	55	57.5	60	62.5	65
15	12000	12000	12000	12000	12000	12000	12000	12000	12000	12000	12000	12000	12000	12000	12000
16	12000	12000	12000	12000	12000	12000	12000	12000	12000	12000	12000	12000	12000	12000	11390
17	12000	12000	12000	12000	12000	12000	12000	12000	12000	12000	12000	12000	12000	11670	10650
18	12000	12000	12000	12000	12000	12000	12000	12000	12000	12000	12000	12000	11800	10950	9990
19	12000	12000	12000	12000	12000	12000	12000	12000	12000	12000	11830	11510	11120	10310	9410
20	12000	12000	12000	12000	12000	12000	12000	12000	11800	11400	11180	10880	10500	9740	8880
21	12000	12000	12000	12000	12000	11950	11660	11470	11180	10800	10590	10300	9940	9220	8400
22	11620	11650	11690	11580	11530	11360	11070	10890	10620	10250	10050	9780	9440	8740	7960
23	11060	11090	11130	11030	10970	10810	10540	10370	10100	9760	9560	9300	8970	8310	7560
24	10550	10580	10610	10520	10470	10310	10050	9880	9630	9300	9110	8860	8550	7910	7200
25	10080	10110	10140	10050	10000	9850	9600	9440	9200	8880	8700	8460	8160	7550	6860
26	9650	9680	9700	9620	9570	9430	9180	9030	8800	8490	8320	8090	7800	7210	6550
27	9240	9270	9300	9220	9170	9030	8800	8650	8430	8130	7970	7740	7470	6900	6260
28	8870	8900	8930	8840	8800	8670	8440	8300	8090	7800	7640	7430	7160	6610	6000
29	8520	8550	8580	8500	8460	8330	8110	7970	7770	7490	7330	7130	6870	6340	5750
30	8200	8230	8250	8180	8130	8010	7800	7670	7470	7200	7050	6850	6600	6090	5520
31		7920	7950	7870	7830	7710	7510	7380	7190	6930	6780	6590	6350	5860	5300
32		7640	7660	7590	7550	7430	7240	7110	6930	6680	6530	6350	6110	5640	5100
32.5		7500	7520	7450	7420	7300	7110	6980	6800	6550	6420	6230	6000	5530	5000
33			7390	7320	7280	7170	6980	6860	6680	6440	6300	6120	5890	5430	4910
34			7140	7070	7040	6930	6740	6620	6450	6210	6080	5900	5680	5230	4730
35			6900	6840	6800	6690	6510	6400	6230	6000	5870	5700	5490	5050	4560
36				6610	6580	6470	6300	6190	6020	5800	5680	5510	5300	4880	4400
37				6400	6370	6270	6100	5990	5830	5610	5490	5330	5120	4710	4250
37.5				6300	6270	6170	6000	5890	5730	5520	5400	5240	5040	4630	4170
38					6170	6070	5910	5800	5640	5430	5310	5160	4960	4560	4100
39					5980	5880	5720	5620	5470	5260	5150	4990	4800	4410	3970
40					5800	5710	5550	5450	5300	5100	4990	4840	4650	4270	3840
41						5540	5390	5290	5140	4950	4840	4690	4510	4140	3710
42						5380	5230	5130	4990	4800	4690	4550	4370	4010	3600
42.5						5300	5150	5060	4920	4730	4620	4480	4310	3950	3540
43							5080	4990	4850	4660	4560	4420	4240	3890	3490
44							4940	4850	4710	4530	4430	4290	4120	3770	3380
45							4800	4710	4580	4400	4300	4170	4000	3660	3280
46								4580	4450	4280	4180	4050	3890	3560	3180
47								4460	4330	4160	4070	3940	3780	3450	3090
47.5								4400	4270	4110	4010	3880	3730	3410	3040
48									4220	4050	3960	3830	3680	3360	3000
49									4110	3940	3850	3730	3580	3260	2910
50									4000	3840	3750	3630	3480	3180	2830
51										3740	3650	3540	3390	3090	2750
52										3650	3560	3440	3300	3010	2680
52.5										3600	3510	3400	3260	2970	2640
53											3470	3360	3220	2930	2600
54											3380	3270	3130	2850	2530
55											3300	3190	3050	2780	2460
56												3110	2980	2710	2400
57												3040	2910	2640	2340
57.5												3000	2870	2600	2300
58													2830	2570	2270
59													2770	2510	2220
60													2700	2450	2160
61														2390	2100
62														2330	2050
62.5														2300	2020
63															2000
64															1950
65															1900

3 Tower combinations

	<p> DANGER</p> <p>Usage of incorrect tower combinations. The slewing tower crane may overturn.</p> <ol style="list-style-type: none">1) Use the specified tower combinations.2) If you need another tower combination that is not specified here, please contact WOLFFKRAN to get an approved alternative setup in writing.
	<p>NOTICE</p> <p>All tower combinations apply to free standing slewing tower cranes without climbing gear.</p>
	<p>NOTICE</p> <p>For tower combination with tower element TV 25 and UV 25 please contact WOLFFKRAN.</p>

3.1 Tower combinations on foundation

Jib length	30 m – 65 m			
Item				
1	4.5 m	UV 20.4	UV 20.4	TV 20.4
2	9.0 m	UV 20.4	UV 20.4	TV 20.4
3	13.5 m	UV 20.4	UV 20.4	TV 20.4
4	18.0 m	UV 20.4	UV 20.4	TV 20.4
5	22.5 m	UV 20.4	UV 20.4	TV 20.4
6	27.0 m	UV 20.4	UV 20.4	TV 20.4
7	31.5 m	UV 20.4	UV 20.4	TV 20.4
8	36.0 m	UV 20.4	UV 20.4	TV 20.4
9	40.5 m	UV 20.4	UV 20.4	TV 20.4
10	45.0 m	UV 20.4	UV 20.4	TV 20.4
11	49.5 m	UV 20.4	TVA 20.4	TV 20.4
12	54.0 m		TV 20.4	TV 20.4
13	58.5 m		TV 20.4	TV 20.4
14	63.0 m		TV 20.4	TV 20.4
15	67.5 m		TV 20.4	TV 20.4
Foundation		FUA 120 type C-120	FUA 140 type D-140	FUA 140 type D-140
Tower height [m]		49.5	67.5	67.5
Hook height double reeving [m]		51.0	69.0	69.0
Hook height quadruple reeving [m]		50.6	68.6	68.6

Jib length	30 m – 65 m			
Item				
1	4.5 m	UV 20.4		
2	9.0 m	UV 20.4		
3	13.5 m	UV 20.4		
4	18.0 m	UV 20.4		
5	22.5 m	UV 20.4		
6	27.0 m	UV 20.4		
7	31.5 m	UV 20.4		
8	36.0 m	UV 20.4		
9	40.5 m	UV 20.4		
10	45.0 m	UV 20.4		
11	49.5 m	TVA 20.4		
12	54.0 m	TV 20.4		
13	58.5 m	TV 20.4		
14	63.0 m	TV 20.4		
15	64.0 m	VR 2023		
16	68.5 m	TV 23		
17	73.0 m	TV 23		
Foundation		FUA 140 type D-140		
Tower height [m]		73.0		
Hook height double reeving [m]		74.5		
Hook height quadruple reeving [m]		74.1		

WOLFFKRAN

Jib length	30 m – 65 m			
Item				
1	4.5 m	UV 20.4		
2	9.0 m	UV 20.4		
3	13.5 m	UV 20.4		
4	18.0 m	UV 20.4		
5	22.5 m	UV 20.4		
6	27.0 m	UV 20.4		
7	31.5 m	UV 20.4		
8	36.0 m	UV 20.4		
9	40.5 m	UV 20.4		
10	45.0 m	TVA 20.4		
11	49.5 m	TV 20.4		
12	54.0 m	TV 20.4		
13	58.5 m	TV 20.4		
14	63.0 m	TV 20.4		
15	64.0 m	VR 2023		
16	68.5 m	TV 23		
17	73.0 m	HTA 23		
18	77.5 m	HT 23		
19	82.0 m	HT 23		
20	86.5 m	HT 23		
Foundation		FUA G 160		
Tower height [m]		86.5		
Hook height double reeving [m]		88.0		
Hook height quadruple reeving [m]		87.6		

Jib length	30 m – 65 m			
Item				
1	4.5 m	UV 20.4		
2	9.0 m	UV 20.4		
3	13.5 m	UV 20.4		
4	18.0 m	UV 20.4		
5	22.5 m	UV 20.4		
6	27.0 m	UV 20.4		
7	31.5 m	UV 20.4		
8	36.0 m	UV 20.4		
9	40.5 m	UV 20.4		
10	45.0 m	TVA 20.4		
11	49.5 m	TV 20.4		
12	54.0 m	TV 20.4		
13	58.5 m	TV 20.4		
14	59.5 m	VR 2023		
15	64.0 m	TV 23		
16	68.5 m	HTA 23		
17	73.0 m	HT 23		
18	77.5 m	HT 23		
19	78.7 m	VR 23/25-29		
20	83.2 m	UV 29		
21	87.7 m	UV 29		
22	92.2 m	UV 29		
23	102.2 m	BT 29		
Foundation		FUA BT 29		
Tower height [m]		102.2		
Hook height double reeving [m]		103.7		
Hook height quadruple reeving [m]		103.3		

3.2 Tower combinations on cross frame

Item							
1	4.5 m	UV 20	UV 20	UV 20	UV 20	UV 20	UV 20
2	9.0 m	UV 20	UV 20	UV 20	UV 20	UV 20	UV 20
3	13.5 m	UV 20	UV 20	UV 20	UV 20	UV 20	UV 20
4	18.0 m	UV 20	UV 20	UV 20	UV 20	UV 20	UV 20
5	22.5 m	UV 20	UV 20	UV 20	UV 20	UV 20	UV 20
6	27.0 m	UV 20	UV 20	UV 20	UV 20	UV 20	UV 20
7	31.5 m	UV 20	UV 20	UV 20	UV 20	UV 20	UV 20
8	36.0 m		UV 20	UV 20	UV 20	UV 20	UV 20
9	40.5 m		UV 20	UV 20	UV 20	UV 20	UV 20
10	45.0 m		UV 20	UV 20	UV 20	TVA 20	TVA 20
11	49.5 m		TVA 20	TVA 20	TVA 20	TV 20	TV 20
12	54.0 m		TV 20	TV 20	TV 20	TV 20	TV 20
13	58.5 m		TV 20	TV 20	TV 20	TV 20	TV 20
14	63.0 m				TV 20	TVÜ 20	TVÜ 20
15	67.5 m				TVÜ 20	TV 25	TV 25
16	72.0 m					UVA 25	UVA 25
17	76.5 m					VR 2529	VR 2529
18	81.0 m					UV 29	UV 29
19	82.2 m					UV 29	UV 29
20	86.7 m					UV 29	UV 29
21	91.2 m					BT 29	BT 29
Substructure	KRV 7-32/ 46	KR 10-46	KR 10-46/ 60	KR 1000-8	KR 16-80	KR 16- 80/ 100	
[m x m]	4.6 x 4.6	4.6 x 4.6	6.0 x 6.0	8 x 8	8 x 8	10 x 10	
Substructure height [m]	0.9	1.2	1.2	1.2	1.8	1.8	
Tower height [m]	32.4	59.7	59.7	68.7	98.5	98.5	
Hook height above ground [m]	33.5	60.8	60.8	69.8	99.6	99.6	





3.3 Tower combinations on cross frame element



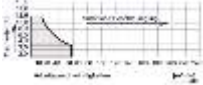
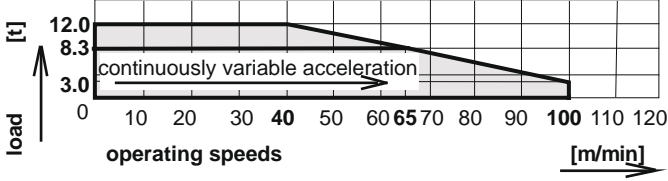

Item						
1	4.5 m	UV 20	UV 20	UV 20	UV 20	UV 20
2	9.0 m	UV 20	UV 20	UV 20	UV 20	UV 20
3	13.5 m	UV 20	UV 20	UV 20	UV 20	UV 20
4	18.0 m	UV 20	UV 20	UV 20	UV 20	UV 20
5	22.5 m	UV 20	UV 20	UV 20	UV 20	UV 20
6	27.0 m	UV 20	UV 20	UV 20	UV 20	UV 20
7	31.5 m	UV 20	UV 20	UV 20	UV 20	UV 20
8	36.0 m		UV 20	UV 20	UV 20	UV 20
9	40.5 m			UV 20	UV 20	UV 20
10	45.0 m			UV 20	UV 20	UV 20
11	49.5 m			TVA 20	TVA 20	TVA 20
12	54.0 m				TV 20	TV 20
13	58.5 m					TV 20
14	63.0 m					TVÜ 20
15	67.5 m					UVA 25
Substructure		KRE 260.1	KRE 260.1	KRE 260.2	KRE 260.2	KRE 480
[m x m]		5 x 6.79	6 x 6	5 x 6.79	6 x 6	8 x 8
Substructure height [m]		4.0	4.0	4.0	4.0	4.0
Tower height [m]		35.5	40.0	53.5	58.0	71.5
Hook height above ground [m]		36.6	41.1	54.6	59.1	72.6

3.4 Tower combinations on bogie truck



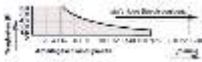

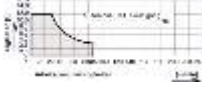
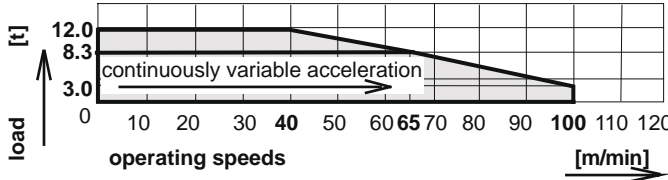

Item								
1	4.5 m	UV 20	UV 20	UV 20	UV 20	UV 20	UV 20	UV 20
2	9.0 m	UV 20	UV 20	UV 20	UV 20	UV 20	UV 20	UV 20
3	13.5 m	UV 20	UV 20	UV 20	UV 20	UV 20	UV 20	UV 20
4	18.0 m	UV 20	UV 20	UV 20	UV 20	UV 20	UV 20	UV 20
5	22.5 m	UV 20	UV 20	UV 20	UV 20	UV 20	UV 20	UV 20
6	27.0 m	UV 20	UV 20	UV 20	UV 20	UV 20	UV 20	UV 20
7	31.5 m		UV 20	UV 20	UV 20	UV 20	UV 20	UV 20
8	36.0 m			TVA 20	UV 20	UV 20	UV 20	UV 20
9	40.5 m				TVA 20	UV 20	UV 20	UV 20
10	45.0 m					UV 20	UV 20	UV 20
11	49.5 m					TVA 20	TVA 20	TVA 20
12	54.0 m						TV 20	TV 20
13	58.5 m							TV 20
14	63.0 m							TVÜ 20
15	67.5 m							UVA 25
	Substructure	UW 260.1	UW 260.1	UW 260.2	UW 260.2	UW 260.3	UW 260.3	UW 480
	[m x m]	5 x 6.79	6 x 6	5 x 6.79	6 x 6	5 x 6.79	6 x 6	8 x 8
	Substructure height [m]	4.5	4.5	4.5	4.5	4.5	4.5	5.0
	Tower height [m]	31.5	36.0	40.5	45.0	54.0	58.5	72.5
	Hook height above ground [m]	32.6	37.1	41.6	46.1	55.1	59.6	73.6

4 Operating speeds

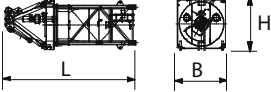
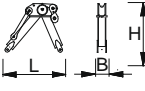
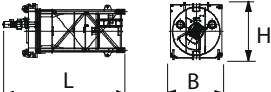
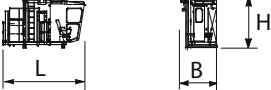
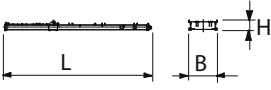
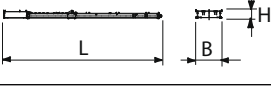

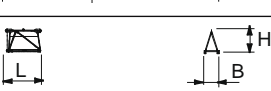
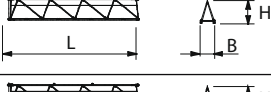
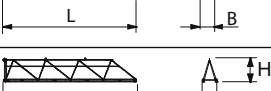

Drive unit [type]	Operating speed Carrying load		Hook travel distance max. [m]	Power [kW]	Total connected wattage [kVA]
Hw845FU	Lifting		190	45	67.0 Total connected load at coincidence factor of 0.7
	Lifting		95		
					
KW	Crab movement			7.5	
					
SG	Slewing			2x6.0	
					

Drive unit [type]	Operating speed Carrying load		Hook travel distance max. [m]	Power [kW]	Total connected wattage [kVA]
Hw875FU	Lifting		460	75	95.0 Total connected load at coincidence factor of 0.7
					
	Lifting		230		
					
KW	Crab movement			7.5	
					
SG	Slewing			2x6.0	
					

5 Package list 6031.12

Quantity	Description	Package	L [m]	W [m]	H [m]	Weight [kg]	Volume [m ³]		
1	Tower head section, complete with slewing frame, ball slew bearing, slewing gear and slip ring system		with UV 20 / TV 20 lower part of tower head section					9370	38.97
			6.67	2.30	2.54				
	Tower head section upper part with stay parts		2.33	0.58	2.81	1300	3.80		
	Tower head section lower part with slewing frame, ball slew bearing, slewing gear and slip ring system		5.77	2.30	2.54	8070	33.71		
1	Driver's cab with driver's cab suspension		4.46	1.96	2.55	2390	22.29		
1	Counter jib with stay parts and standard railings		14.04	2.30	0.80	6840	25.84		
	Counter jib without ballast carrier and without loose items		11.87	2.30	0.70	5280	19.11		
1	Hoist winch platform Hw875FU (incl. 200 m hoisting rope)		2.17	1.88	1.18	2500	4.82		
1	Jib section 1 with traverse gear		10.34	1.20	2.38	3265	29.53		
1	Jib section 2		10.32	1.20	2.36	2150	29.23		
1	Jib section 3		10.29	1.20	2.34	1600	28.90		
1	Jib section 4		5.27	1.20	1.74	775	11.0		
1	Jib section 5		2.77	1.20	1.74	470	5.78		
1	Jib section 6		10.25	1.20	1.72	1365	21.16		
1	Jib section 7		10.07	1.20	1.70	1045	20.75		
1	Jib section 8		10.17	1.20	1.70	800	20.75		

WOLFFKRAN

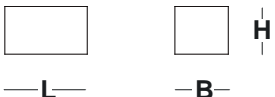
Quantity	Description	Package	L [m]	W [m]	H [m]	Weight [kg]	Volume [m ³]
1	Rope swivel cross-beam		0.99	1.09	0.45	126	0.49
1	Trolley LK 8/ 12		1.87	1.38	1.03	355	2.66
1	Maintenance cage		0.75	0.58	1.69	55	0.74
1	Snatch block U 8/ 16 AU		1.02	0.27	1.84	550	0.51
1	Standard railings		2.60	1.10	0.65	300	1.86
1	Box (small parts)		0.63	0.50	0.38	100	1.12

6 Assembly weights

6.1 Counterweight blocks



NOTICE

The described diagrams of the counterweights and central ballast blocks only show sketches. Have them issue the reinforcement charts by experts.

6.1.1 Counterweight block, 2.7 t

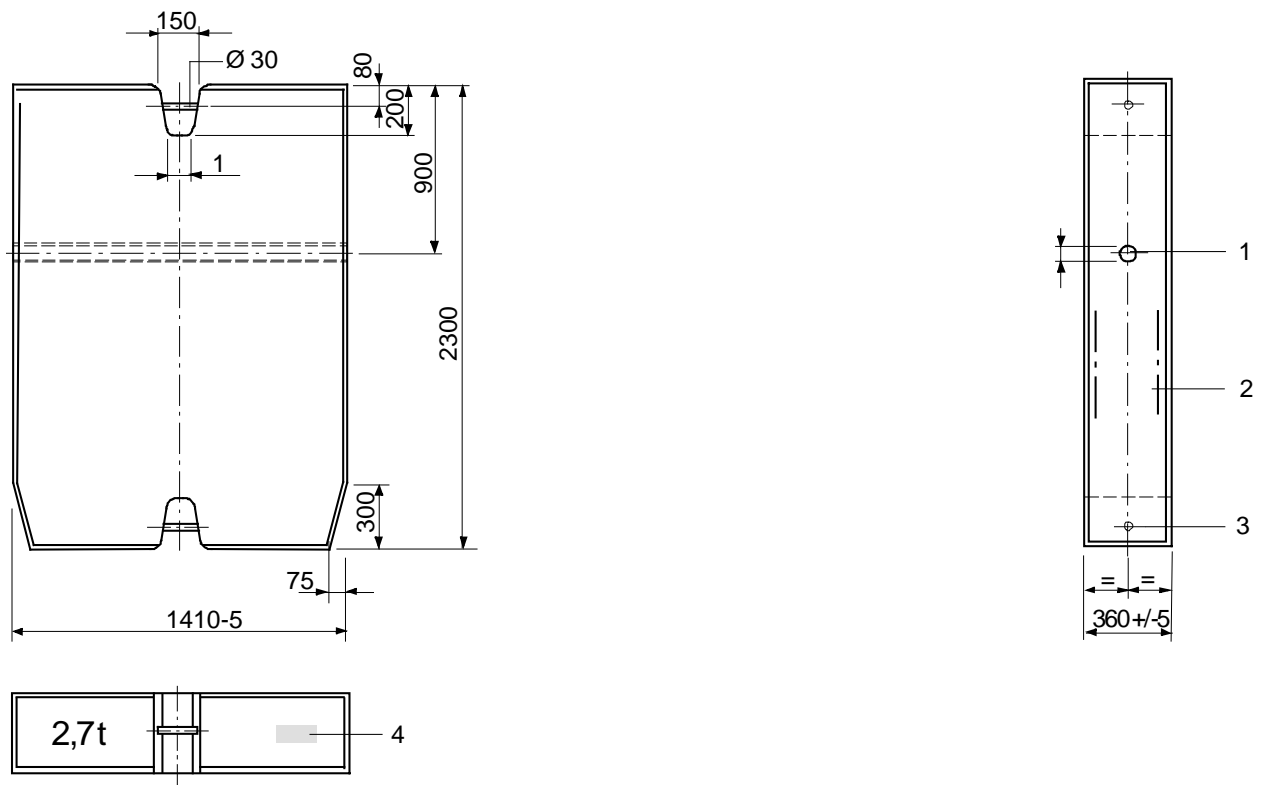

Data counterweight block 2.7 t

Item	Data
Material	Concrete, min. C 20/25
Max. permitted weight tolerance	+/- 3 %
Order number	962-2-005966
1	Connection for stub shaft (\varnothing 40/ 78 x 215 962-4-006490)
2	Structural steel reinforcement
3	Suspension
4	Component identifier

6.1.2 Counterweight block, 3.7 t

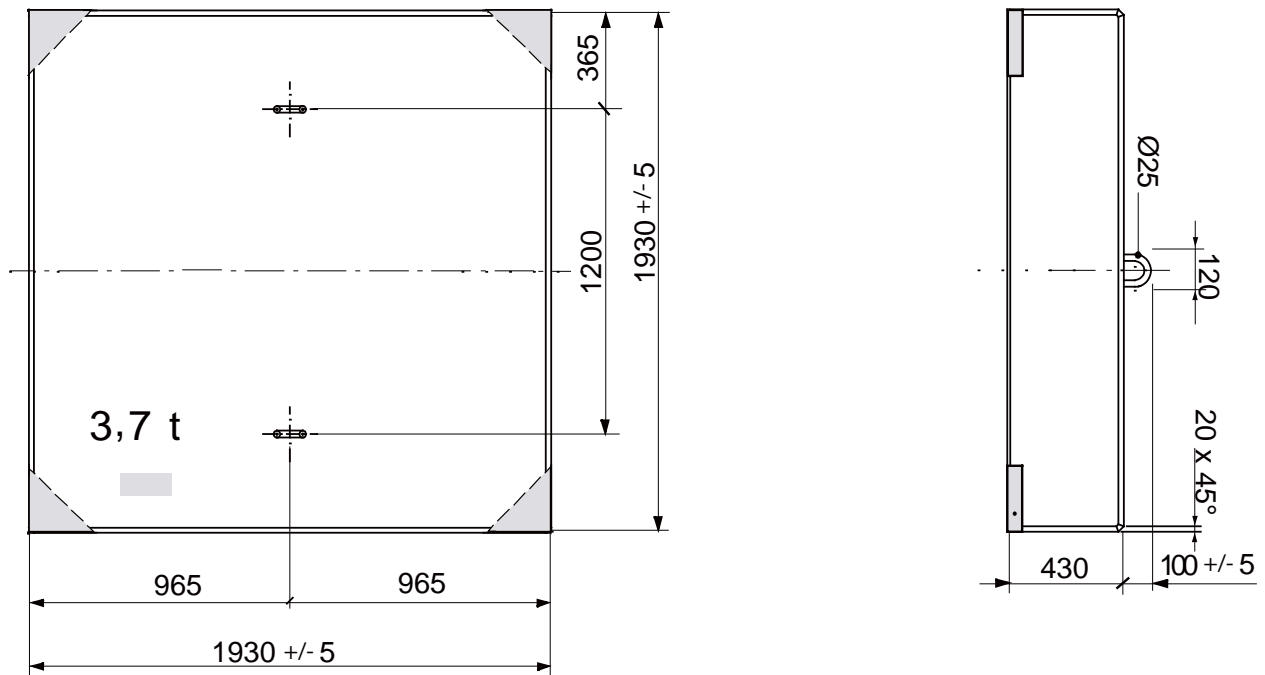

Data counterweight block 3.7 t

Item	Data
Material	Concrete, min. C 20/25
Max. permitted weight tolerance	+/- 3 %
Order number	962-2-029759
1	Corner guard
2	Suspension
3	Component identifier

6.2 Total weight jib assembly

Trolley jib, complete: Trolley, trolley ropes, snatch block, standard railings and rope swivel crossbeam

Jib length (m)	Weight (kg)	
	WOLFF 6031.8clear	WOLFF 6031.12clear
65	11800	12100
62.5	11500	11800
60	11000	11300
57.5	10900	11200
55	11000	11300
52.5	10700	11000
50	10200	10500
47.5	10100	10400
45	10000	10300
42.5	9700	10000
40	9200	9500
37.5	9100	9400
35	8600	8900
32.5	8300	8600
30	7800	8100

6.3 Assembly weight slewing gear

Module	Crane parts	Weight [kg]	
Tower head section complete with brace plates and standard railings			9370
	▪ Tower head section upper part including brace plates	1300	
	▪ Tower head section lower part including slewing frame, ball race bearing, slewing gears, standard railings and slip ring system	8070	
Operator cabinet platform, complete			2390
	▪ Driver's cab including control cabinet, resistor and driver's cab suspension		
Counter jib with Hw845FU, complete			12575
	▪ Counter jib with brace plates, standard railings and ballast frame	6840	
	▪ Hoist winch platform Hw845FU	2035	
	▪ Concrete counterweight block 3.7 t (below hoist winch platform)	3700	
Counter jib with Hw875FU, complete			12915
	▪ Counter jib with brace plates, standard railings and ballast frame	6840	
	▪ Hoist winch platform Hw875FU	2375	
	▪ Concrete counterweight block 3.7 t (below hoist winch platform)	3700	

6.4 Assembly weight cross frame

Module	Crane parts	Weight [kg]	
Cross frame KR 6-40 (without accessories)			
(4.0 m x 4.0 m)	▪ 4 bolted spigots AZ 93.4	200	3 450
	▪ 4 bolted spigots AZ 93.4 E 15	240	
Cross frame KR 7- 32 (without accessories)			
(3.2 m x 3.2 m)	▪ 4 bolted spigots AZ 85 E 20.5	210	3 350
	▪ 4 bolted spigots AZ 93.4 E 15	240	
	▪ 4 bolted spigots AZ 120 M	292	
Cross frame KR 7 - 32 (without accessories)			
(3.2 m x 3.2 m)	▪ 4 bolted spigots AZ 85 E 20.5	210	3 680
	▪ 4 bolted spigots AZ 93.4 E 15	240	
	▪ 4 bolted spigots AZ 120 M	292	
Cross frame KR 7 - 32/46 (without accessories)			
(4.6 m x 4.6 m)	▪ 4 bolted spigots AZ 85 E 20.5	210	5 090
	▪ 4 bolted spigots AZ 93.4 E 15	240	
	▪ 4 bolted spigots AZ 120 M	292	
Cross frame KR 8- 46 (without accessories)			
(4.6 m x 4.6 m)	▪ 4 bolted spigots AZ 85 E 20.5	210	5 250
	▪ 4 bolted spigots AZ 93.4 E 15	240	
	▪ 4 bolted spigots AZ 120 M	292	
Cross frame KR 10- 46 (without accessories)			
(4.6 m x 4.6 m)	▪ 4 bolted spigots AZR 120 E 15.5	552	7 020
	▪ 4 bolted spigots AZ 140 M	698	
Cross frame KR 16 - 46/ 60 (without accessories)			
(6.0 m x 6.0 m)	▪ 4 bolted spigots AZR 120 E 15.5	552	8 875
	▪ 4 bolted spigots AZ 140 M	698	
Cross frame KR HEB 700 - 4 (without accessories)			
(4.0 m x 4.0 m)	▪ 4 bolted spigots AZ 93.4	240	4 450
Cross frame KR HEB 700 - 5 (without accessories)			
(5.0 m x 5.0 m)	▪ 4 bolted spigots AZ 93.4	240	5 410
Cross frame KR HEB 800 - 5 (without accessories)			
(5.0 m x 5.0 m)	▪ 4 bolted spigots AZ 120 M	292	5 860
Cross frame KR HEB 800 - 6 (without accessories)			
(6.0 m x 6.0 m)	▪ 4 bolted spigots AZ 120 M	292	6 600
Supporting frame SR 150 (without accessories)			
(4.0 m x 4.0 m)	▪ 4 bolted spigots AZ 85 E 20.5	210	5 460
	▪ 4 bolted spigots AZ 93.4 E 15	240	
	▪ 4 bolted spigots AZ 120 M	292	
Cross frame KR 1000- 8 (without accessories)			
(8 m x 8 m)	▪ 4 bolted spigots AZ 140 E	684	14 630

Module	Crane parts	Weight [kg]	
	▪ 4 bolted spigots AZ 156 M	748	
Cross frame KR 16- 80 (without accessories)			21 450
(8 m x 8 m)	▪ 4 bolted spigots AZ 140 E KR 16-80	620	
	▪ 4 bolted spigots AZ 156 M KR 16-80	680	
	▪ 4 bolted spigots AZ 156S M KR 16-80	675	
Cross frame KR 16 - 80 / 100 (without accessories)			25 400
(10 m x 10 m)	▪ 4 bolted spigots AZ 140 E KR 16-80	620	
	▪ 4 bolted spigots AZ 156 M KR 16-80	680	
	▪ 4 bolted spigots AZ 156S M KR 16-80	675	

6.5 Hook height above ground required for mobile cranes

For information about the height of the WOLFF slewing tower crane, refer to Tower combinations [6].

NOTICE! During assembly, allowances must be made for level differences (mobile crane to base of the slewing tower crane).

Hook height above ground required for mobile cranes (X) = height of the WOLFF slewing tower crane (A) + clearance of 12 (B).

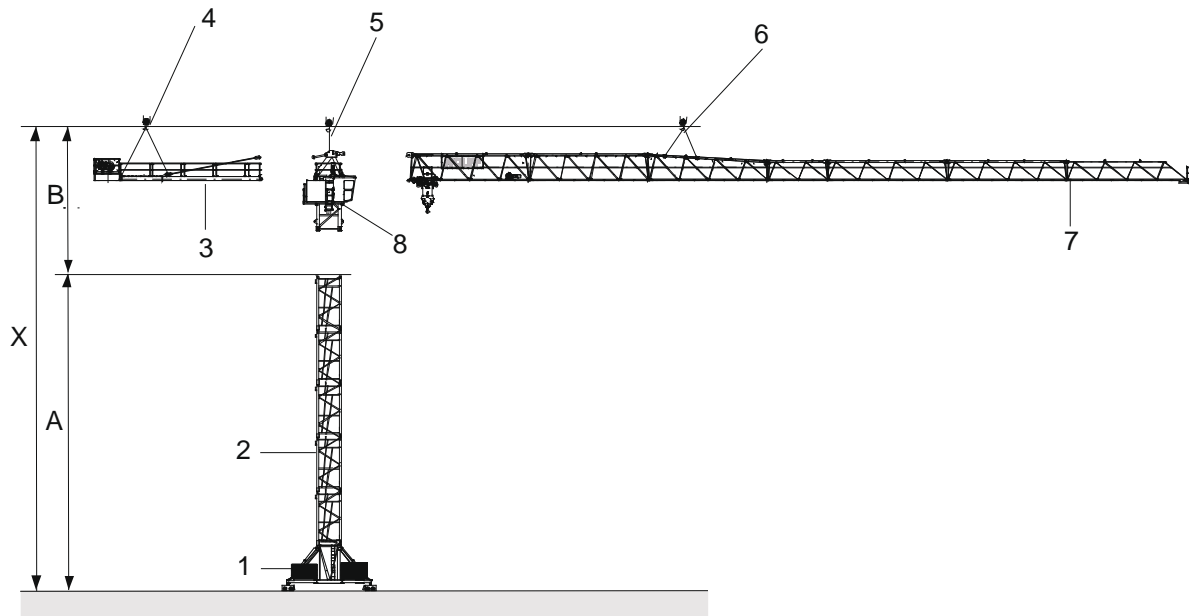

Exemplary illustration

[A]	Height of the WOLFF slewing tower crane	[B]	Clearance 12 m
[X]	Hook height above ground required for the mobile crane		
1	Undercarriage	5	Single-point lifting tackle (2 m with shackle)
2	Tower element	6	Four-point lifting tackle (4 m with shackle)
3	Counter jib, complete	7	Jib, complete
4	Four-point lifting tackle (with shackle)	8	Tower head section, complete

See also:

- Tower combinations [6]

7 Assembly diagrams

7.1 Jib attachment diagram

	NOTICE
	For jib assembly, use a Four-point lifting tackle (4 m with shackle).

	NOTICE
	To install the hook block within two sling ropes to DIN 3088 (Ø 8 mm x 1 m with shackle), attach it to the trolley, reeve in the mounting rope (Perlon, Ø 14 mm x 12 m) and secure it on the trolley.

Length of jib elements

Item	in [m]
Slewing trolley jib element 1, 2, 3, 6, 7, 8	10.0
Trolley jib element 4	5.0
Trolley jib element 5	2.5
Rope swivel crossbeam	0.51

7.1.1 Slewing Trolley Jib Lifting Diagram 65 m to 55 m (6031.12 clear)

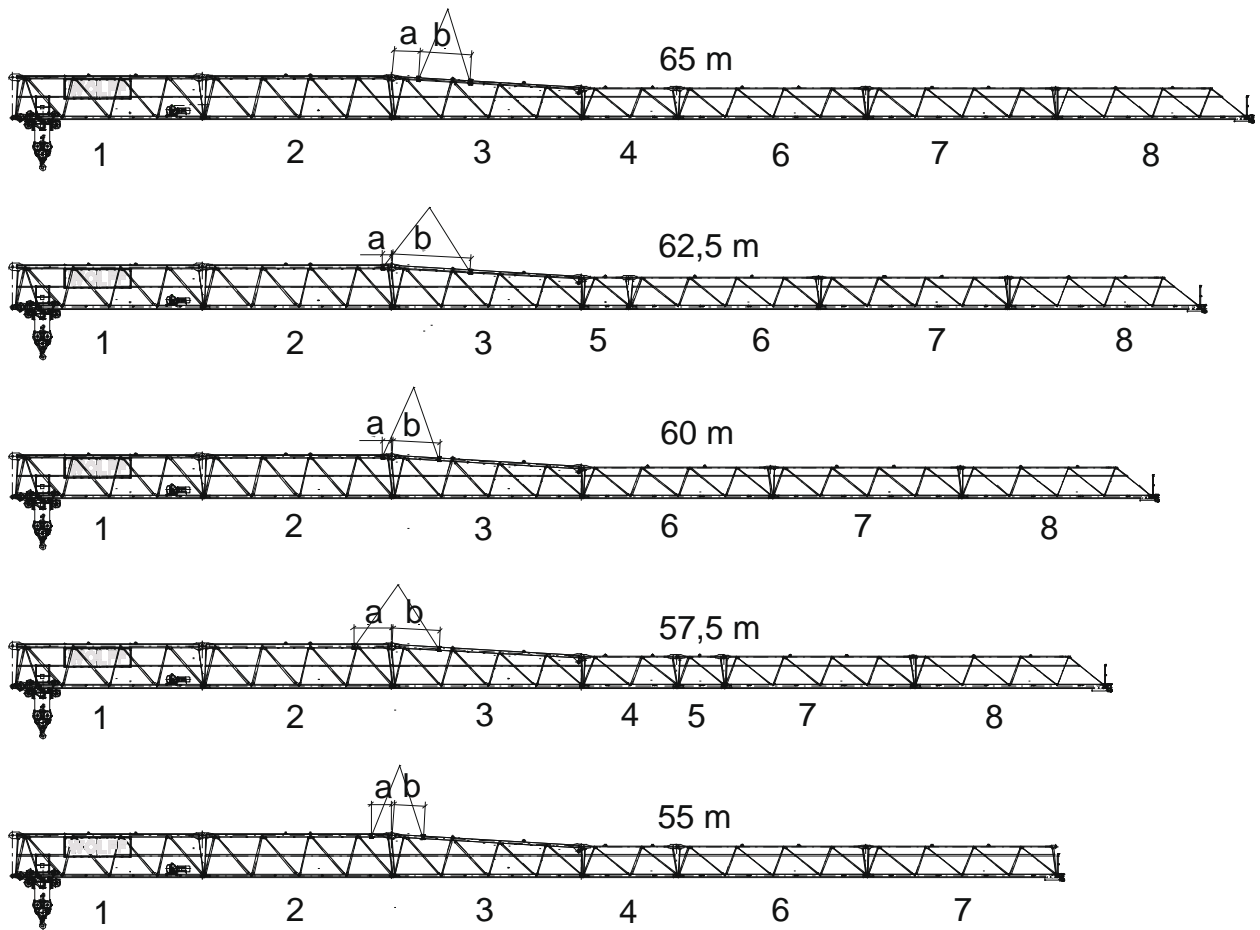

a	Dimension a
b	Dimension b

Data	Jib length [m]				
	65	65.5	60	57.5	55
a [mm]	1404	495	495	2016	1085
b [mm]	2734	4138	2469	2469	1634
Weight [kg] 6031.12 clear	12100	11800	11300	11200	11300

7.1.2 Slewing Trolley Jib Lifting Diagram 52.5 m to 42.5 m (6031.12 clear)

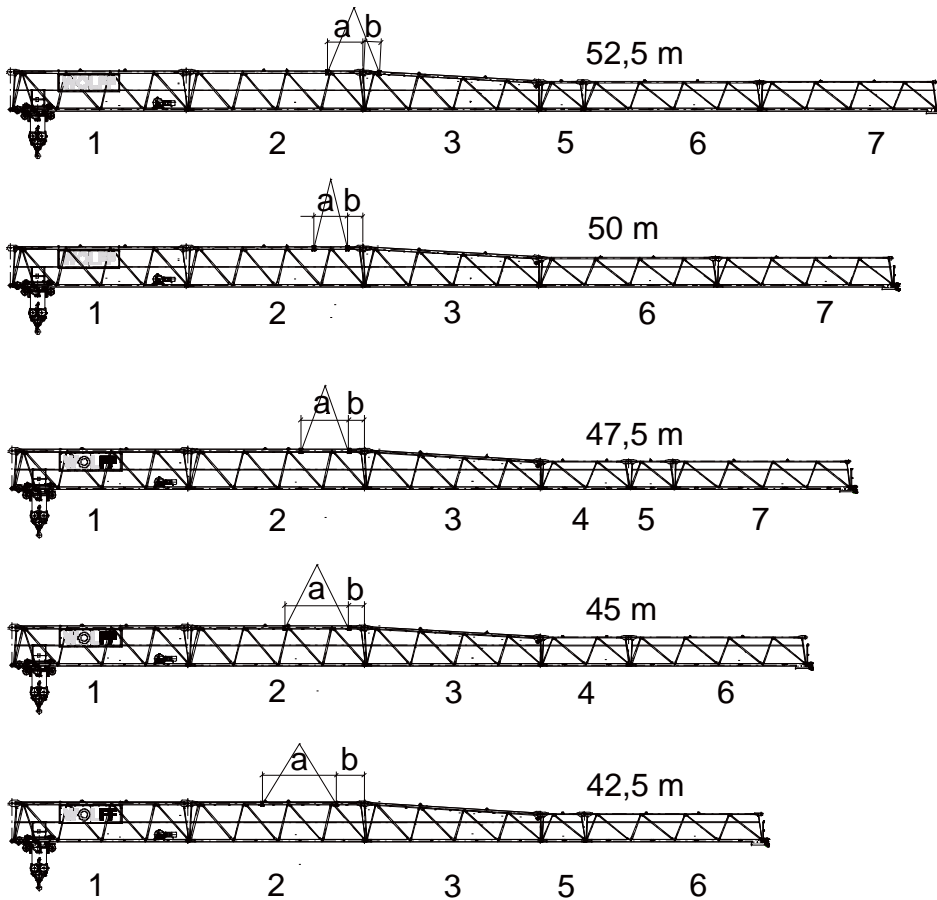

a	Dimension a
b	Dimension b

Data	Jib length [m]				
	52.5	50	47.5	45	42.5
a [mm]	2016	897	2730	3662	4209
b [mm]	934	855	855	855	1564
Weight [kg] 6031.12 clear	11000	10500	10400	10300	10000

7.1.3 Slewing Trolley Jib Lifting Diagram 40 m to 30 m (6031.12 clear)

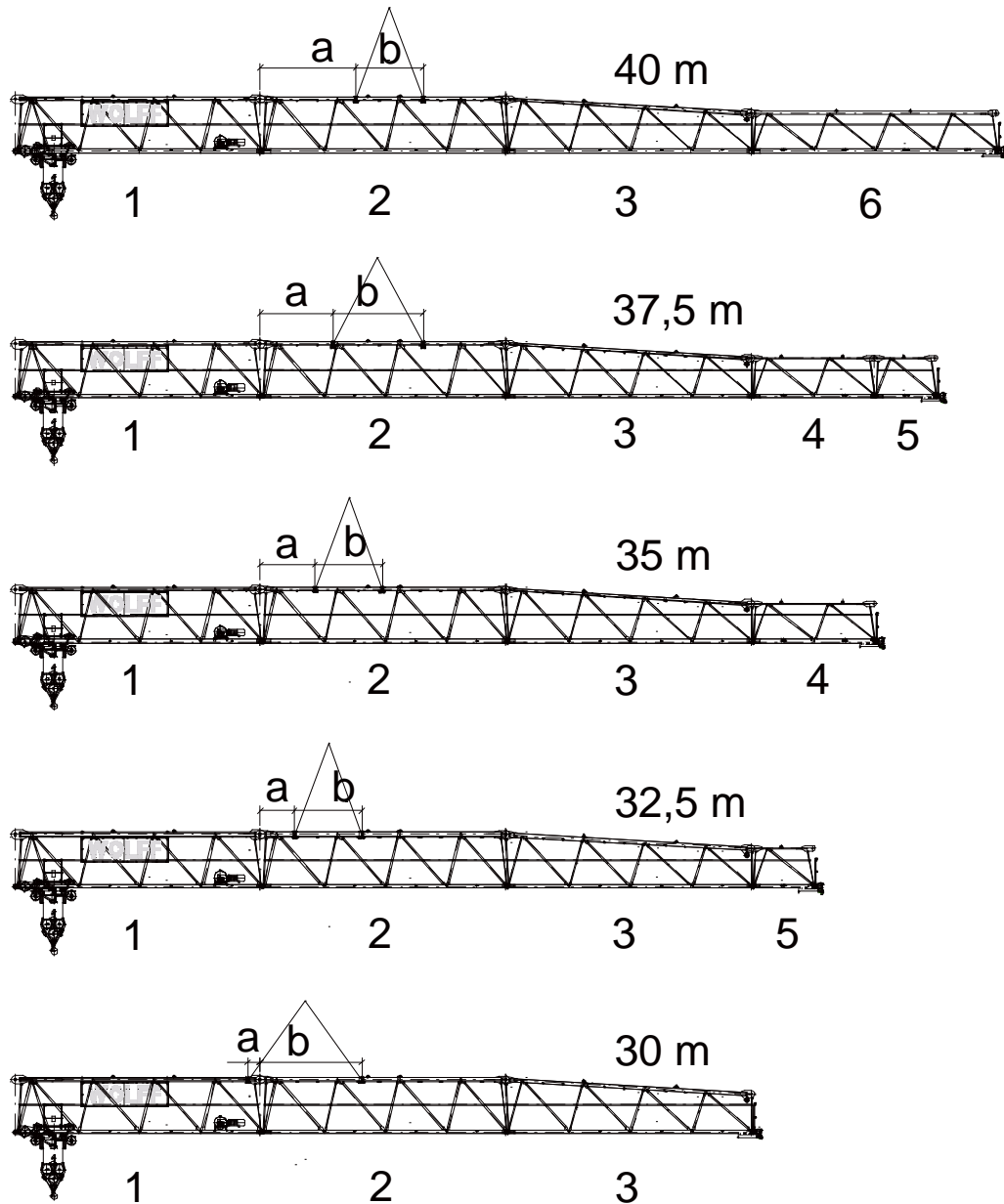

a	Dimension a
b	Dimension b

Data	Jib length [m]				
	40	37.5	35	32.5	30
a [mm]	3897	2965	2231	1397	515
b [mm]	2730	3662	2730	2730	4127
Weight [kg] 6031.12 clear	9500	9400	8900	8600	8100

7.2 Trolley jib mounting rig



NOTICE

For information on the arrangement of the mounting rig, refer to the attachment diagram.

Two mounting rigs are required per slewing tower crane.

Elements required for each mounting rig

Quantity	Item	Dimensions	Material
1	Mounting rig		
4	Hexagonal head bolt	M16 x 240	ISO 4017-8.8 galv.
8	HSFG washer	17	EN 14399 galvanized
8	Hexagonal nut	M16	ISO 4032-8 galvanized

Mounting rig

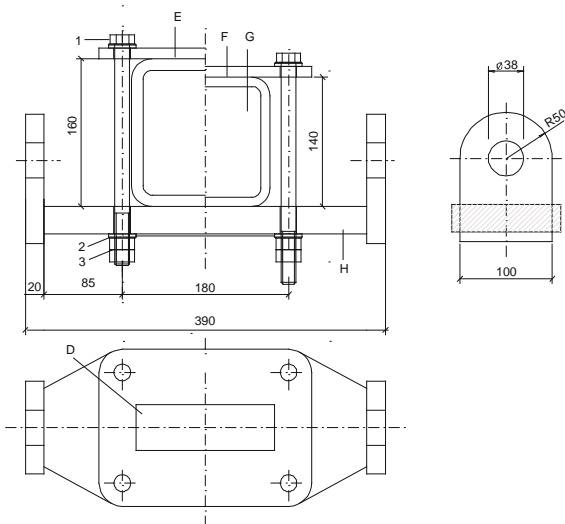

1	Hexagonal head screw	A	Mounting rig
2	HSFG washer	W	Top belt trolley jib
3	Hexagonal nut		

7.3 Arrangement of standard railings

7.3.1 Standard railings (NG) and accessories

Quantity *	Standard railings (NG)
3	Standard posts (NP)
1	F * (flag pole mount)
5	NG 500
2/ 1*	Standard railing750
4	Standard railing 1000
3/ 4(Standard railing2000
8	Standard railing2500
1	RS (hoop guard)
* HW875FU/ HW845FU	

7.3.2 Arrangement of standard railings

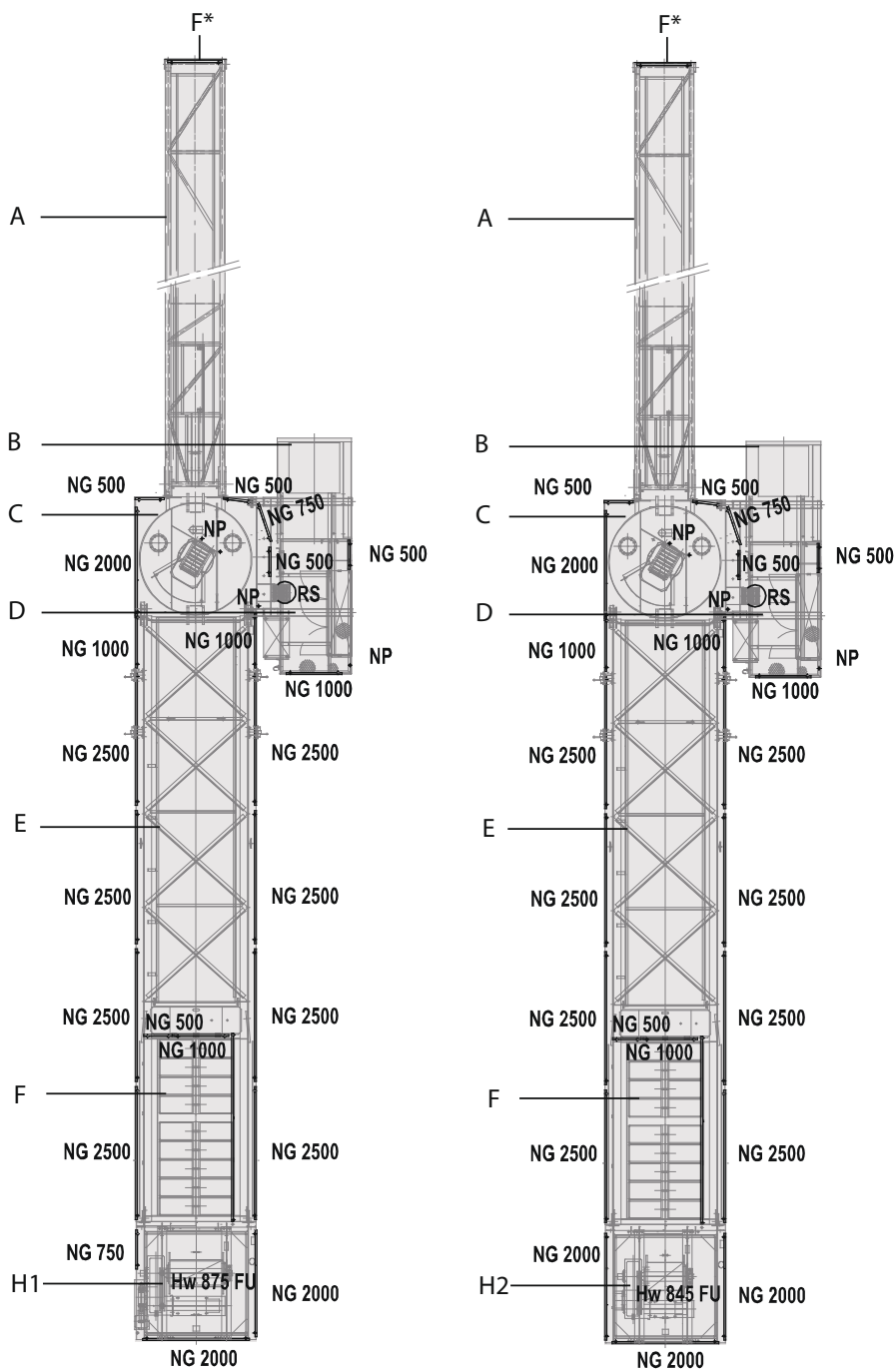

Arrangement of standard railings

A	Trolley jib	F	Counterweights
W	Driver's cab	H1	Hoist winch Hw875FU
C	Cat head pedestal	H2	Hoist winch Hw845FU
D	Control cabinet		

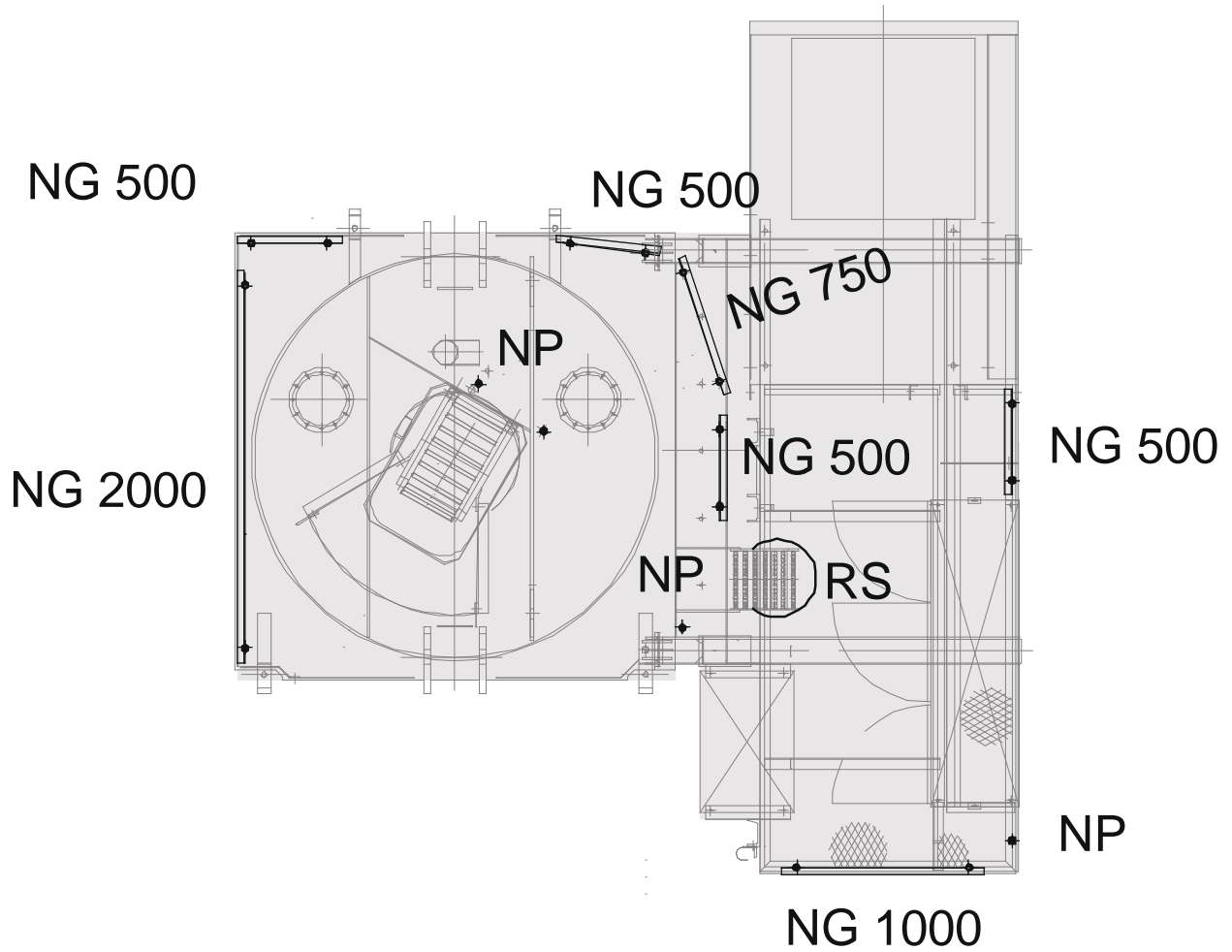

Arrangement of standard railings, tower head section

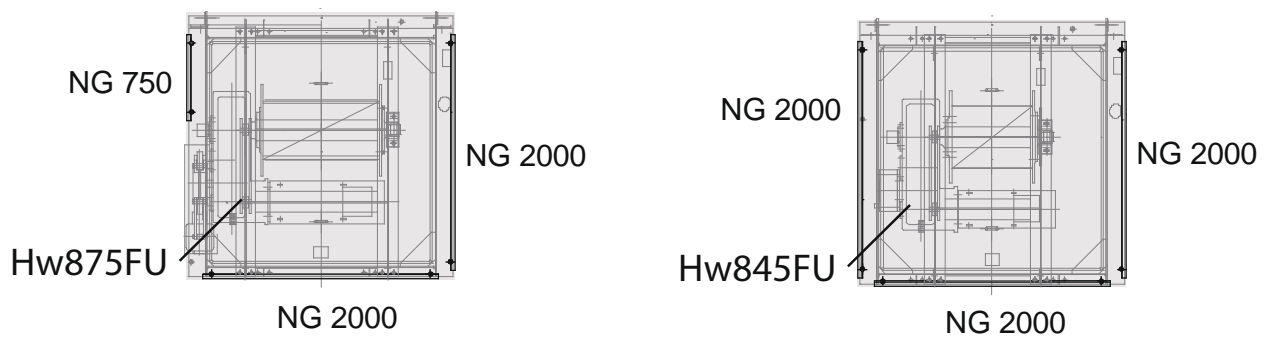





Arrangement of standard railings hoist winch

8 Suitable climbing frames



This section contains information on

- Outer climbing units
- Inner climbing units (KSH)

	<p>WARNING</p> <p>Climbing unit attached to the cat head bottom section Increased wind surface. The slewing tower crane may overturn.</p> <ol style="list-style-type: none"> 1) Lower the climbing unit down on the tower, or 2) dismantle the climbing unit.
	<p>NOTICE</p> <p>Clamping forces for the inner climbing unit (KSH) are specified based on a building height of < 250m and wind category C 25</p>
	<p>NOTICE</p> <p>The operating radius specified is measured from the tower center and is to be considered a reference value. Exact balancing can be achieved by moving the trolley with the tower elements specified in the table or a load and can be checked by moving the end stops of the tower apart without offsets.</p>
	<p>NOTICE</p> <p>The data required and the instructions for tower assemblies with inner climbing unit is available in the separate description of the inner climbing unit.</p>

DANGER! Observe the special tower combination for the inner climbing unit.

8.1 Outer climbing units

	<p>NOTICE</p> <p>If feasible, you should preferably operate your climbing frame without balancing weight.</p>
	<p>NOTICE</p> <p>Tower element on the transfer carriage</p> <p>The data on climbing balance was specified under the assumption that a tower element is on the transfer carriage.</p>

8.1.1 Outer climbing unit KWH 20.3/ KWH 20.3.1

	NOTICE
	<p>Minimum height for stationary setup: 3 tower elements = 13.5 m tower height</p> <p>Minimum height for crawling towers: 2 tower elements + bogie truck = approx. 13.5 m tower height</p>

Climbing radius for the balancing weights

6031.12	Jib length [m]														
	65	62.5	60	57.5	55	52.5	50	47.5	45	42.5	40	37.5	35	32.5	30
without Weight	21.3	37.5	36.6	45.5	42.5	-	-	-	-	-	-	-	-	-	-
UV 20 = 1.95 t	7.1	13.1	12.8	16.1	14.9	19.9	18.9	20.9	23.2	20.9	25.0	21.6	23.4	26.9	25.7
TV 20 = 3.05 t	-	9.1	8.9	11.4	10.6	14.4	13.7	15.2	17.0	15.2	18.4	15.8	17.2	20.0	19.0

8.1.2 Outer climbing unit KWH 20.6/ KWH 20.6.1

	NOTICE
	<p>Minimum height for stationary setup: 2 tower elements = 9.0 m tower height</p> <p>Minimum height for crawling towers: 2 tower elements + bogie truck = approx. 13.5 m tower height</p>

Climbing radius for the balancing weights

6031.12	Jib length [m]														
	65	62.5	60	57.5	55	52.5	50	47.5	45	42.5	40	37.5	35	32.5	30
no weight	19.4	35.5	34.7	43.6	40.5	-	-	-	-	-	-	-	-	-	-
UV 20 = 1.95 t	6.4	12.4	12.0	15.3	14.2	19.1	18.2	20.2	22.4	20.2	24.2	20.9	22.7	26.2	25.0
TV 20 = 3.05 t	-	8.6	8.3	10.9	10.0	13.9	13.1	14.7	16.5	14.7	17.9	15.2	16.7	19.4	18.5

8.2 Inner climbing units

8.2.1 Inner climbing frame KSH 20 SH

Tower combinations for slewing tower cranes with inner climbing unit.

Item				
1	UV 20.4	UV 20.4	UV 20.4	UV 20.4
2	UV 20.4	UV 20.4	UV 20.4	UV 20.4
3	UV 20.4	UV 20.4	UV 20.4	UV 20.4
4	UV 20.4	UV 20.4	UV 20.4	UV 20.4
5	UV 20.4	UV 20.4	UV 20.4	UV 20.4
6	UV 20.4	UV 20.4	UV 20.4	UV 20.4
7	TVA 20.4	UV 20.4	UV 20.4	UV 20.4
8		TVA 20.4	UV 20.4	UV 20.4
9			TVA 20.4	UV 20.4
10				TVA 20.4
Inner climbing unit	KSH 20 SH	KSH 20 SH	KSH 20 SH	KSH 20 SH
Foundation	Type F/S	Type F/S	Type F/S	Type F/S
Tower height [m]	46.5	51.0	55.5	60.0
Hook height (4-fall) [m]	47.6	52.1	56.6	61.1

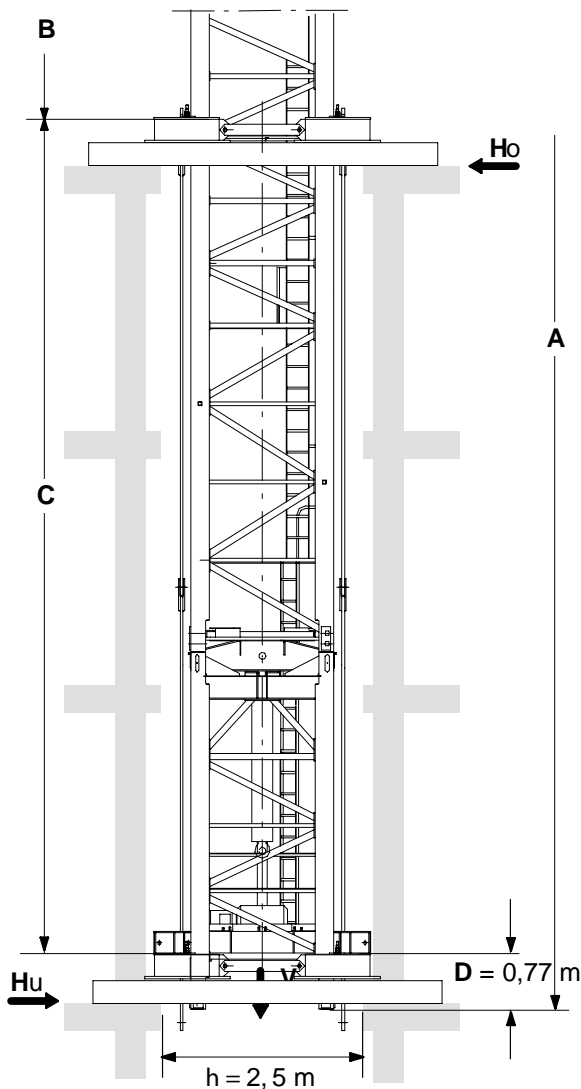

$$C_{\min} = 11,0 \text{ m}$$

$$C_{\max} = 14,0 \text{ m}$$

$$H_o = \frac{M}{C} + H$$

$$H_u = H_o - H$$

$$T = \frac{M_D}{2 \times b}$$

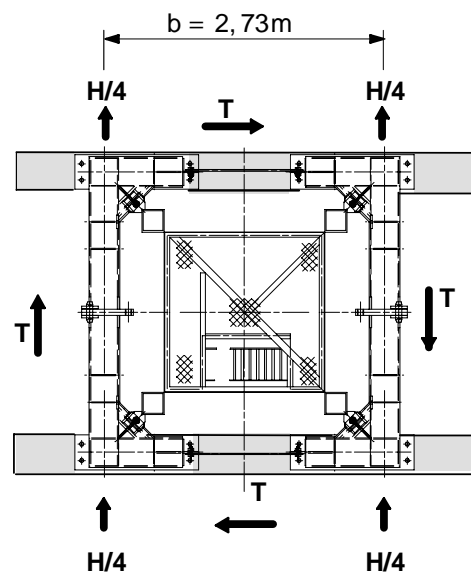

A	Tower height	C	Distance between guide frames
W	A-C-D		

Operational clamping forces

Operational clamping forces [kN] inside a building																
A [m]	60				55.5				51				46.5			
C [m]	11	12	13	14	11	12	13	14	11	12	13	14	11	12	13	14
V	1132				1113				1094				1075			
Ho	340	310	290	270	320	290	270	250	300	270	250	230	280	260	240	220
Hu	300	270	250	230	280	250	230	210	260	240	220	200	240	220	200	180
T	52				52				52				52			

Non-operational clamping forces

Non-operational clamping forces [kN] inside a building																
A [m]	60				55.5				51				46.5			
C [m]	11	12	13	14	11	12	13	14	11	12	13	14	11	12	13	14
V	100				981				962				943			
Ho	760	700	640	600	670	610	570	530	590	540	500	460	510	470	430	400
Hu	530	470	420	370	450	400	350	310	380	330	290	260	310	270	240	210
T	0				0				0				0			

9 Arrangement of counterweight blocks

L = 65 m	L = 62.5 m	L = 60 m	L = 57.5 m	L = 55 m
9 x 2.7 t	9 x 2.7 t	8 x 2.7 t	8 x 2.7 t	8 x 2.7 t
W = 28.0 t	W = 28.0 t	W = 25.3 t	W = 25.3 t	W = 25.3 t
L = 52.5 m	L = 50 m	L = 47.5 m	L = 45 m	L = 42.5 m
8 x 2.7 t	7 x 2.7 t	7 x 2.7 t	7 x 2.7 t	6 x 2.7 t
W = 25.3 t	W = 22.6 t	W = 22.6 t	W = 22.6 t	W = 19.9 t
L = 40 m	L = 37.5 m	L = 35 m	L = 32.5 m	L = 30 m
6 x 2.7 t	5 x 2.7 t	5 x 2.7 t	5 x 2.7 t	4 x 2.7 t
W = 19.9 t	W = 17.2 t	W = 17.2 t	W = 17.2 t	W = 14.5 t

Additional permanent counterweight for all jib lengths: 3.7 t

L	Jib length [m]	a	To the tower
G	Total weight [t]		Counterweight
	No counterweight		

