

QUY55 CRAWLER CRANE

OPERATION MANUAL



XCMG, CONSTRUCTION MACHINERY CO. LTD. BUILDING MACHINERY CO.

XUZHOU CONSTRUCTION MACHINERY GROUP CO., LTD., CHINA

QUY55 Crawler Crane

Operation Manual

Pages: 1 up to 78

Serial No.	
Date	

The operation manual is part of the crane!

Always keep it at hand for reference!

The design and manufacture of this equipment comply with the standard of Q/320301JAB007-2010 and GB/T14560-1993!

123456789101112131415161718192021222324252627282930313233343536373839404142434445464748495051525354555657585960616263646566676869707172737475767778798081828384858687888990919293949596979899100

C

O

O

O

Preface

Thank you for choosing QUY55 Crawler Crane designed and made by XCMG, Construction Machinery Co. Ltd., Building Machinery Co.

This manual introduces the correct operation, inspection and adjustment for QUY55 Crawler Crane. In order to give full rein to the crane high performance, please read, understand and use the operating instructions in this manual to ensure safety and high efficiency work for a long time.

Only the trained and qualified personnel can work on this crane.

Pay attention to periodic inspections of crane safety devices and don't use reluctantly the devices with any defects and abnormalities. What you should always keep in mind is *Safety First*.

Please keep the supplied technical documents and the manual carefully, and operate the machine according to instructions in them.

We reserve the right to modify the design without notice for improvement.

The right for explaining the manual belongs to XCMG, Construction Machinery Co. Ltd., Building Machinery Co.

Notes:

- 1) Read the manual carefully and familiar with operating procedures and notes before operate the vehicle. Otherwise, refill sufficient fuel and hydraulic oil according to the local environment and requirement of the actual operation, otherwise do not operate the crane.
- 2) Never extend hand and any part of body or clothing into the moving parts during operation. Keep power source far away from wet circumstance. Personal protective equipment (such as helmet, gloves and so on) has to be worn during operation.
- 3) Before starting, make sure that there is no unauthorized person around the machine. Only when there is no person within the dangerous area, the machine can be operated. Otherwise, never activate it.
- 4) This crawler crane is the crane for construction. The overall machine working class is A1. If it is need to carry out a piling operation with vibration or similar work, and as well as carry out a non-lifting operation such as scraper, grab and earth compaction, the contractor should negotiate with the crane manufacturer. Otherwise, it is the responsibility of crane owners, operators or customers to take any dangerous accidents and crane service life.
- 5) Keep the operation manual well for future reference.

XCMG, Construction Machinery Co. Ltd., Building Machinery Co.

April, 2011

G

O

D

O

Special Instructions for the Product Used in Low Temperature

1. The product is suitable for use at the ambient temperature $-20^{\circ}\text{C}\sim 40^{\circ}\text{C}$. Please stop use when the ambient temperature exceeds this temperature range, otherwise all the consequences will be taken by the users themselves.
2. For the engine equipped with a cold starting device, please use it when the ambient temperature is below 0°C . The engine cold starting device has three types: engine intake preheating, external power circulating water heating and fuel liquid circulating water heating. Please use the corresponding operation type according to the engine cold starting device equipped with the crane.
 - 1) For the crane equipped with Shanghai Diesel engine, the cold starting type is intake preheating. The intake preheating device must be reasonable operation, in order to play a warm-up effect. The intake preheating device begins to work when the ambient temperature is below 0°C . The counting starts from the key turned to "ON" position in starter switch, about 30 seconds of waiting time (specific to preheating lamp goes off). If the key is turned directly to "START" position, then the preheating function is automatically canceled.
 - 2) For the crane equipped with Cummins or Volvo engine, the cold starting type is external power circulating water heating. Use the cold starting device plug to connect with 220V power supply, the cold starting device will begin to work. Vice versa, to close the cold starting device. Use the cold starting device for heating about 30~40 minutes, the engine body temperature will be heated to about $20\sim 30^{\circ}\text{C}$, close the cold starting device, and then start the crane.
 - 3) For the crane equipped with YJH(A) series fuel liquid heater, the cold starting type is fuel circulating water heating. Press the heating button in operator's cab, the cold starting device will begin to work. Use the cold starting device for heating about 30~40 minutes, the engine body temperature will be heated to about $20\sim 30^{\circ}\text{C}$, close the cold starting device, and then start the crane.

Warning: When using the external power heating or fuel liquid heating for engine cold starting, before starting the crane, first de-energize the cold starting device, and then start the crane, otherwise there is a risk of damage to the crane engine.

Categories	Commonly used oil brands	Application range
Diesel oil	GB252 No.0 light diesel oil	4°C and above
	GB252 No.-10 light diesel oil	-5°C and above
	GB252 No.-20 light diesel oil	-14°C and above
	GB252 No.-35 light diesel oil	-29°C and above
Diesel and engine oil	CF-4 15W-40	-10°C ~ 40°C
	CF-4 10W-30	-30°C ~ 35°C
Hydraulic oil	L-HM46	-5°C and above
	L-HM32	-10°C and above
	L-HV22	-30°C and above
Industrial closed type gear oil	L-CKD 320	In Summer
	L-CKD 220	In Winter
Engine coolant	FD-I multi-effect engine coolant	-25°C and above

Attached table 1. Crane oil brands and application range

3. If the product is used at the low temperature, it is necessary to replace the various brands of oil used for the crane, otherwise it will cause the engine does not start or the system components have damages. Therefore, when using the product at the low temperature, please replace in advance the brands of oil strictly in accordance with the required temperature in Attached table 1.

Warning: In order to make normal use of the crane, please replace in advance the brands of oil strictly in accordance with the Attached table 1.

4. The other conditions not specifically described here on, please refer to the engine operation manual supplied with the crane, and carry out the routine service and maintenance of the engine in accordance with the requirement in the manual.

Contents

I. General Safe Operation Practice.....	1-1
1.1 Qualifications and duties of the operator.....	1-2
1.2 Signalman's responsibility.....	1-3
1.3 Responsibility of all crew	1-3
1.4 Responsibility of management.....	1-3
1.5 Requirements for safe operation	1-3
1.6 Precautions against wind.....	1-8
1.7 Planning the job.....	1-10
II. Description of the Crane	2-1
2.1 Applications and features.....	2-2
2.2 Main technical specifications.....	2-2
2.3 Safety devices.....	2-13
III. Crane Assembly and Disassembly.....	3-1
3.1 Basic machine assembly and disassembly	3-2
3.2 Notes on operation	3-2
3.3 Basic machine assembly procedure.....	3-3
3.4 Basic machine disassembly procedure	3-13
IV. Crane Operation.....	4-1
4.1 Electric system.....	4-2
4.2 Hydraulic system.....	4-7
4.3 Start and stop engine	4-7
4.4 Control levers	4-8
4.5 Winch operation	4-8
4.6 Elevating operation.....	4-9
4.7 Slewing operation	4-9
4.8 Travel operation	4-10
4.9 Crawler telescopic cylinder operation.....	4-10
4.10 Indication plates.....	4-10
V. General Cautions in Operation.....	5-1
5.1 Main cautions	5-2
5.2 Cautions in handling winch rope.....	5-9
VI. Transport.....	6-1

6.1 Short distance site transfer.....	6-2
6.2 Long distance site transfer.....	6-2
6.3 Transport planning.....	6-3
VII. Customer Acceptance Items.....	7-1



I. General Safe Operation Practice

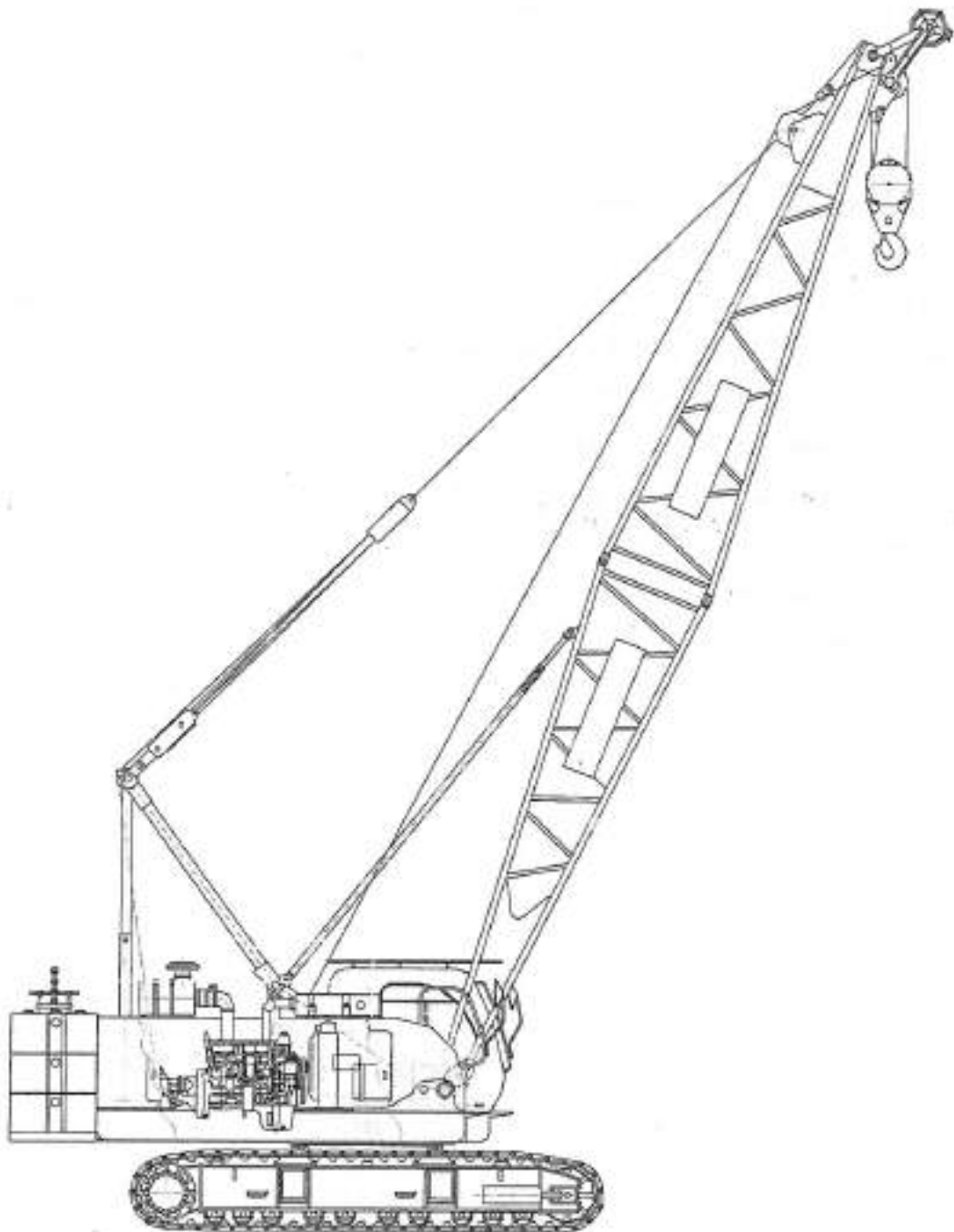



1.1 Qualifications and duties of the operator

(1) Operator

The crane should be operated by:

- a. Persons who are qualified by training and technical examination;
- b. Trainees who study under the supervision of qualified operators more than half year;
- c. Service personnel and tester who are expected to fulfill the given tasks;
- d. Safety supervisors who are appointed by the leader.

(2) The operator should:

- a. Be aged 18 years and older, both physically and mentally capable;
- b. Have eyesight of more than 0.7 (include the one corrected), and be not color-blind;
- c. Have the hearing that meet specific working condition;
- d. He must be alert, physically fit, and free from the influences of alcohol, drugs, or medications that might affect his eyesight, hearing, reactions and judgment.

(3) The operator should familiar with the following:

- a. Structure and technical performances of all mechanisms of the crane to be operated;
- b. Crane operating instructions, the manual and relevant legal regulations;
- c. Requirements for safe operation;
- d. Safety and protecting device's performance;
- e. Basic knowledge about engine and electric equipments;
- f. Signals;
- g. Basic knowledge about maintenance and service.

(4) Duties of the operator:

- a. He must be alert. He must refuse to operate when he knows it is unsafe, and consult his supervisor when safety is in doubt.
- b. He must read and understand the 'Operator's Manual' and see that the machine is in proper order (especially the tightness of slings and rope sockets) before operating.
- c. He must understand how to read the lifting load table and know that his machine can safely lift each load before attempting to lift it.
- d. He should check the job site in person before operation. He must see that unnecessary people, equipment, and material are kept out of the working area. The area around the machine should be properly barricaded.
- e. Operators must understand standard crane signals and take signals only from designated signalmen.
- f. Operators must respond to emergency stop signal whenever and whoever sent.
- g. Operator must not leave the crane unattended during working.



1.2 Signalman's responsibility

- a. The primary duty of a signalman is to assist the operator in safe and efficient operation. Operators depend on designated signalmen to assist them in making movements without endangering people or property.
- b. Signalmen must have good vision and sound judgment, know standard crane signals and be able to give signals clearly.
- c. Signalmen must have a clear understanding of the work to be done so that they can safely coordinate each job with operators and crew.
- d. Signalmen must place themselves where they can be clearly seen and where they can safely observe the entire operation. Standard crane signals must be used unless other methods of signaling such as two way radios or flags have been agreed upon.
- e. They must have enough experience to be able to recognize hazards and signal the operator to avoid them.

1.3 Responsibility of all crew

- a. Inspect the tightness of slings and rope sockets.
- b. Any unsafe condition or practice must be corrected or reported to the job supervisor.
- c. Everyone who works around the crane, including riggers and maintenance personnel, must obey all warning signs and watch out for his own safety and the safety of others. Crew setting up machines or handling loads are expected to know proper machine erection and rigging procedures.
- d. Watch out for hazards during operations and alert the operator and signalmen of dangers such as power lines, the unexpected presence of people, other equipment or unstable ground conditions.

1.4 Responsibility of management

- a. See that operators are trained, competent, physically fit and, if required, licensed. Good vision is required, as are good judgment, coordination and mental ability. Any person who lacks any of these qualities must not be allowed to operate a crane.
- b. Riggers must be trained to determine weights and distances and to select proper lifting tackle. It is management's responsibility to employ qualified riggers.
- c. Crew must be given specific safety responsibilities and instructed to report any unsafe conditions to their supervisors.

1.5 Requirements for safe operation

(1) General requirements

- a. **Danger: operators must take signals only from designated signalmen. Operators must respond to emergency stop signal whenever and whoever sent.**



- b. **Caution:** check pawls, wire ropes, hook blocks and safety devices, and if abnormality is found, remove it before operation.
- c. **Caution:** before leave the machine unattended, operator must lower the load on the ground, set slewing and elevating brakes or locks, stop engine. And approximate 70° of main boom angle should be positioned under main boom working condition.
- d. **Note:** bell or alarm must be sounded before start the machine. When approach person during operation, intermittent bell or alarm should be used.
- e. **Note:** when there is no person on the crane or around it, power source could be turned on.
- f. **Note:** position all control levers to neutral before turn on power source.
- g. **Note:** move all control levers to neutral if power fails abruptly during operation. Check crane motions for correctness before reuse it.
- h. **Note:** prior to servicing the crane, turn off power and place "Warning or out of order" signs on the crane controls. If there is any trouble unsolved, notify the operator next shift.

(2) Technical requirements

- a. **Danger:** operator should not operate the crane if any one of the following occurs:
 - 1. **Overloading or load weight unknown.** Such as lift or pull a load stuck, side-load or drag a load on the ground, etc.
 - 2. **Defects or damage on structural parts or components, which affect safe operation.** For example: brake, safety devices out of order, anti-loose device of hook block nut damage, wire rope damage to discard standard.
 - 3. **Load slides due to loose or unbalance binding, and no liner applied between the edge of load and wire rope.**
 - 4. **There is person or floating body on the load to be lifted.**
 - 5. **It is too dark to see job site, the load to be lifted and signals clearly.**
- b. **Danger:** during operation, operator should observe the following:
 - 1. **Never stop the machine by using limiter.**
 - 2. **Never move loads over people, no person is allowed under the boom.**
 - 3. **Don't carry out maintenance and service while the crane is running.**
 - 4. **If the load to be lifted is approaching or up to the rated lifting capacity, check brake and make a trial lift of short distance and height before lifting operation.**
 - 5. **The following improper operations should be avoided:**
 - ◇ Slewing too fast;



- ◇ Apply abrupt brake during lifting operation;
- ◇ Pull a load on the ground sideways (slew or propel);
- ◇ Disorder wire rope on drum;
- ◇ Propel fast with a load suspended;
- ◇ Perform lifting operation with crane set on uneven ground;
- ◇ Suspended load rotating;
- ◇ Poor binding of load;
- ◇ Hit bridge, ceiling or power line.

(3) Operation precautions

1. **Danger:** mistakes in calculating lifting capacity can cause accidents. So the following should be taken into consideration:
 - ① Working radius. Note that the working radius will increase when the load is lifted up.
 - ② Weight of the load, hooks and slings.
 - ③ Boom length, working radius and parts of line and lifting capacity.
 - ④ Use the next lower rated capacity when working at boom lengths or radius between the figures on the rating chart. It is dangerous to guess the capacity for boom lengths or radius between those listed on the rating plate.
 - ⑤ Trying to lift a load without knowing whether it is within the rated capacity while expecting the crane to start to tip to warn of an overload is very dangerous and should never be done. Cranes may suddenly tip over or collapse if the load is too heavy.
 - ⑥ Overload is not permitted.
2. **Danger:** when two cranes are needed to lift a load, select cranes with similar performance. During operation, cranes should be directed and coordinated untidily, and the axle loads should be distributed reasonably. The lifting load should not exceed 75% of the total lifting capacity that two cranes can bear in this working condition. The lifting load for one crane should not exceed 80 % of its rated lifting capacity. Before operation, a written planning is required.
3. **Danger:** during lifting operation, mast must be raised up and backstop bar be used.
4. **Danger:** cranes may tip over or collapse if the operating surface can't support their weight. Timber mats, steel plates may be needed under crane to distribute the load under it so that the bearing strength of the ground is not exceeded.
5. **Danger:** never place crane on sewer or underground pipeline or air-raid shelter.
6. **Danger:** avoid overloading, side loading and lifting load sideways. Trying to lift a load



that is stuck, frozen or attached to something else may result in tipping, boom collapse or other damage. Be sure that loads are free before lifting.

7. **Danger:** never use the crane as a lifter for transferring person.
8. **Danger:** when operate crane near power electrical lines, the safe clearances keeping any part of crane from the lines should comply with those shown in Table 1-1, otherwise serious injury or death will occur, and then consequent power failure accidents such as civil electricity, electricity for hospital endangering patient, civil airport and traffic chaos and factory stopping work.
9. **Danger:** precautions against lightning and earthquake
 - ① Stop the work, and lower the load onto the ground. Position the boom on the ground too if there is enough space.
 - ② Engage the brakes and pawls, stop the engine, and turn off the electrical power of all electric circuits.
 - ③ Advise all personnel to stay away from the surrounding area of the machine.
10. **Caution:** the rated capacity of a crane is determined with the crane set on a firm ground which grade not more than 5%. Never slewing with a load when the crane is set on a slope with more than 1% of grade.
11. **Caution:** no person and objects piled are permitted within slewing radius.
12. **Caution:** in principle, propelling a crane with a load suspended is prohibited. If it is necessary, the following must be observed:
 - ① The operation must be under main boom working condition.
 - ② The ground must be firm, level, and no potential to sink, and slope less than 5%.
 - ③ The lifting load should not exceed 70% of the rated lifting capacity under corresponding working condition.
 - ④ Travel with slow speed, boom over front and a height of 250mm above the ground should not be exceeded.
 - ⑤ In process of traveling, if it is necessary to make a turn, the load suspended must be lowered on the ground. After turning, pick and carry the load and slew it over front for forward traveling.
 - ⑥ It is prohibited to travel a crane with a load suspended under jib working condition.
13. **Caution:** avoid the hook block contacts the end of the boom while carry out elevating operation.



Table 1-1 minimum distance between boom, load and overhead electrical wires

Voltage of power lines (kV)	$V < 1$	$1 < V \leq 15$	$15 < V \leq 40$	$40 < V \leq 100$	$100 < V \leq 220$
Safety distance (m)	1.5	3	4	5	6

14. Emergency methods when electrical accident occurs

- ① Notify the electrical power company immediately.
- ② **Danger:** Don't panic, move the crane and the load away the power line. If it is impossible, the safest procedure for the operator is to stay at his post until the contact is cleared, or the power has been shut off. If the operator must leave the machine, he should jump off, rather than climb off.
- ③ In case someone gets electric shock, artificial respiration and heart massage must be carried out at once.
- ④ **Danger:** If the lines are broken, inform people around to keep out the lines and barricade this area.
- ⑤ **Note:** After an accident, if reuse the crane, inspect all instruments.

15. Note: during slewing operation with a full load, it is better to keep the load close the ground as near as possible and retain min. working radius.

16. Danger: step voltage protection. Step voltage is generally formed by high-voltage power line landing on the ground, and the voltage gradually reduces from the landing point to peripheral area, so the best way to leave the voltage with both feet synchronous jumping away, try to keep both feet flush to reduce the hazards of step voltage.

(4) Warning: safety check items

The operator must make a safety check before starting to work each day to see that the machine is in proper order. The checklist is as the following:

- 1. Check the machine log to see that periodic maintenance and inspections have been performed and all necessary repairs made.
- 2. Check the operation of safety devices and indicators.
- 3. Carefully inspect load-bearing parts, fasteners and weld joints.
- 4. Check the wear of wire ropes, slings and hooks.
- 5. Be sure no unauthorized field modifications have been made, such as counterweights increased or decreased and booms that have been improperly repaired.
- 6. Check for fuel and hydraulic oil leaks.
- 7. Test all controls for proper operation.



8. After starting the engine, check all gauges for proper readings.
9. Check the operation of brake and clutch.

1.6 Precautions against wind

(1) Influence of wind

Influence of the wind on the machine becomes larger in proportion to the size of a lifted load, lifting height, and boom length. Especially, the following cases are very dangerous, so utmost care is necessary for operation.

- ① When lifting a load of wide area, against which the wind blows hard, the wind could cause the overturn of the machine and damage to the boom. The wind could also blow the load against the boom, and could cause damage.
- ② When the boom is fully raised without a load, the wind could blow the boom backward resulting in an overturn of the machine.

(2) Cautions for wind

When performing crane operation in strong wind, utmost cautions are required according to the wind velocity, machine condition and working environment. The wind velocity on the ground is different with that in the high air. It is also different on flat ground and in city air. Always considering these conditions and taking proper measures to meet the situation. The wind velocity mentioned here means the instantaneous wind (for the following chapters as well).

(3) Method of wind velocity measurement

The position where the wind works against the machine is the height above the ground that corresponds to 60% of the boom length at that time. Since the wind velocity of the weather report is the average wind speed for 10 minutes at a height of 10 meters above the ground, it is necessary to convert it into the instantaneous wind speed (refer to Table 1-2).

1. An instantaneous anemometer is provided on the boom tip of the machine, the reading could be gotten from the display of LMI.
2. If the instantaneous anemometer fails, refer to the instantaneous anemometer on other building or the wind velocity given by a weather report can be converted to the instantaneous wind speed.
3. The instantaneous wind speed can be estimated by wind speed description (see Table 1-3).



Table 1-2 conversion table of wind velocity

Wind velocity of weather report (m/s) Height above ground (m)	3				5				8				10			
	Flat area		City area		Flat area		City area		Flat area		City area		Flat area		City area	
	Av.	Inst.	Av.	Inst.	Av.	Inst.	Av.	Inst.	Av.	Inst.	Av.	Inst.	Av.	Inst.	Av.	Inst.
5	2.7	9.8	2.5	10.0	4.5	11.7	4.2	11.4	7.1	14.5	6.7	14.0	8.9	16.3	8.4	15.8
10	3.0	10.2	3.0	10.2	5.0	12.3	5.0	12.3	8.0	15.4	8.0	15.4	10.0	17.5	10.0	17.5
15	3.2	10.4	3.3	10.5	5.4	12.7	5.6	12.9	8.6	16.0	8.9	16.3	10.7	18.2	11.1	18.7
20	3.4	10.5	3.6	10.8	5.6	12.9	6.0	13.3	9.0	16.5	9.5	17.0	11.2	18.8	11.9	19.5
25	3.5	10.7	3.8	11.0	5.9	13.2	6.3	13.6	9.4	16.9	10.1	17.6	11.7	19.3	12.6	20.2
30	3.6	10.8	4.0	11.2	6.0	13.3	6.6	13.9	9.6	17.1	10.6	18.1	12.0	19.6	13.2	20.9
40	3.8	11.0	4.2	11.5	6.3	13.6	7.1	14.5	10.1	17.6	11.3	18.9	12.6	20.2	14.1	21.8
50	3.9	11.1	4.5	11.7	6.6	13.9	7.5	14.9	10.5	18.0	12.0	19.6	13.1	20.8	15.0	22.8
75	4.2	11.4	5.0	12.2	7.0	14.4	8.3	15.7	11.2	18.8	13.2	20.9	14.0	21.7	16.5	24.8
100	4.4	11.6	5.3	12.6	7.4	14.8	8.9	16.3	11.8	19.4	14.2	21.9	14.7	22.4	17.8	26.7

Table 1-3 wind speed description

Wind speed (m/s)	Name	Beaufort number	Effects observed on land
≤0.3	Calm	0	Calm; smoke rises vertically.
0.3~1.6	Light air	1	Smoke drift indicates wind direction.
1.6~3.4	Light breeze	2	Wind felt on face; leaves rustle.
3.4~5.5	Gentle breeze	3	Leaves, small twigs in constant motion, light flags extended.
5.5~8.0	Moderate breeze	4	Dust, leaves and loose paper rises up.
8.0~10.8	Fresh breeze	5	Small trees in leaf begin to sway, and there are waves on the surfaces of pool and natural pond.
10.8~13.9	Strong breeze	6	Larger branches of trees in motion, whistling heard in wires; umbrella uneasy to open.
13.9~17.2	Moderate gale	7	Whole trees in motion; resistance felt in walking against wind.
17.2~20.8	Fresh gale	8	Twigs and small branches broken off trees; progress generally impeded.
20.8~24.5	Strong gale	9	Slight structural damage occurs (chimney broken, slate blown from roofs).
24.5~28.5	Whole gale	10	Trees broken or uprooted; considerable structural damage occurs.
28.5~32.7	Storm	11	Very rarely experienced on land; usually accompanied by widespread damage.
≥32.7		12	

(4) Danger: precautions against wind

1. When the wind velocity exceeds 9.8m/sec. stop operation and do the following:

- a. Lower the load onto the ground and release hook block.
- b. Change the boom angle to the range of 60°~70°.



- c. Let the back of boom against wind by slewing the turntable.
 - d. Engage all brakes and ratchets, and insert turntable lock pin.
 - e. Stop engine.
2. When the wind velocity exceeds 14 m/s, the operation shall be stopped:
- a. Lower the load onto the ground and release hook block.
 - b. If it is necessary to swing the turntable, change the boom angle to the range of $60^{\circ}\sim 70^{\circ}$ before swinging.
 - c. Lower the boom onto the ground
 - d. Engage all brakes and ratchets, and insert the turntable lock pin.
 - e. Stop engine.
3. When the wind velocity is estimated to be more than 25m/s, lower the boom onto the ground before the wind coming.

1.7 Planning the job

- (1) Two preconditions for safe operation are well-conditioned equipment and trained operator.
- (2) Most accidents can be avoided by careful job planning. The person in charge must have a clear understanding of the work to be done and equipment capabilities. He must consider all dangers at the jobsite, develop a plan to do the job safely, and then explain the plan to all concerned. Factors such as these should be considered:
 - a. What crew is needed and what responsibilities will they be given?
 - b. Operation type and site (distance), transport road height limit and road width.
 - c. How can the equipment be safely transported to the jobsite?
 - d. What's the weight and volume of load to be lifted, working radius, boom length and angle, and crane lifting performance?
 - e. How will the signalmen communicate with the operator?
 - f. What equipment is required to do the job safely? Is a crane the best equipment for the job?
 - g. Are there gas lines, power lines or structures that must be moved or avoided?
 - h. Is the surface strong enough to support the machine and load?
 - i. How will loads be rigged?
 - j. What special safety precautions must be taken if more than one crane is needed to lift a load?
 - k. What safety precautions must be taken when encounter unusual weather conditions such as winds, extreme cold, rain and snow?
 - l. What steps will be taken to keep unnecessary people and equipment safely away from the work area?



Warning: the “suitable”, “must” mentioned in the Operation Manual is closely related with the actual environment description, the operator has the responsibility to make a reasonable choice according to the actual situation, or contact the manufacturer.



Memorandum



II. Description of the Crane

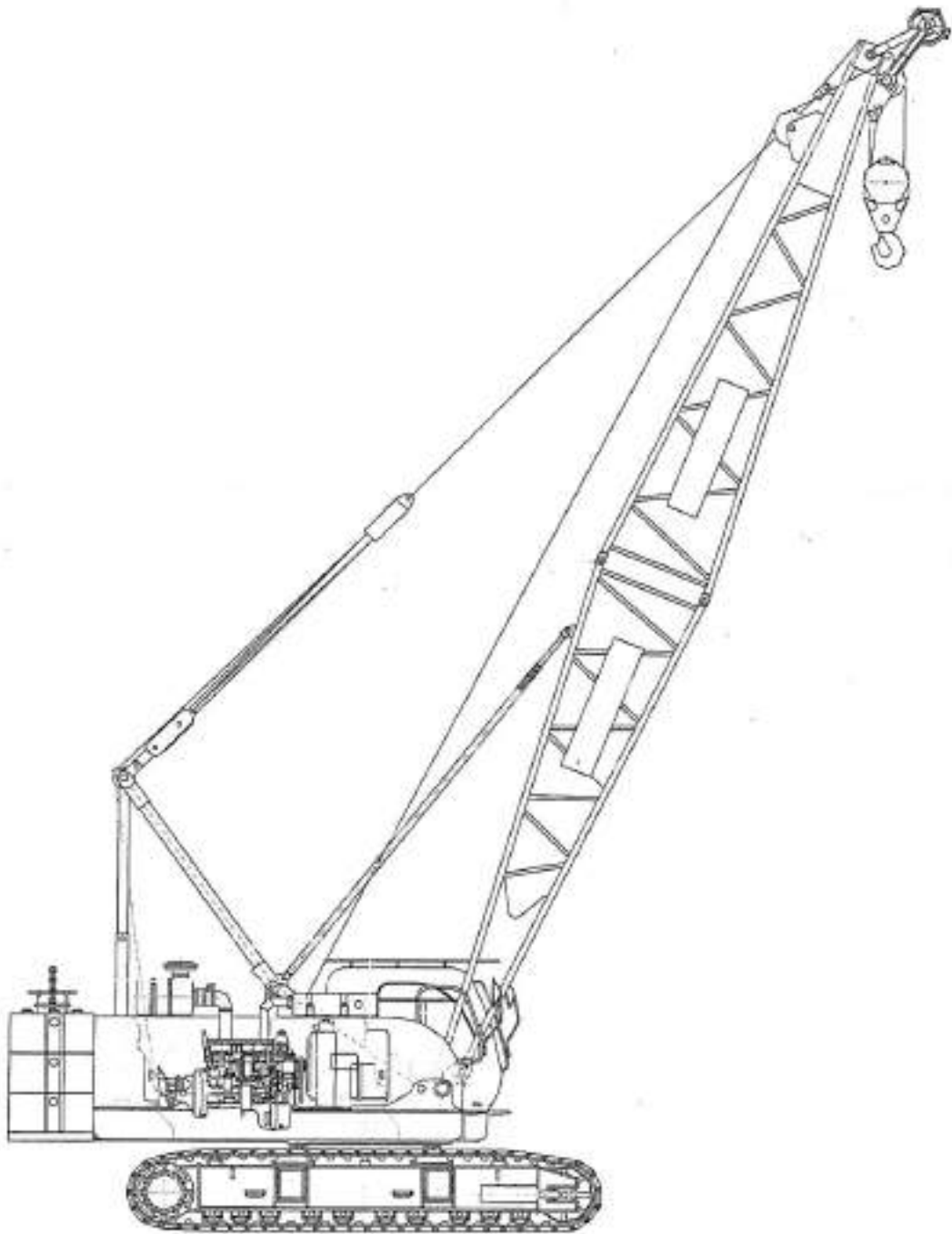



2.1 Applications and features

QUY55 crawler crane is updated on the basis of QUY50 crawler crane and with combination of international and domestic market conditions. Compare to the old model, this crane has improvement on load-lifting performance, single line pull and winch speed. It features excellent lifting performance, travel with load, 360° swing operation and extendable crawler. The boom length is 13m~52m, and the fixed jib length is 9.15m~15.25m.

QUY55 crawler crane has wide range of application, and is suitable for lifting and installation work in construction sites, mines and dock warehouses, especially for bad ground condition that other lifting equipment cannot replace.

2.2 Main technical specifications

2.2.1 Crane outline and specifications

(1) Applications

a. Range:

Loading /unloading operations and installation work in plants, mines, construction sites. It is not suitable to be used in strong electric magnetic area.

b. Conditions:

Ambient temperature: -20~40℃

Wind speed: boom length \leq 50m, wind speed \leq 13.8m/s (scale 6); boom length > 50m, wind speed \leq 9.8m/s (scale 5).

Ground condition: firm, level and the ground gradient no more than 1%.

(2) Crawler crane outline refer to Fig. 2-1.

(3) Main technical specifications refer to Table 2-1.

(4) Total rated lifting load for boom refer to Table 2-2.

(5) Total rated lifting load for fixed jib refer to Table 2-3.

(6) Crane working areas refer to Fig. 2-2.

(7) Relation among boom length, parts of line and rated lifting load refer to Table 2-4

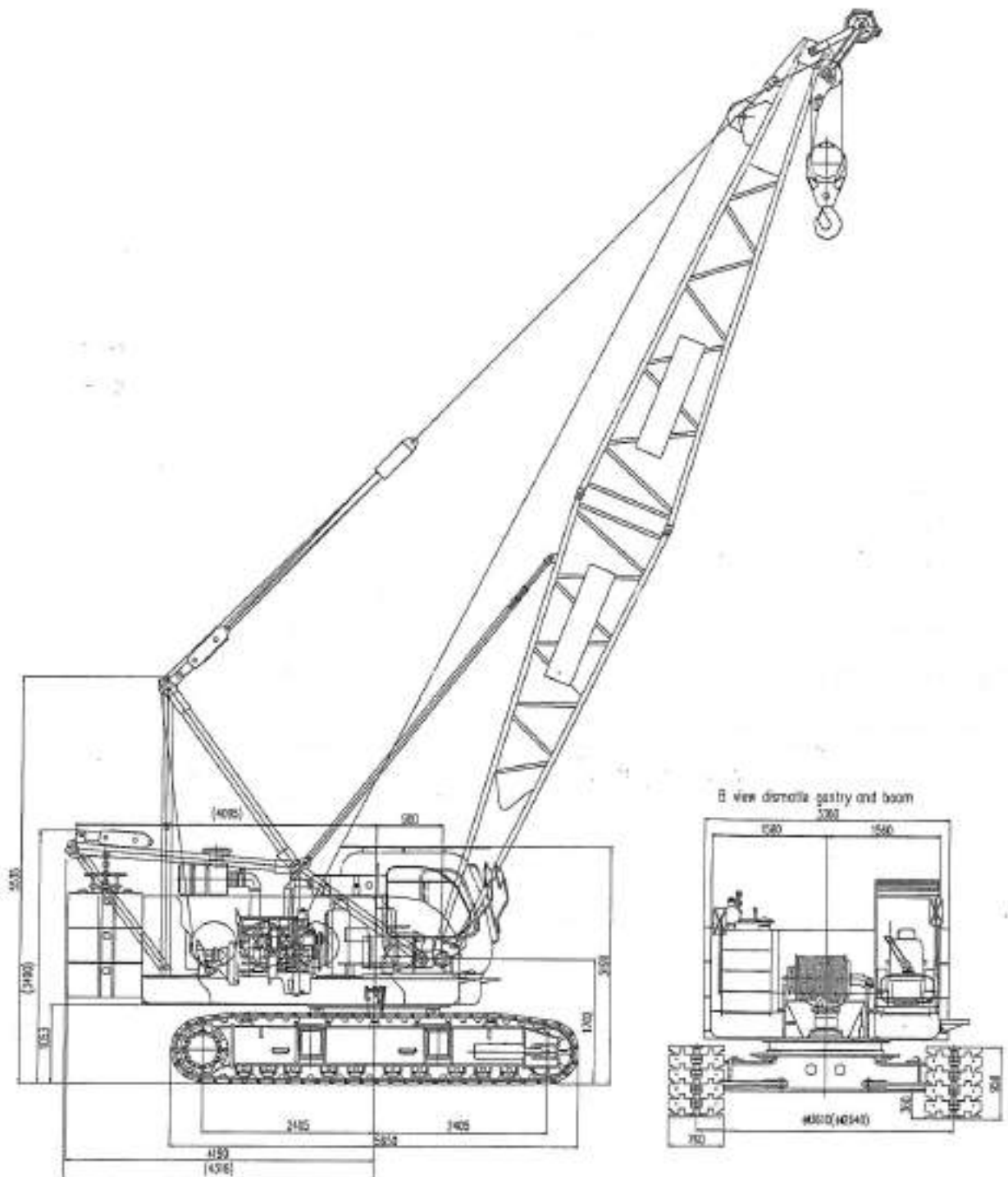

F

fig. 2-1 crawler crane outline

Dimensions in () brackets are for retracted mast and crawler



Table 2-1 main technical specifications

Item		Unit	Data
Max. rated lifting capacity	Basic boom	t	55
	Fixed jib	t	5
Max. load moment		t.m	203.5
Main boom length		m	13~52
Main boom angle		°	30~80
Fixed jib length		m	9.15~15.25
Winch max. single line speed (no load, at 5th layer)		m/min	121
Boom elevating gear max. single line speed (at 1st layer)		m/min	63
Max. swing speed		r/min	1.5
Max. travel speed		km/h	1.35
Grade ability			40 %
Mean ground pressure		MPa	0.069
Engine output power		kW	128
Gross vehicle weight (with main hook block and 13mboom)		t	51
Max. weight of single unit in travel configuration		t	31
Max. dimension of single unit in travel configuration (L×W×H)		m	11.5×3.47×3.4

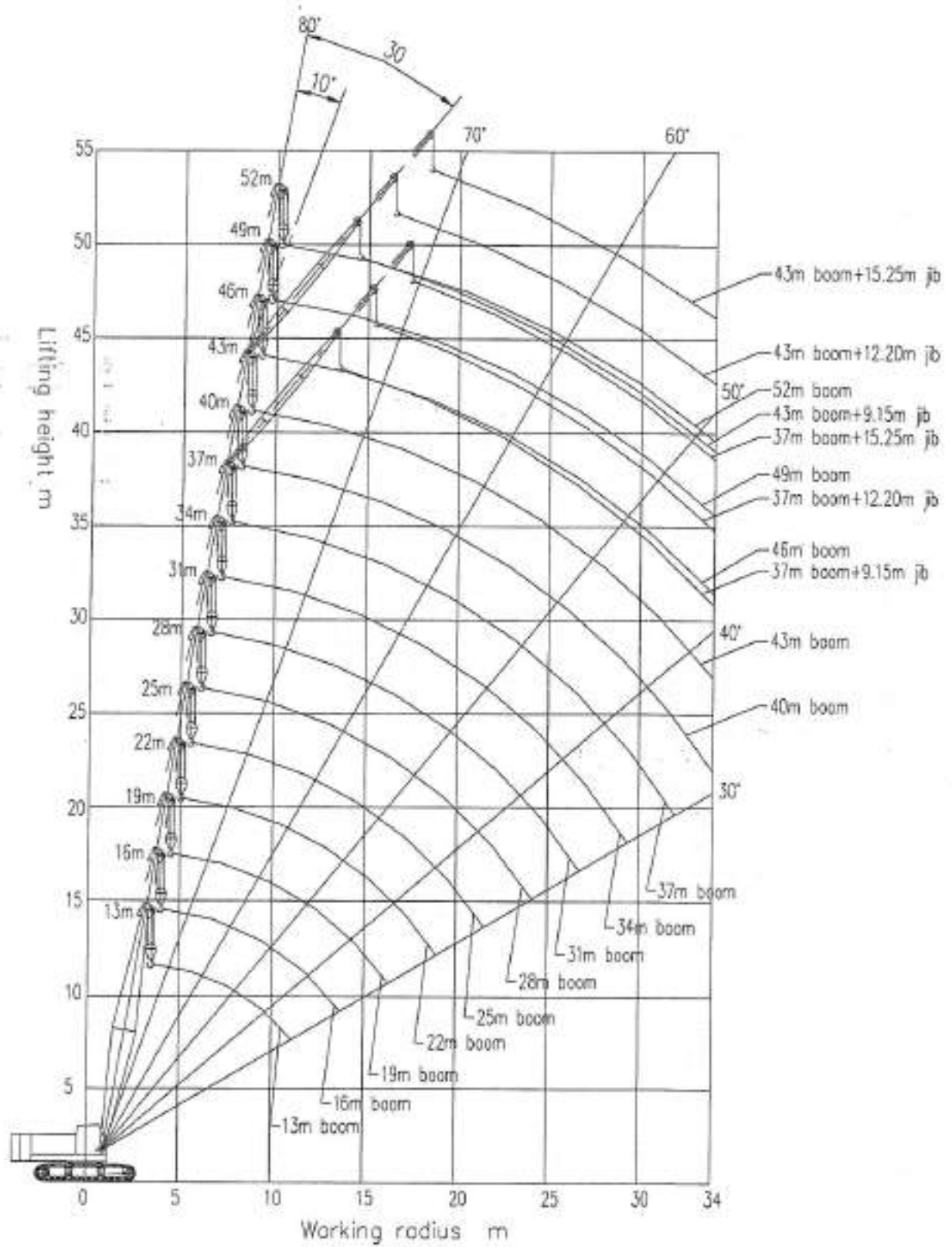

Fig. 2-2 crawler crane working radius



Table 2-2 total rated lifting load for boom

Unit: t

Boom length Radius	13(m)	16(m)	19(m)	22(m)	25(m)	28(m)	31(m)	34(m)	37(m)	40(m)	43(m)	46(m)	49(m)	52(m)
3.7(m)	55.00													
4.0(m)	50.00	48.00												
4.5(m)	42.00	41.50	40.00											
5.0(m)	35.20	35.00	34.60	33.00										
5.5(m)	31.20	31.00	30.80	30.00	28.00									
6.0(m)	27.80	27.50	27.20	26.90	26.00	25.00								
7.0(m)	22.50	22.20	22.00	21.80	21.50	21.00	20.00							
8.0(m)	19.00	18.90	18.50	18.30	18.20	17.80	17.40	17.00	16.60					
10.0(m)	14.00	13.90	13.80	13.70	13.60	13.50	13.30	13.00	12.60	12.40	12.00	11.60	11.30	
12.0(m)	11.20	11.10	11.00	10.80	10.70	10.50	10.60	10.40	10.20	9.90	9.50	9.20	9.10	9.10
14.0(m)		9.20	9.10	9.00	8.90	8.70	8.60	8.50	8.40	8.10	7.90	7.60	7.30	7.30
16.0(m)			7.80	7.50	7.40	7.30	7.20	7.10	7.00	6.80	6.50	6.30	6.10	6.10
18.0(m)				6.50	6.40	6.30	6.20	6.10	6.00	5.80	5.70	5.40	5.20	5.00
20.0(m)				5.60	5.50	5.40	5.30	5.20	5.10	4.90	4.80	4.60	4.30	4.20
22.0(m)					4.80	4.70	4.50	4.40	4.20	4.10	4.00	3.80	3.60	3.50
24.0(m)						4.00	3.90	3.80	3.60	3.50	3.40	3.20	3.10	2.90
26.0(m)							3.50	3.30	3.20	3.10	2.90	2.80	2.60	2.40
28.0(m)								2.90	2.80	2.60	2.40	2.30	2.20	1.90
30.0(m)								2.50	2.40	2.20	2.00	1.80	1.60	1.50
32.0(m)									2	1.90	1.70	1.60	1.30	1.20
34.0(m)										1.60	1.20	1.10	1.00	0.90

Notes:

1. The unit of lifting load in the above table is ton.
2. The crawler track must be extended before lifting operation and the crane should be set up on firm and level ground.
3. The lifting loads in the table include the weight of slings and attachment.
4. The lifting load in the table does not exceed 75% of tipping load.
5. The lifting load should be subtracted 2.5t when jib is attached on boom head, the lifting load should be subtracted 0.4t when single top is attached on boom head and boom length should be less than 49m and the weight of single top should be less than 4t.



Table 2-3 total rated lifting load for fixed jib

Unit: t

Boom length (m)	25						28						31						34					
	9.15		12.20		15.25		9.15		12.20		15.25		9.15		12.20		15.25		9.15		12.20		15.25	
	10	30	10	30	10	30	10	30	10	30	10	30	10	30	10	30	10	30	10	30	10	30	10	30
Jib angle (°)	10	30	10	30	10	30	10	30	10	30	10	30	10	30	10	30	10	30	10	30	10	30	10	30
Radius(m)	5.00						5.00										5.00							
9																	5.00							
10			4.50				5.00										5.00							
11			4.50		4.00		5.00			4.00							5.00			4.00				
12			4.50		4.00		5.00	5.00		4.00							5.00	4.80	4.50	4.00				3.50
13			4.80	4.50	4.00		5.00	5.00		4.00							5.00	4.80	4.50	4.00				3.50
14			4.60	4.50	4.40	3.50	5.00	4.80		3.80	3.50						5.00	4.70	4.50	4.00				3.50
15			4.50	4.40	4.30	3.50	5.00	4.80		3.80	3.50						5.00	4.70	4.50	4.00				3.50
16			4.40	4.30	4.20	3.50	5.00	4.50		3.80	3.50	3.20					5.00	4.45	4.50	4.00				3.50
18			4.20	4.10	4.00	3.50	5.00	4.30		3.65	3.50	3.15					5.00	4.30	4.30	3.80	4.00	3.20		3.50
20			4.00	3.90	3.80	3.50	5.00	4.15		3.90	3.50	3.40	3.00				4.80	4.20	4.10	3.65	3.80	3.10		3.50
22			3.80	3.80	3.60	3.00	4.50	3.90		3.80	3.40	3.20	2.90				4.40	4.00	3.90	3.45	3.60	2.95		3.00
24							4.00	3.70		3.65	3.20	3.10	2.80				4.00	3.80	3.75	3.30	3.40	2.80		2.90
26																	3.80	3.40	3.50	3.15	3.20	2.70		2.80
28																								
30																								
32																								
34																								



Unit: t

Continued table 2-3 total rated lifting load for fixed jib

Boom length (m)	37						40						43						
	9.15		12.20		15.25		9.15		12.20		15.25		9.15		12.20		15.25		
	10	30	10	30	10	30	10	30	10	30	10	30	10	30	10	30	10	30	
Jib angle (°)																			
Radius (m)																			
9																			
10																			
11	5.00																		
12	5.00		4.50				5.00									5.00			
13	5.00	4.80	4.50		4.00		5.00		4.50						5.00		4.50		
14	5.00	4.80	4.50		4.00		5.00	4.80	4.50		3.50				5.00		4.50		3.50
15	5.00	4.70	4.50		4.00		5.00	4.80	4.50		3.50				5.00	4.80	4.50		3.50
16	5.00	4.70	4.50	3.80	4.00		5.00	4.50	4.50	4.00	3.50				5.00	4.80	4.50		3.40
18	5.00	4.55	4.50	3.70	3.80	3.20	5.00	4.50	4.30	4.00	3.40	3.20	5.00	4.70	4.70	4.30	3.80	3.30	
20	4.60	4.40	4.15	3.60	3.65	3.10	4.50	4.30	4.15	3.80	3.30	3.15	4.45	4.40	4.15	3.75	3.20	3.20	
22	4.10	4.20	4.00	3.40	3.50	3.00	4.00	4.10	4.00	3.65	3.20	3.05	3.95	4.15	4.00	3.65	3.10	3.10	
24	3.60	3.70	3.70	3.30	3.35	2.90	3.60	3.65	3.50	3.45	3.10	2.95	3.50	3.60	3.50	3.45	3.00	3.00	
26	3.20	3.30	3.30	3.20	3.20	2.80	3.15	3.20	3.10	3.30	2.95	2.85	3.10	3.10	3.05	3.15	2.80	2.90	
28	2.90	2.90	2.90	2.90	3.00	2.75	2.80	2.80	2.80	2.80	2.70	2.75	2.70	2.70	2.70	2.70	2.80	2.70	2.80
30	2.50	2.55	2.60	2.60	2.60	2.65	2.45	2.50	2.40	2.50	2.40	2.50	2.40	2.30	2.40	2.45	2.35	2.50	
32	2.20	2.20	2.30	2.30	2.30	2.40	2.10	2.20	2.10	2.20	2.10	2.25	2.00	2.05	2.00	2.10	2.00	2.20	
34							1.85	1.90	1.80	1.90	1.90	2.00	1.70	1.80	1.70	1.85	1.70	2.00	

1. The lifting load in the table is the rated lifting capacity for the crane set up on firm and level ground, which should not exceed 75% of tipping load.
2. The lifting load in the table is the rated lifting capacity subtracted the weight of slings (main hook block + auxiliary hook block).
3. The counterweight is 16.5t, and the 5t capacity hook block is 0.115t.
4. The crawler track must be extended before lifting operation
5. The radius is the actual working radius for the crane lifting a load.

Notes on Table 2-2, Table 2-3

- 1) The total rated lifting loads shown in the tables are based on the condition that the crane is set on firm and level ground (no risk of sinking) with specified boom length and working radius, ground gradient do not exceed 1%. Never operate the crane beyond the rated load. In case of unfavorable conditions such as soft or unlevel ground, wind, side load, oscillating effect, multi cranes lifting, the total rated lifting loads should be limited or reduced.
- 2) Each total rated load includes the weight of hook block and slings.
- 3) The working radius in above tables is the horizontal distance from vertical line of hook block with a suspended load to centerline of slewing, including the actual value of boom deflection.
- 4) The blank space in above table means the operation under these conditions is not allowed.
- 5) The boom can be used with a single top equipped.
- 6) The max. rated lifting load for single top (including the weight of hook block, slings and wire rope) is 5t, and lifting operation is according to the load if it is less than 5t.
- 7) The max. working radius of single top should not exceed the corresponding value for main boom. The min. one is determined by the boom angle under same working condition.
- 8) Lifting operation is allowed when the wind speed is not more than 9.8 m/s.
- 9) It is not allowed to use main hook block and single top hook block at the same time.
- 10) There are three kinds of hook block with capacity of 55t, 26t and 5t. The 5t capacity hook block is for jib and single top, and the weight of hook block is as the following:

Hook block capacity	55t	26t	5t
Weight of hook block	600kg	280kg	115kg

Table 2-4 relation among boom length, parts of line and rated lifting load

Boom length (m)	13	16	19	22	25	28	31
Parts of line	10	9	8	7	6	5	4
Lifting load (t)	55	48	40	33	28	25	20
Boom length (m)	34	37	40	43	46	49	52
Parts of line	3	3	3	3	2	2	2
Lifting load (t)	17	16.6	12.4	12	11.6	11.3	9.1



2.2.2 Wire rope reeving

Working conditions

- Place the hook block on the ground by lowering the boom.
- Remove the rope guard at the boom head and the rope guard on the hook block. Remove the over-wind cutout device weight from the winch rope as well as hook block.
- Connect boom sections as required length.
- Fix the hook block selected, install the over-wind cutout device weight as well as the rope guard at the boom head and the rope guard on the hook block.
- Reeve the winch rope in the desired number of parts of line, rope socket anchored to boom or to hook block.

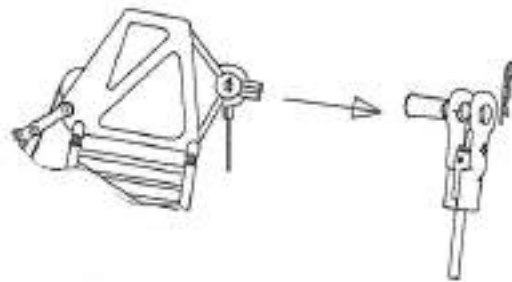

Fig. 2-3a even parts of line



Fig. 2-3b odd parts of line

f. Change parts of line

Note: the mounting position of the over-wind cutout device weight is different according to the number of parts of line.

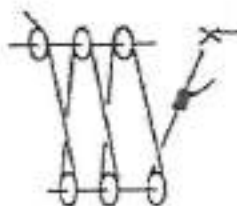

Even

Fig. 2-4a mount the weight on the part of line with the rope socket.

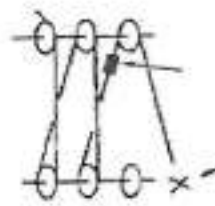

Odd

Fig. 2-4b mount the weight on the part of line that is next to the rope-socketed one.



Rope reeving methods are shown in Fig. 2-5a, Fig. 2-5b and Fig. 2-5c

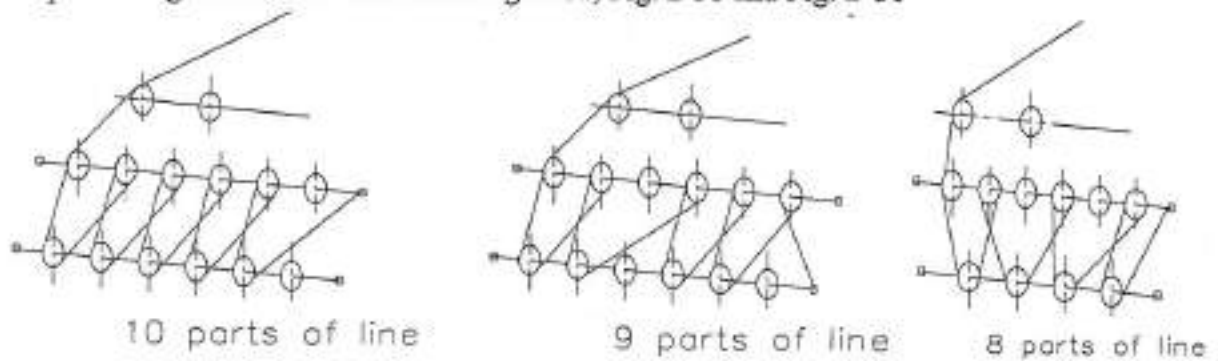

Fig. 2-5a wire rope reeving for 55t capacity hook block

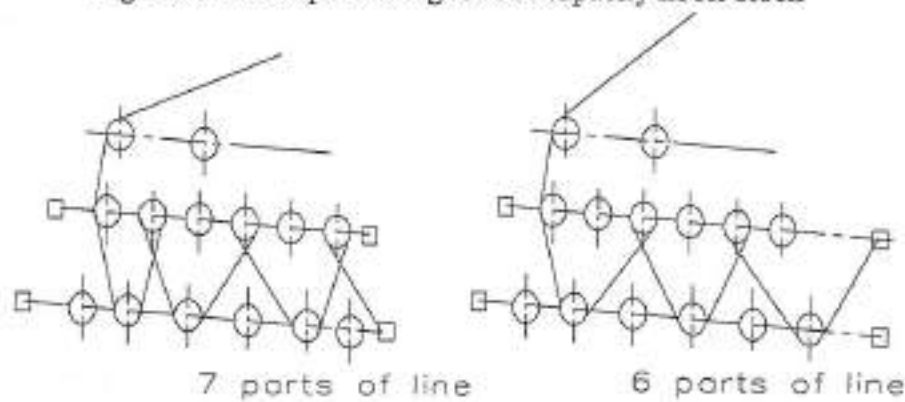

Fig. 2-5b wire rope reeving for 55t capacity hook block

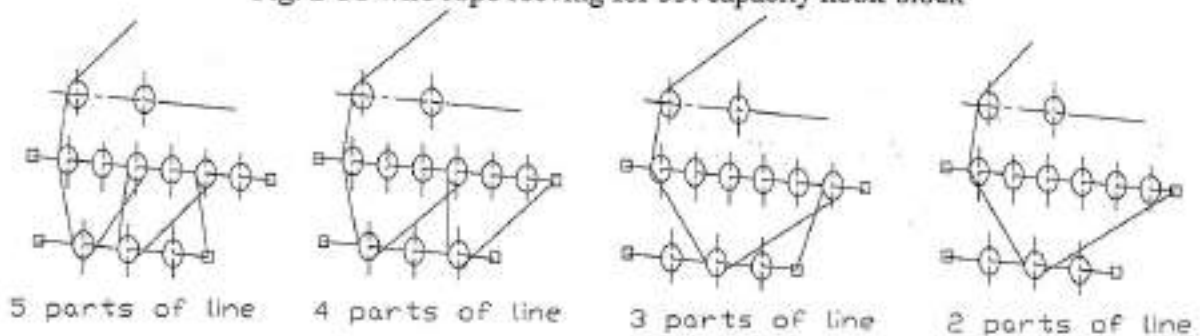

Fig. 2-5c wire rope reeving for 26t capacity hook block

2.2.3 Main parts structure and specifications

(1) Engine model: SC7H175.1G2

Type: in line, 4-stroke, turbocharged, air-cooled.

(2) Slewing ring

Type: single-row roller slewing ring

Model: 013.45.1600.101.04.11F1

(3) Oil pump

Model: variable displacement piston pump A8V107SR

(4) Boom system

a. Boom length: 13m~52m, equipped with single top assy.



b. Fixed jib (operation within the range of 25~43m boom length)

Boom length with fixed jib for tower jib operation: 25~43m

Fixed jib length: 9.15m~15.25m

(5) Operator's cab

Type: all round angle structure, equipped with air conditioner and CD player.

(6) Main systems

Main systems configuration and application refer to Table 2-5.

Table 2-5

System	Parts	Application	Location
Main winch	Motor: A6V107 Speed reducer: QBLK180D(for quick release configuration) QBL260-00 (for common configuration)	For boom operation	At front of turntable slewing center
Auxiliary winch	Motor: A6V107 Speed reducer: QBL260-00	For jib operation	At rear of turntable slewing center
Elevating winch	Motor: A2F107W2Z2 Seed reducer: JQ170.51A-02	For boom elevating	At rear of turntable
Slewing unit	Motor: A2F63W2Z2 Seed reducer: HS160-00	For superstructure slewing	At front of turntable
Travel unit	Motor: A2FE107W70A11 Speed reducer: XBL800-00	For crane travel	Crawler track drive sprocket roller



2.3 Safety devices

2.3.1 Safety devices for boom working condition

The safety devices for boom working condition refer to Fig. 2-6.

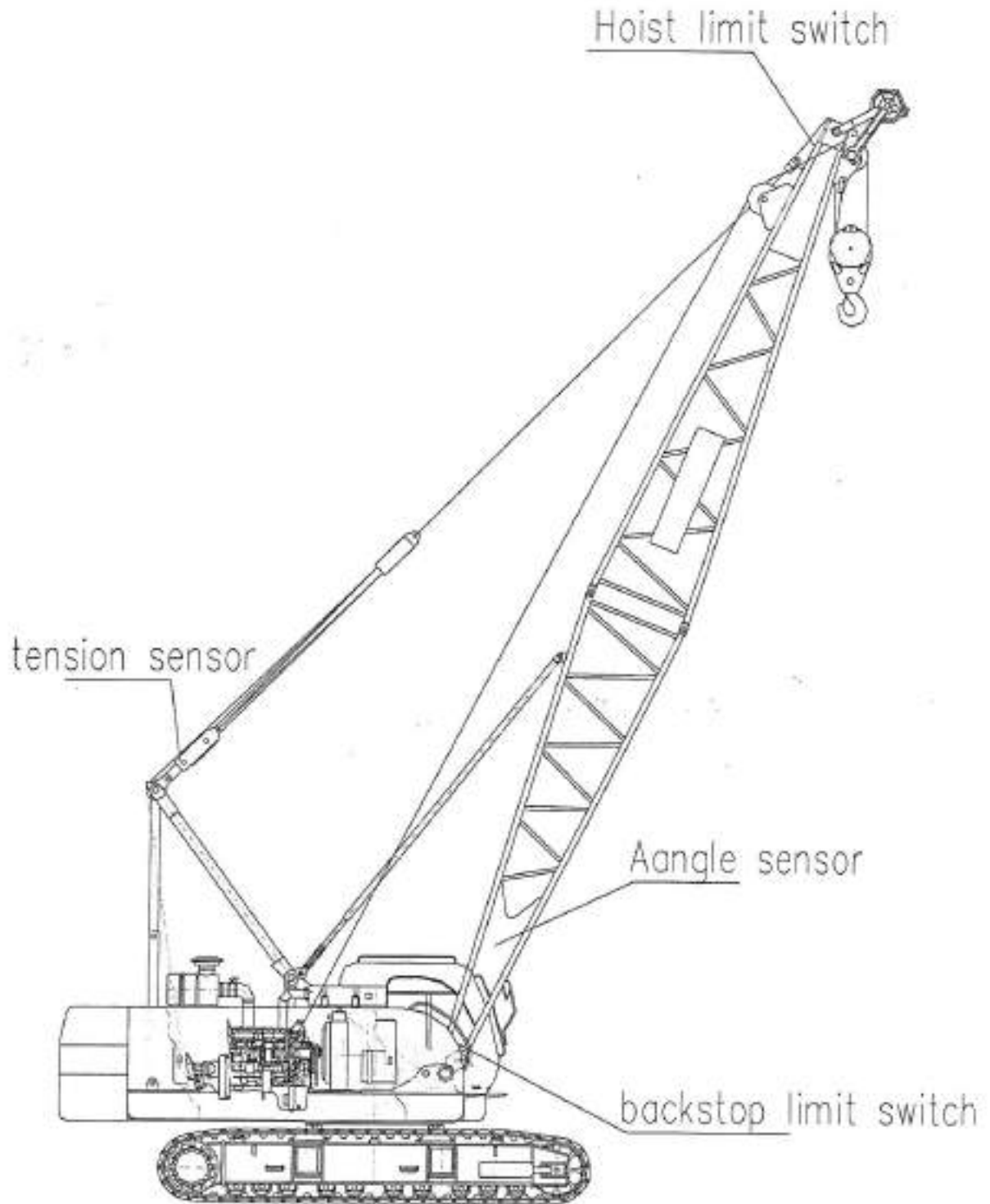

Fig. 2-6 safety devices for main boom



- (1) **Hoist limit switch:** when safe distance between the hook block and sheave block is to be exceeded, the switch will stop the consequent movement of hook block.
- (2) **Tension sensor:** measures tension applied to guy line during lifting operation, and sent signal to controller for calculating load moment.
- (3) **Angle sensor:** measures main boom angle while a load is applied, and sent signal to controller for calculating load moment.
- (4) **Buffer bar backstop switch:** when boom is up to limit angle during elevating operation, the switch will be turned on, consequently movement of elevating up is stopped.
- (5) **Backstop switch:** its function is the same as buffer bar backstop switch.



2.3.2 Safety devices for jib working condition

The safety devices for jib working condition refer to Fig. 2-7.

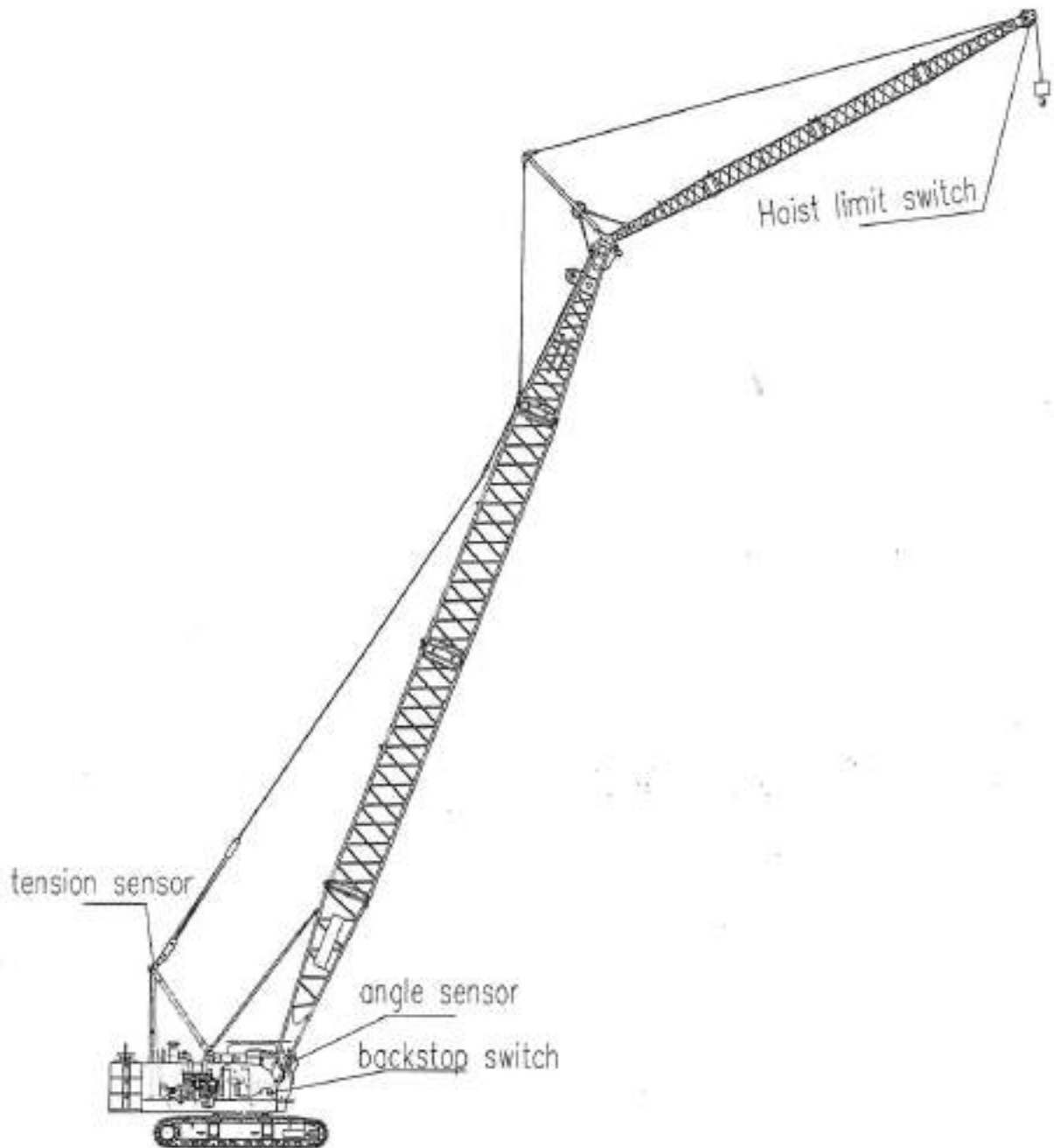

Fig. 2-7 safety devices for jib

Warning: the above safety devices are set to protect property and personnel lives. Inspect them before operation for correct installation and function. Otherwise, operations of lifting load and elevating boom are not allowed. Despite the crawler crane is equipped with various safety devices, the operator should also have the ability to identify the various dangerous conditions, in order to make the correct determination.



Memorandum



III. Crane Assembly and Disassembly

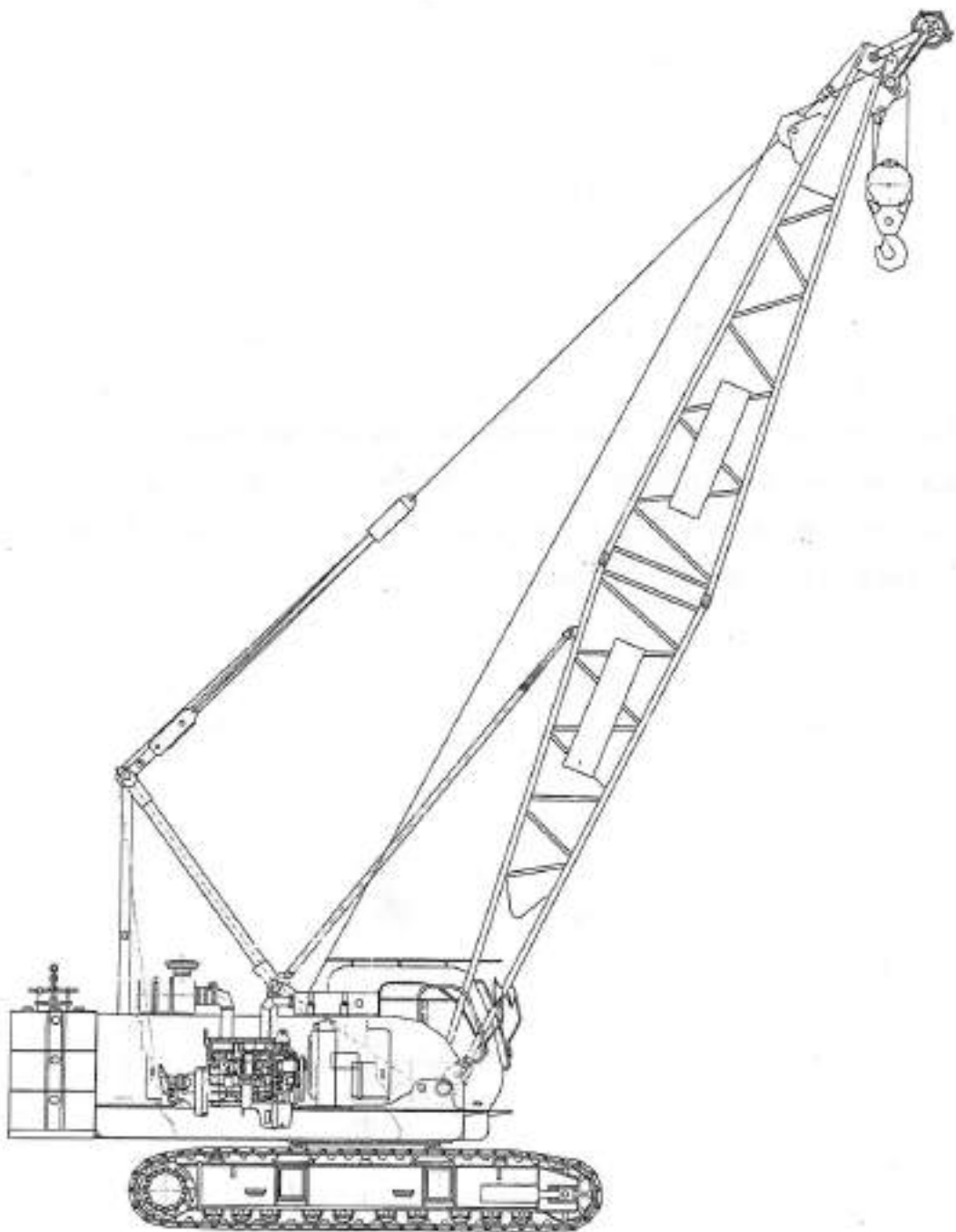



3.1 Basic machine assembly and disassembly

This crane has no function for long distance travel due to its bulky large size, so it is necessary to disassemble the crane for site-transfer and transport, and assemble the crane on site. The parts need to be removed from the machine are: counterweight, boom system(except for boom base), turntable, car-body and mast, winch, elevating gear mounted on turntable to be transported as part of the basic machine(as shown in Fig. 3-1).

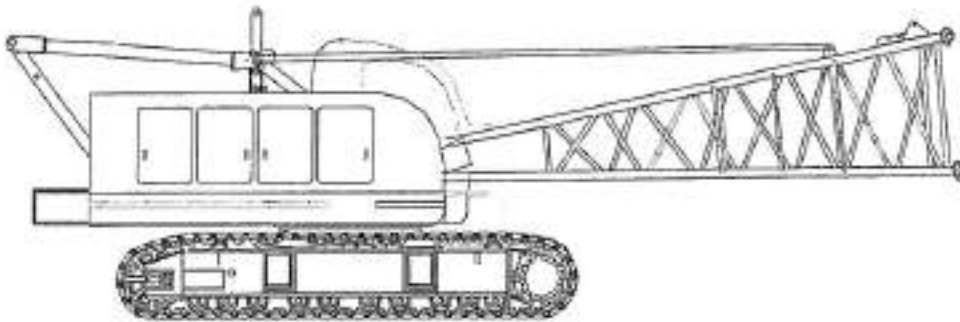

Fig. 3-1 basic machine in transport state

3.2 Notes on operation:

1. **Note:** select flat, firm and open ground surface for crane assembly.
2. **Caution:** use the slings correctly. Do not hook the chain, rope and hook block directly to the chord members and lacing members of the boom. Be sure to use high strength nylon rope or rubber mats.
3. **Danger:** during assembly and disassembly, make sure that there is no person under the boom. When raising or lowering boom with boom length more than 50m, and boom angle to the ground less than 30° , hook block must not be clear off the ground.
4. **Warning:** this machine has large-size and heavy-weight components, the machine assembly/disassembly must be slow and smoothly, the operator needs to have a rational station, with seatbelts, to avoid crushing, extrusion and falling from a high-level and other accidents.
5. **Danger:** in assembly mode, the load moment limiter is shielded, and the machine cannot be stopped by itself when there will be an overload, tipping or cracks in load bearing components, this is very dangerous.
6. **Danger:** during crane assembly and disassembly, the uneven, soft, slippery ground is likely to cause an accident seriously damaged to life and property. The un-stable load or sudden load sliding on the boom threatening accidents.
7. **Note:** in the boom assembly and disassembly, if the boom sections are not directly



placed on the ground, suitable wood blocks should be used under the boom section for leveling. Especially in assembly of fixed jib or elevating jib, the non-leveled boom sections may cause difficult to install fixed jib or elevating jib, and may result in damage to the boom due to local excessive force!

8. Note: when the main chord and web rod have a certain degree of knocks, pits, bending, or deformation, the customers are recommended to replace them in time.
9. Danger: during crane assembly or disassembly, the wrong doings will cause an accident seriously damaged to life and property.
10. Only suitable material can be used as the basis of outrigger pad, and to ensure that the ground is solid, level and no sinking, if this is not observed, there will be an sudden accident!

3.3 Basic machine assembly procedure

1. Pull out the turntable swing lock pin
2. Unload the basic machine
3. Reset the boom backstop buffer bar
4. Adjust the crawler track tension(if necessary)
5. Extend the crawler track
6. Reeve the elevating rope (if elevating sheave block removed)
7. Change the mast from lower position to higher position
8. Install the counterweight
9. Assemble the boom
10. Install the hook block
11. Attach the hoist limit switch

3.3.1 Pull out turntable swing lock pin

As Fig. 3-2, before starting the machine, the swing lock pin in front of the turntable must be pulled out, otherwise the turntable cannot turn around. Method: pick up the swing lock pin handle to disengage the lock from the lock seat, rotate the handle to an angle, to make the tension pin on the pin shaft drop down into the pin bush slot, release the handle to remove the lock between superstructure and undercarriage.

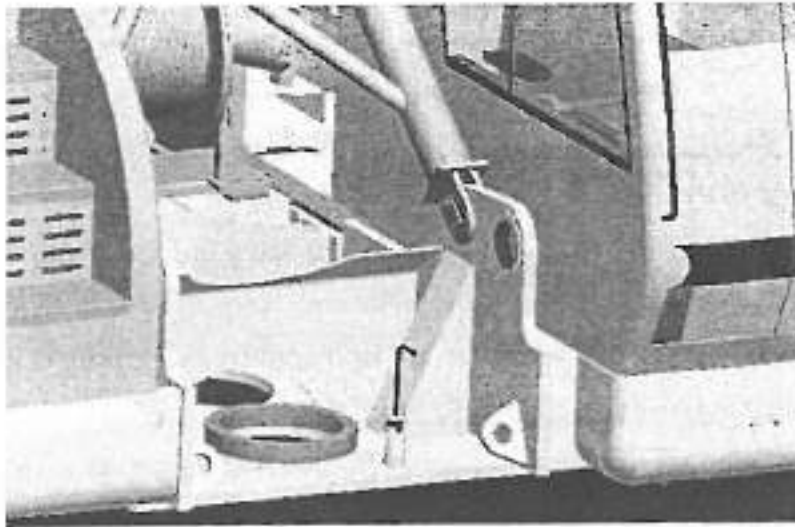

Fig. 3-2 slewing lock pin

3.3.2 Unload the basic machine

The crane basic machine weights approx. 31t.

1. Make sure the work site is level and firm, if necessary, reinforce the ground or place steel plate on the ground.
2. Start the engine and drive the basic machine from the flatbed down to the ground.

3.3.3 Reset boom backstop buffer bar

To prevent the boom backstop buffer bar from deformation during transport, for long distance transport, the backstop buffer bar must be removed from the mast lower pivot, and after retraction fixed at the boom root pivot, (as shown in Fig. 3-1). For operation, the backstop buffer bar must be re-installed on the mast lower pivot (as shown in Fig. 3-3), otherwise it will easily cause overturning and other serious accidents to the boom!

Danger: for operation, the backstop buffer bar must be re-installed on the mast lower pivot (as shown in Fig. 3-3), otherwise it will easily cause overturning and other serious accidents to the boom!

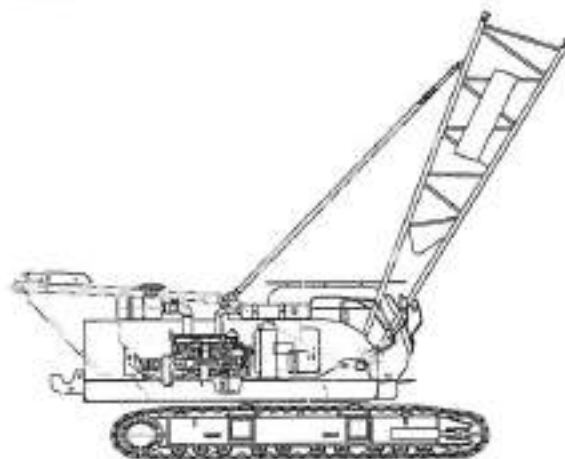

Fig. 3-3 reset boom backstop buffer bar



3.3.4 Adjusting crawler shoes

Keep crawler shoe in appropriate tightness, which will guarantee stable crawler travel, and timely adjust crawler shoes if they are too tight or loose. Clean crawler shoes before adjustment (keeping crawler clean is one of the key daily maintenance items).

The adjustment work shall be carried out on even ground. Move the crane forward a little so that the loos part is on the drive sprocket for easy adjustment.

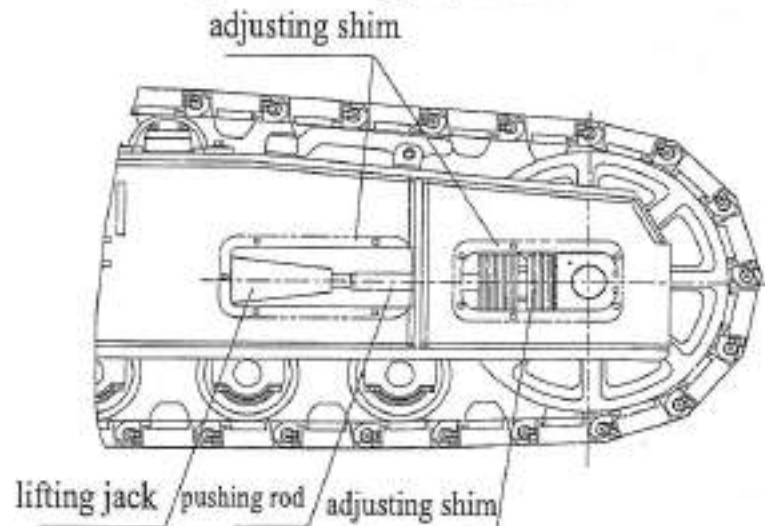

Fig. 3-4 adjust crawler shoes

As shown in Fig. 3-4, the adjustment procedure is as follows:

1. Remove the closing plate and bolt:
2. Use lifting jack to push the pushing rod, and the guide roller slide block is pushed forward, so there is clearance between slide block and adjusting shim, then add or remove the adjusting shims to adjust crawler tightness. Note: this shall be done by at least two operators cooperating with each other. If the stroke of lifting jack is not enough, add adjusting shims between lifting jack and pushing rod to increase the stroke.
3. Retrieve the lifting jack after the crawler shoes are properly adjusted, then attach the closing plate and bolt.

3.3.5 Crawlers extension

- (a) Select a firm and horizontal ground, turn the crane 90° from straight ahead to crawler side.
- (b) Pull out the crawler extend/retract lever. (Fig. 3-5)
- (c) Pull 4 lock pins out of the pinhole C. (Fig. 3-5)
- (d) Push forward the left crawler control lever, the crawlers will be extended. When the guide pin touches the end of the long pin hole, return the left crawler control lever to neutral.
- (e) Insert 4 lock pins into pinhole A to lock the crawlers. At last, push the crawler extend/retract lever forward to "Travel Position."

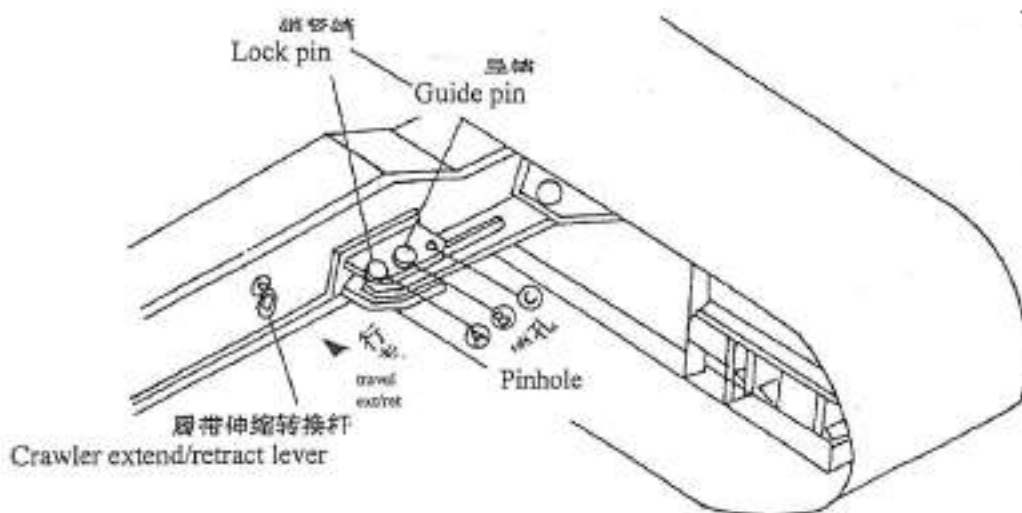

Fig. 3-5 crawler extension

Pin positions

	Guide pin	Lock pin
Crawler retracted	B	C
Crawler in extension/retraction	B	Pull out
Crawler extended	B	A

Notes on crawler extension/retract operation:

- The ground surface for crawler extension must be firm and horizontal, and strengthened if it is soft. First level the crane, and then extend the crawler.
- Crawler extension/retraction only can be performed under the condition of the crane with boom butt and 30° of boom angle, and never perform this operation with a lifted load. With more than 16m boom on the crane, make sure to extend/retract crawler before assembly.
- Clean and grease the crawler sliding parts of the track frame before retracting crawlers.
- The slope plate shall be fixed with bolt after the extension of the track frame, and make sure there is at least 2~3mm clearance between track frame and slope plate. Remove the slope plate before retracting the track frame, and install the plate on the spare strut on track frame and fix with bolts. The removing process: turn the rear of turntable to the side of the track frame, use telescoping cylinder to apply a little pushing force to remove the slope plate.

3.3.6 Reeving of elevating rope

- When the elevating ropes need to be rewound, use 12 parts of line according to the method as shown in Fig. 3-6. Fix the end rope socket with clamp, and bind the rope end with wire to avoid looseness.



2. When operating, it must be careful for elevating rope tension and avoid rope twisting, note that at least 3 turns of wire rope left on elevating winch drum.

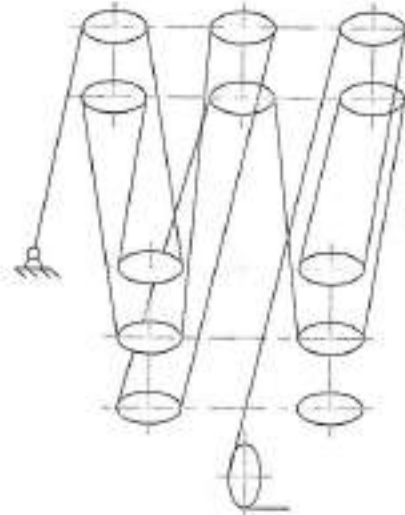

Fig. 3-6 reeving of elevating rope

3.3.7 Change mast from lower to higher

There are lower and higher of two positions for the mast. The higher is for lifting job and the lower is for travel under electric transmission line or for transport with trailer. Never use the lower mast for lifting job.

The method to change mast from higher to lower position:

- a. Let the engine run at low speed;
- b. Lower the boom down on a table;
- c. Loosen the elevating rope slowly, pull out pin (A);(see Fig. 3-7)
- d. Loosen the elevating rope further, the mast will lower down slowly by taking (C) as center.
- e. Align the lower hole (A) and the upper hole (B), and insert the pin pulled out from (A). Reverse the procedures for changing mast from lower to higher position.
- f. The method to change mast from lower to higher position is done with the reverse order.

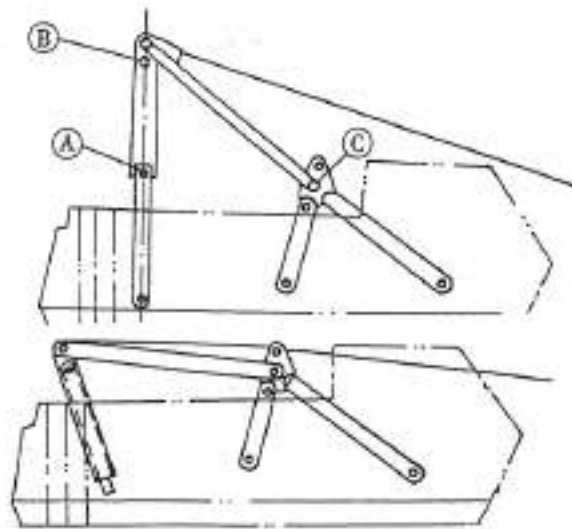

Fig. 3-7 mast height change

3.3.8 Counterweight installation

The counterweight is total 16.1t, consists of 8 parts, with 1 tray, 1 case and 6 blocks, the tray and blocks each weight about 2.2t, the case dead weight 0.6t, can be stored with not more than 0.1t items. The counterweight is distributed on both sides of the tray, and the case placed in the middle of the tray, as shown in Fig. 3-8.

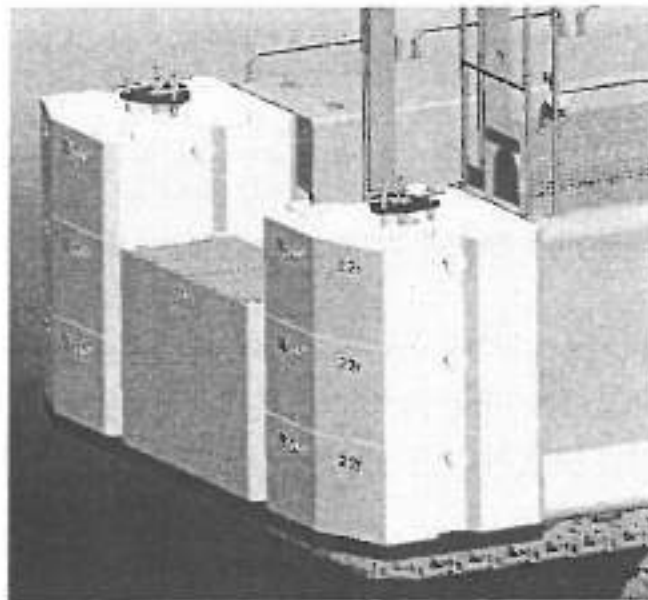

Fig. 3-8 counterweight installation

The installation procedure is as the following:

1. Make sure the work site is level and firm, if necessary, reinforce the ground or place steel plate on the ground.
2. Use assisting crane to lift base counterweight and put it on the turntable tail.
3. Put case onto counterweight tray, and fix it with bolt.



4. Put intermediate counterweight on base counterweight, then connect the two slabs of counterweight by long bolt.
5. Put top counterweight on intermediate counterweight, then connect the two slabs of counterweight by short bolt.
6. Disassembly procedure is in reverse order.

Caution: when lifting counterweight on the left and right sides, pay attention to keep the symmetry to prevent overturning. Do not increase or decrease the number of counterweight, slowly operate the counterweight when the counterweight tray moves to the dead point, and the operator does not stand under the tray.

3.3.9 Boom assembly and disassembly

3.3.9.1 Main boom composition

The main boom length is from 13m~52m, the max. lifting load is 55t (number of parts of line is 10). The main boom combination consists of one boom base, one 3m boom insert, three 6m boom inserts, two 9m boom inserts and one boom top, so as to compose 14 kinds of boom length such as 13m, 16m, 19m, 22m, 25m, 28m, 31m, 34m, 37m, 40m, 43m, 46m, 49m and 52m are available.

The boom and guy lines combination see Table 3-1.



Table 3-1 boom and guy lines combination

Boom length (m)	Boom combinations	Guy line length (m)	Guy line arrangement (m)
13	Boom base + boom top	6.2	A
16	Boom base + 3m boom insert + boom top	9.2	A+B
19	Boom base + 6m boom insert + boom top	12.2	A+C
22	Boom base + 9m boom insert + boom top	15.2	A+D
25	Boom base + 3m insert + 9m insert + boom top	18.2	A+B+D
28	Boom base + 6m insert + 9m insert + boom top	21.2	A+C+D
31	Boom base + 2×9m insert + boom top	24.2	A+2×D
34	Boom base + 3m insert + 2×9m insert + boom top	27.2	A+B+2×D
37	Boom base + 6m insert + 2×9m insert + boom top	30.2	A+C+2×D
40	Boom base + 3×6m insert + 9m insert + boom top	33.2	A+3×C+D
43	Boom base + 2×6m insert + 2×9m insert + boom top	36.2	A+2×C+2×D
46	Boom base + 3m insert + 2×6m insert + 2×9m insert + boom top	39.2	A+B+2×C+2×D
49	Boom base + 3×6m insert + 2×9m insert + boom top	42.2	A+3×C+2×D
52	Boom base + 3m insert + 3×6m insert + 2×9m insert + boom top	45.2	A+B+3×C+2×D

Notes: A=6.2m, B=3m, C=6m, D=9m; a 0.38m transition section should be installed over luffing pulley block in each boom length working mode, both left and right, 2 sections totally.

Note: the position and order of boom insert must be strictly according to the boom assembly scheme, the different boom combination can achieve the same total boom length, despite the same total boom length, but the lifting load chart is different.

3.3.9.2 Boom assembly

With help of an assist crane, the main boom assembly procedure is as the following:

- 1) Prepare boom inserts according to required boom length, and prepare guy cables and pin shafts according to Table 4-1.
- 2) Connect all the boom sections and guy cables arranged along boom, then drive back the basic machine to the front of boom, adjust the basic machine to align the pivot hole on boom base with the pin shaft hole on boom insert and secure with pin, then connect the required guy cables.
- 3) Connect guy cables as shown in the figure below:

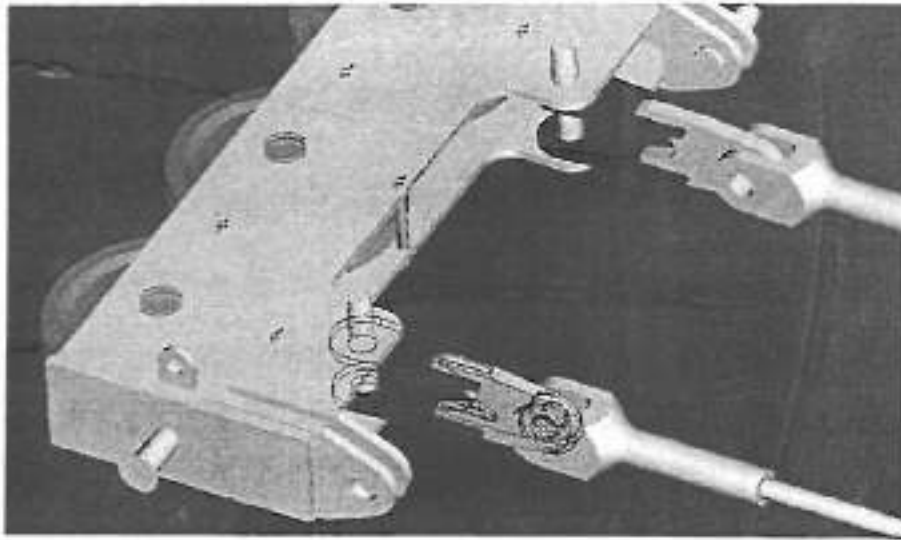

Fig. 3-9 luffing guy cable assembly

- 4) Install boom buffering bar.
- 5) Select hook block and the parts of line for wire rope according to boom length, reeve hoisting steel wires, and then connect electric cable and install the weight of hoist limit switch, etc..
- 6) After counterweight installation, operate the elevating lever slowly to raise the boom.
- 7) Disassembly procedure is in reverse order.

Notes: during disassembly, elevating pulley block touches the tip guiding plate on the boom during lowering down, elevating pulley block moves towards boom head under the affection of self-weight and guiding plate, thus the boom guy line become loose, this make it easy to assemble and disassemble pulley block and guy joint; fix pulley block and boom butt with eye plate on boom butt. As in figure below:

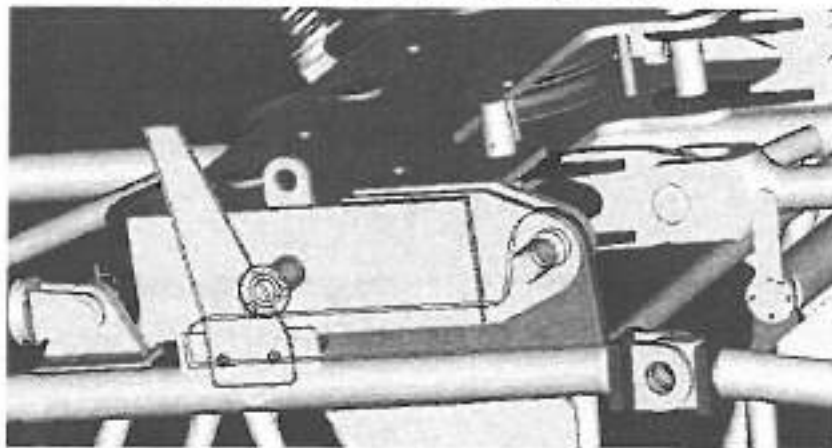

Fig. 3-10 luffing pulley block assembly

3.3.9.3 Fixed jib assembly

Fixed jib length is from 9.15~15.25m, and can be operated within the range of boom length 25~43m.



1) Basic boom and guy lines combination

Main boom consists of boom base, 3m boom insert, 6m boom insert, 9m boom insert and boom top. When attached with fixed jib, boom length is from 25~43m, each 3m is increased or decreased length. The arrangement of boom sections and guy lines refer to main boom descriptions.

2) Fixed jib and front guy lines combination

Fixed jib consists of one jib base (3.05m), one jib top (3.05m), and three 3.05m jib inserts. The jib inserts can be combined according to required jib length. The fixed jib length is from 9.15~15.25m, and each 3.05m is incremental length. The arrangement of jib sections (from jib butt to jib top) and jib front guy lines refer to Table 3-2.

Table 3-2 fixed jib and front guy lines combination

Jib length (m)	Jib combination	Front guy line (m)
9.15	3.05m jib base + 3.05m jib insert + 3.05m jib top	C+D
12.2	3.05m jib base + 2×3.05m jib insert + 3.05m jib top	C+D+D
15.25	3.05m jib base + 3×3.05m jib insert + 3.05m jib top	C+D+D+D

3) Fixed jib rear guy lines

Arrange fixed jib rear guy lines according to fixed jib offset angle and Table 3-3.

Table 3-3

Fixed jib offset angle (°)	Rear guy lines arrangement (m)
10	B
30	A+B

Note: Length: A=1750; B=13260; C=13500; D=5690.

(4) Arrangement diagrams of two kinds of fixed jib and six kinds of guy lines

a. Jib offset angle is 30°

(1) Jib length is 9.15m



Guy line length between boom and strut

$$A+B=1.75+13.26=15.01\text{m}$$

Guy line length between jib and strut

$$C+D=13.5+5.69=19.19\text{m}$$



(2) Jib length is 12.2m

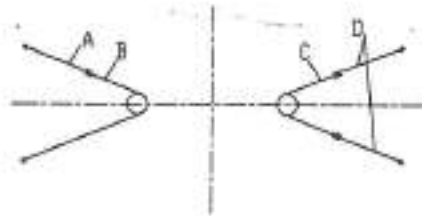

Guy line length between boom and strut

$$A+B=1.75+13.26=15.01\text{m}$$

Guy line length between jib and strut

$$C+D+D=13.5+5.69 \times 2=24.88\text{m}$$

(3) Jib length is 15.25m

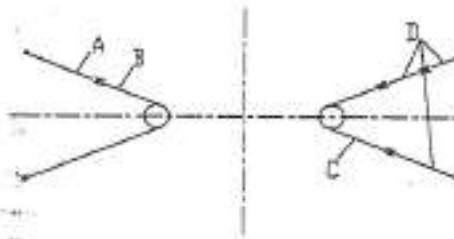

Guy line length between boom and strut

$$A+B=1.75+13.26=15.01\text{m}$$

Guy line length between jib and strut

$$C+D+D+D=13.5+5.69 \times 3=30.57\text{m}$$

b. Jib offset angle is 10°

(1) Guy line length between boom and strut is only one kind, that is B, guy line length is 13.26m.

(2) Guy line length between jib and strut is the same as three kinds in item a.

3.3.9.4 Assembly of fixed jib

The process of fixed jib assembly is the same as that of boom.

3.3.10 Hook block assembly

Choose suitable hook block and parts of line according to working condition requirement, and attach hook block to boom head according to the notes on Section 2.2.2.

3.3.11 Attach hoist limit switch

The hoist limit switch can prevent the hook block from contacting the boom head, as shown in Fig. 3-11). One end of hoist limit switch is fixed on boom head, the other end, with ring, hang in the air. When install hook block, the last part of line rope shall go through this ring, the min. safety distance L is more than 3m.

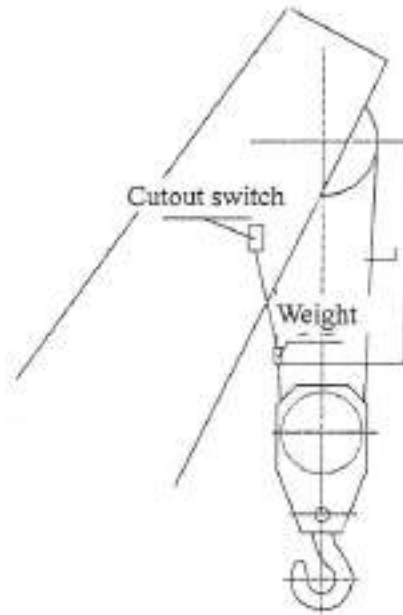

Fig. 3-11 hoist limit switch

3.4 Basic machine disassembly procedure

The basic machine disassembly procedure is in reverse order to the basic machine assembly procedure.



Memorandum



IV. Crane Operation

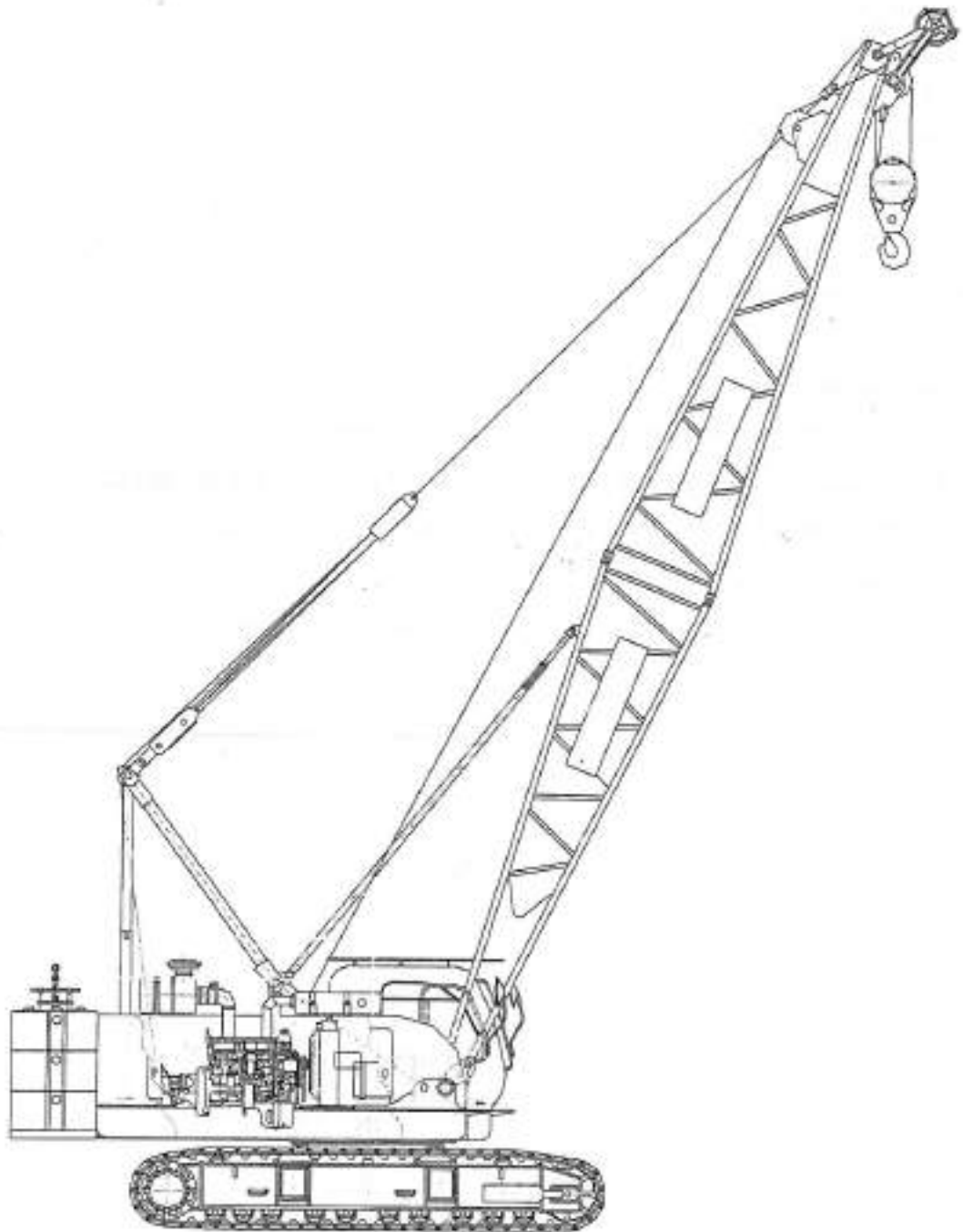



4.1 Electric system

The crane electric system is powered by DC 24V, single line with negative ground, use the principle of switch-relay as basic control. The system consists of engine control, safety control, LMI control and common function control. The whole machine control features advanced technology and high-level intelligent.

(1) Engine control

a. Start the engine

Turn on the power main switch located on the lower side of left armrest first, and then insert the starting key into the starter switch (refer to Fig. 4-5), turn it clockwise to position I to turn on the electric control system for the machine, then turn the key to position II to start the engine. The each starting time can't exceed 15 seconds and the interval for each engine starting is not less than 30 seconds. If it is very cold in winter, the engine needs to be warmed up under 0°C, turn the key to position I and wait for about 30 seconds after pressing preheating switch (see the preheating indicator lamp goes off), then the engine will be started, otherwise it is difficult to start the engine.

b. Stop the engine

1. Press and hold the engine stop switch to stop the engine.
2. Press the emergency stop switch on left armrest panel to stop the engine.
3. Turn the starting key to reverse gear position to stop the engine.

c. Preheat the engine

1. After starting, let the engine run at idle speed for 5~10 minutes when water temperature reached 60°C, in winter or cold area, the preheating time should be doubled.
2. For the engine with electronic preheating controller, turn the starting key, while press the engine preheating switch, when the coolant temperature is higher than the set temperature, the preheating controller does not work, and the engine can be directly started; when the coolant temperature detected lower than the set temperature, the preheating relay automatically starts and connects with low temperature preheating controller, and while preheating indicator lamp lights up, after about 30 seconds, the preheating indicator lamp becomes flashing to end preheating, then the engine can be started.

(2) Safety control

- a. Load moment indicator (LMI), see *Automatic LMI Operation Manual*;
- b. Counter (rope-end limiter): when there are only three to five turns of wire rope left on the drum, the rope-end limiter automatically activates to stop hook lowering.
- c. Indicator lamps: low oil pressure indicator lamp, high water temperature indicator lamp, and etc.



(3) Cab electrical system (introduction to control components)

The controls are located at the right front in operator's cab and on the left and right armrest control boxes, details refer to Fig.4-1.

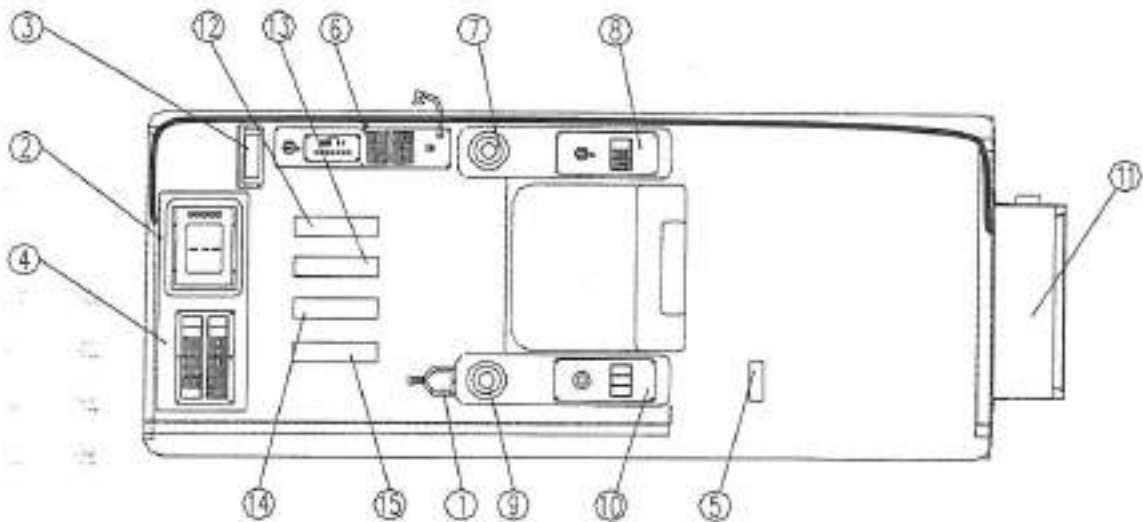

Fig. 4-1 cab layout diagram

- | | | |
|---------------------------------------|------------------------------|-----------------------------------|
| 1. Main power switch | 2. LMI display | 3. Monitor |
| 4. Front control panel assy. | 5. CD player | 6. Side control panel |
| 7. Main winch/elevating control lever | 8. Right armrest panel | 9. Aux. winch/swing control lever |
| 10. Left control panel assy. | 11. Electric control box | 12. Accelerator pedal |
| 13. Right travel pedal(lever) | 14. Left travel pedal(lever) | 15. Swing brake pedal |

a. Monitor:

Refer to *Colored Display Operation Instructions*.



b. Front control panel (see Fig. 4-3)

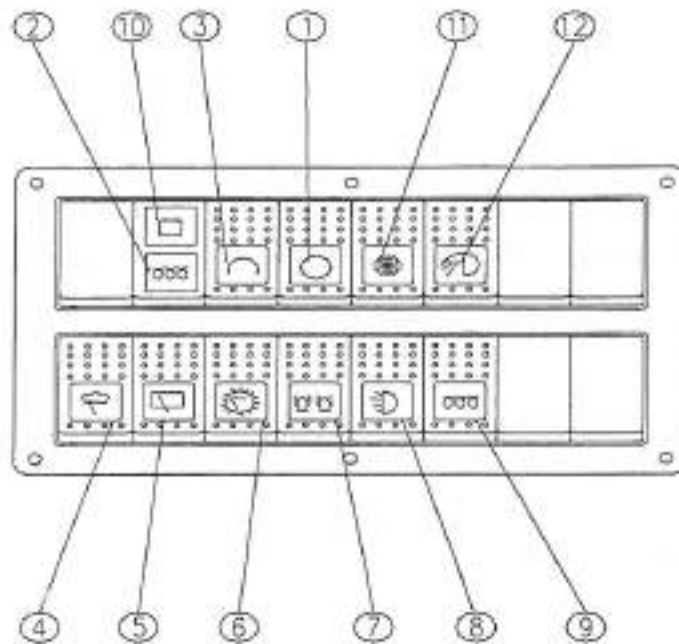

Fig. 4-3 front control switches

- | | |
|---------------------------------------|-----------------------------------|
| 1. Free-swing switch | 2. Engine preheat indicator lamp |
| 3. Swing brake switch | 4. Front windshield wiper switch |
| 5. Roof window wiper switch | 6. Background lamp switch |
| 7. Boom head warning lamp switch | 8. Front illumination lamp switch |
| 9. Engine preheating switch | 10. Battery charge indicator lamp |
| 11. Hydraulic oil radiator fan switch | 12. Working lamp switch |

- **Free-swing switch:** press the switch the turntable can carry out free-swing operation.
- **Engine preheating indicator lamp:** indicate engine preheating, refer to the engine preheating operation.
- **Swing brake switch:** press the switch, the turntable can carry out swing operation.
- **Front windshield wiper switch:** control front windshield wiper.
- **Background lamp switch:** press the switch to open background lamps for night operation.
- **Boom head warning lamp switch:** press the switch to turn on the warning lamp on boom head.
- **Front illumination lamp switch:** turn on/off illumination lamp in front of turntable.
- **Engine preheating switch:** start the preheating function for the engine, refer to the engine preheating operation.
- **Battery charge indicator lamp:** it is used to indicate the generator working condition, the generator is used to charge the battery, it is off to charge, and it is on not to charge.
- **Hydraulic oil radiator fan switch:** when hydraulic oil temperature is high, press the switch



to start the radiator fan to cool the hydraulic oil.

- **Working lamp switch:** it is used to illuminate the switches and instrument in the cab.

c. Side control panel (see Fig.4-4)

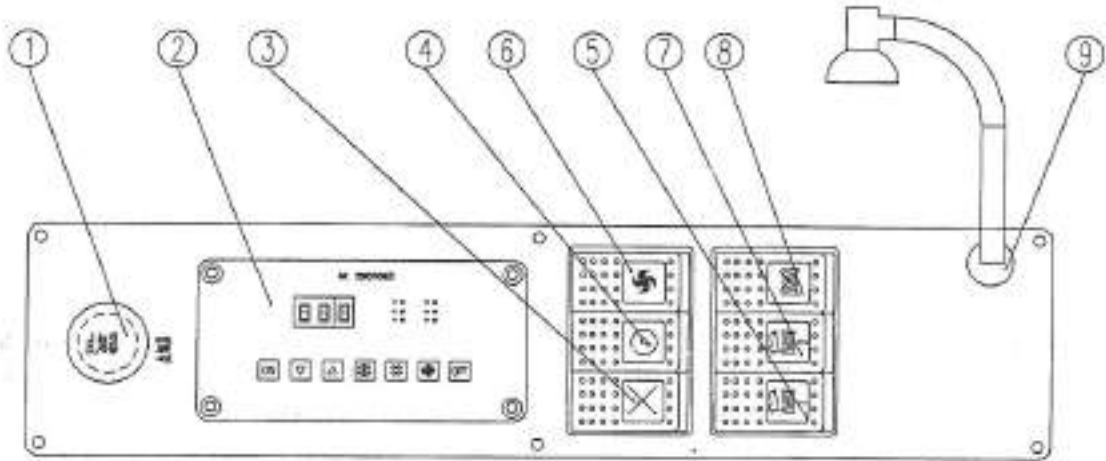

Fig.4-4 side control panel

- | | |
|---|-------------------------------|
| 1. Cigarette lighter | 2. Air conditioner controller |
| 3. Bypass switch | 4. System pressure switch |
| 5. Main winch in-high-speed switch | 6. Cab fan switch |
| 7. Auxiliary winch in-high-speed switch | 8. Ratchet lock switch |
| 9. Working lamp | |

- **Cigarette lighter:** supply a power interface for electrical apparatus.
- **Air conditioner controller:** refers to air conditioner instruction for detailed operation.
- **Bypass switch:** the switch can be pressed only when the crane is lifting a load more than 2% of the total rated lifting capacity under overload condition; and in the crane assembly process, press the switch for testing of some unloading movements. Bypass switch cannot be used at will, and improper use may have a danger of overall tipping.
- **System pressure switch:** press the switch to build up hydraulic pressure for operation.
- **Main winch in-high-speed switch:** press the switch to start the main winch in high speed work, do not press the switch if do not use it.
- **Cab fan switch:** press the switch the fan in driver's cab begins work for cooling the cab.
- **Auxiliary winch in-high-speed switch:** press the switch to start the auxiliary winch in high speed work, do not press the switch if do not use it.
- **Ratchet lock switch:** press the switch to open the ratchet pawl.
- **Working lamp switch:** press the switch to turn on the illumination lamps in the cab.



d. Right control panel (see Fig.4-5)

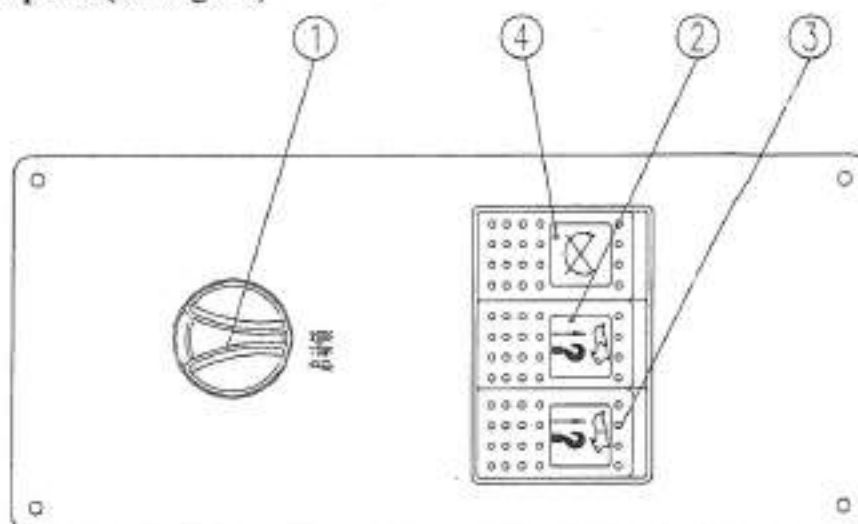

Fig. 4-5 right control panel

1. Key switch 2. Auxiliary winch quick-release switch (option)
 3. Main winch quick-release switch (option) 4. Engine stop switch

- **Key switch:** insert the starting key into the starter switch, turn it clockwise to position I to turn on the whole vehicle control system, then turn the key to position II to start the engine.
- **Auxiliary winch speed-up switch (optional):** press the switch to increase operation speed for auxiliary winch hoist up/down. Note: it is only equipped for conventional model.
- **Main winch speed-up switch (optional):** press the switch to increase operation speed for main winch hoist up/down. Note: it is only equipped for conventional model.
- **Engine stop switch:** press the switch to stop the engine, and release the switch after engine stop.

Note: The engine stop switch is only actuated before the key switch has no power, and engine also can be stopped by the key switch reverse gear, but it is recommended to stop the engine by operating the engine stop switch.

e. Left control panel

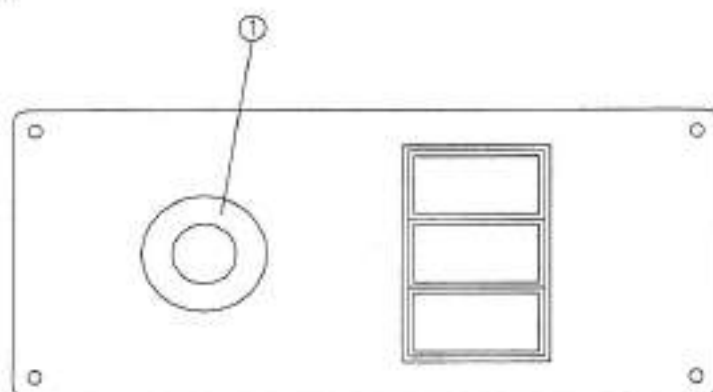

1. Emergency stop switch



- **Emergency stop switch:** press the switch to stop the engine.

4.2 Hydraulic system

QUY55 crawler crane main hydraulic system is total power variable displacement pump-control system (including main winch, auxiliary winch, elevating gear and travel gear), and slewing gear is driven independently by gear pump. Pilot control circuit is supplied by 16ml/r pinion pump. The combination of pilot control pressure unloading solenoid valve and safety monitor system improve the safety for the whole machine and efficiently prevent the wrong operation. All the crane main movements are performed by advanced hydraulic proportional control technology, operated and controlled by operator through the control of the moving direction and displacement of hydraulic controlled joystick lever, with step-less speed regulation and good fine motion. The brake for each mechanism is all constant-closed type, through the braking valve to control the brake for opening and closing. Undercarriage track frame telescopic cylinder shares one direction change valve with left travel unit, and a mechanical pull lever can be operated for track frame extension and retraction.

Main and auxiliary hoist winches use variable displacement hydraulic motor, and can be selected by switch for high-speed mode, improved working efficiency.

Balance valve uses the imported product, with stable work and reliable safety.

Motor oil refilling is considered in the system design, efficiently prevent motor from stall.

Hydraulic oil brand:

Ambient temperature	Hydraulic oil brand
above -5℃	L-HM46 hydraulic oil
above -10℃~ -5℃	L-HM32 hydraulic oil
above -30℃~ -10℃	L-HV22 hydraulic oil
above -60℃~ -30℃	No. 10 aviation hydraulic oil

4.3 Start and stop engine

Refer to *Engine Operation Instruction*.

Before starting the engine, confirm that all control levers and switches are in neutral positions, and then insert the key into starting switch and turn clockwise to gear I. After power is turned on, check parameter shown on display and indicator lamps for normal conditions, if everything is normal, start the engine. Refer to Section 4.1 for starting methods.

Cautions on operation of starting engine:

- Never use the key switch successively. The starting time for each attempt should be less than 15 seconds and the interval between two attempts is 30 seconds.
- Properly preheat the engine after starting. After water temperature reaching 60℃, allow the engine to idle for 5~10 minutes. In winter or low ambient temperature



conditions the time of warming up should be doubled.

- c. Refer to the engine operation manual for correct readings of water temperature gauge, oil pressure gauge and ammeter when the engine is running.
- d. Never cut out power when the engine is running.
- e. When anti-freeze coolant hasn't been used in winter, drain off the cooling water completely to prevent tank being damaged after finishing operation.
- f. Allow the engine to idle about 5 minutes before shutting it off after a full load operation.

Cautions on operation of shutting down engine:

- a. Return all levers to neutral, and engage pawls and lock slewing brake.
- b. Allow the engine idle for some minutes to cool down it.
- c. Refill the fuel tank, and drain out the water in the tank regularly.
- d. Never open the radiator cover when the water temperature in the radiator is too high to prevent scald.
- e. Never add cold water into extremely hot engine water tank.
- f. In cold weather, coolant should be added in the cooling water. Otherwise, drain out the cooling water in the radiator after shutting off the engine.

4.4 Control Levers

There is one lever (Fig. 4-6) respectively on driver's seat left and right armrest for controlling crane operations.

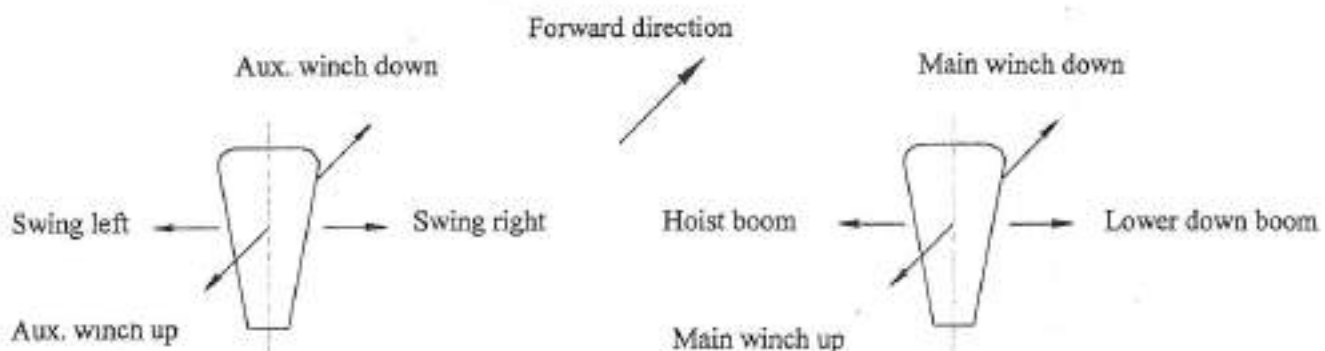

Fig. 4-6 control levers

4.5 Winch operation

4.5.1 Main winch operation: pull backwards the right lever shown in Fig. 4-6 to hoist main winch, push it forwards to lower the main winch.

4.5.2 Auxiliary winch operation: pull backwards the left lever shown in Fig.4-6 to hoist auxiliary winch, push it forward to lower the auxiliary winch.

4.5.3 Main winch high-speed operation: press the switch No.3 in Fig. 4-5.



4.5.4 Auxiliary winch high-speed operation: press the switch No.2 in Fig. 4-5.

4.5.5 Main winch fast-release: press the switch and step on pedal valve, the hook block will lower down in fast speed; release the valve, brake the fast release operation.(only for QUY55 with fast release configuration)

Cautions:

- a. Do not use the winch with high-speed operation when the crane is lifting a heavy load, which may cause the dangers such as engine shutdown and other conditions.
- b. Do not operate the main winch and the auxiliary winch at the same time. When lifting a load, due to the deformed ground, do not lift a load at once, lift a load slightly off the ground, after everything is confirmed normal, then lift up the load.
- c. Lift a load only in vertical way, do not drag a load not clear off the ground, and avoid side loading.
- d. In a heavy load condition, the engine has an idle speed or a low speed, at this time the joystick lever slight opening will cause winch sliding, so avoid the nonstandard operation to prevent the machine from damage.
- e. Do not fast release the main hook block with load(only for cranes with fast release configuration)!
- f. The fast release operation procedure is(only for cranes with fast release configuration):

Press the fast release switch——step on foot valve for fast release——release the valve to brake the fast release operation——release the fast release switch

4.6 Luffing operation

4.6.1 Press the ratchet lock switch (No. 4 in Fig. 4-5) to release elevating winch drum ratchet lock.

4.6.2 Move the right lever in Fig. 4-6 to the left to raise the boom, move it to the right to lower the boom.

Caution:

- a. When elevating boom, the drum ratchet must be released.
- b. When elevating down, pay attention to the wire rope on the drum, do not release all the rope on the drum. If do not elevating for a long time, use the ratchet to lock the drum.

4.7 Slewing operation

4.7.1 Pull out slewing lock pin (in front of turntable) to release the lock for turntable.

4.7.2 Move the left lever in Fig. 4-6 to the left, the turntable slews left; move it to the right the turntable slews right.

**Caution:**

- a. Insert slewing lock pin if do not use the machine for a long time after engine shutdown.
- b. Carry out slewing operation slowly, abrupt brake during operation is not allowed, so as to avoid a serious condition.

4.8 Travel operation

4.8.1 Push forwards the left travel lever (No. 14 in Fig. 4-1) to drive the left crawler forwards, pull it backwards to drive the left crawler backwards.

4.8.2 Push forwards the right travel lever (No. 13 in Fig. 4-1) to drive the right crawler forwards, pull it backwards to drive the right crawler backwards.

Cautions:

- a. Position travel motor on the rear of the machine during long distance travel.
- b. Travel with a load suspended is allowed only under main boom working conditions, but the boom must be over front of the crane, and the load must be less than 70% of the total rated lifting load. Travel with a suspended load should be slowly, the gradient less than 1%, and the height above the ground less than 250mm.

4.9 Crawler telescopic cylinder operation

4.9.1 Pull upwards crawler telescopic switch-over bar (Fig. 3-3).

4.9.2 Pull forwards the left travel lever (Fig. 4-1).

Caution:

- a. The crawler must be in extended state for the crane lifting operation, otherwise the crane is not in stable condition and overturning will happen.
- b. Please refer to section 3.1 in this operation manual.

4.10 Indication plates**(1) Nameplate**

Nameplate is fixed on the outside of cab door. There are crane name, model, rated lifting capacity, date and manufacturer on it.

(2) Other indication plates

- a. Warning sign: many kinds of warning signs are fixed on crane boom and counterweight.
- b. Indication sign: there are operation indication signs on the left and right sides of the chair, and hydraulic oil tank indication sign on the top of oil tank, etc.



Memorandum

1. 1. 1. 100
2. 1. 1. 100
3. 1. 1. 100





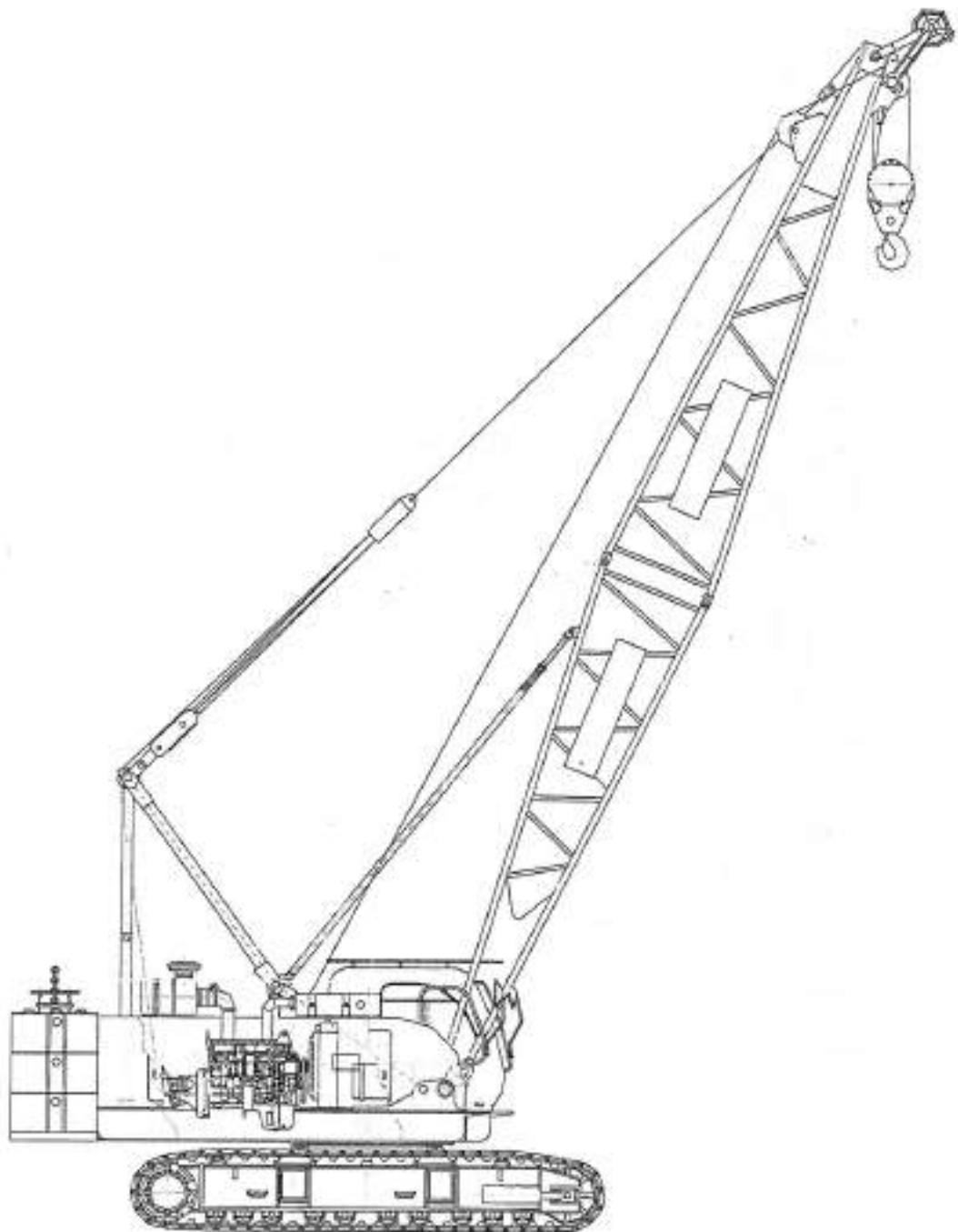



V. General Cautions in Operation







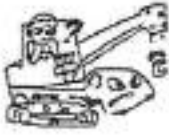



5.1 General cautions





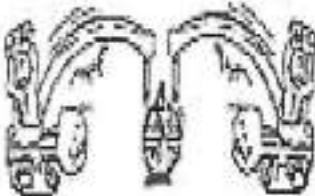

Cautions in operating the crane are summarized here. Before starting to operate your crane, carefully read and thoroughly understand them for safe operation.

No.	Illustrations	Cautions	Remark
1.		Observe the section of "Starting and Stopping Engine" items in the instruction manual.	Preoperational checks
2.		Check the hydraulic oil level with the crane in preparation stage, to make sure that the specified quantity is in the tank.	
3.		Check all the members for defects and abnormalities. If abnormalities occur, remove immediately.	
4.		Do not check and repair the crane when it is in lifting operation.	
5.		After starting the engine, run it at a low speed to warm it up sufficiently.	
6.		Move the control levers and switches without load to check for correct crane functions. If any crane operation is faulty, repair immediately.	
7.		Perform the specified preoperational checks of the controller (Refer to the controller instructions.)	









No.	Illustrations	Cautions	Remark
8.		<p>Check all other safety devices for proper function. (e.g. pressure gauge, etc.)</p>	Preoperational checks
9.		<p>Turn on the power switch and starter switch in operator's cab before starting to operate the crane.</p>	
10.		<p>The crane must be stopped on solid and level ground.</p>	During crane operation
11.		<p>Do not lift loads in excess of the rated lifting capacity. Do not overload the crane. Avoid side-loading or dragging loads on the ground. Do not try to take a load pressed by other loads or lift a load buried or stuck on the ground due to freezing.</p>	
12.		<p>In general, lifting a load with two or more cranes at the same time is not permitted. If a load must be lifted with two or more cranes, carry out the lifting operation with straight wire ropes, synchronous movements of cranes and on condition that load on each crane must not exceed 80% of its rated lifting capacity, and a senior engineer should be present for guide.</p>	
13.		<p>The boom deflects under loads and the working radius increases. When calculating the total rated lifting load, take this into consideration.</p>	

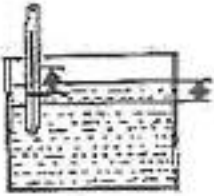









No.	Illustrations	Cautions	Remark
14.		Operate the crane slowly while you are familiarizing yourself with its operation. Do not abrupt start or stop the crane, especially for lifting a load with a larger radius and a higher height.	During crane operation
15.		Don not increase the counterweight or decrease the parts of line of wire rope at will.	
16.		Do not look to the side when operating the crane. Operators must take signals only from designated signalmen. Operators must respond to emergency stop signal whenever and whoever sent.	
17.		Check safety conditions around the crane during operation. Operator should not leave the machine with a load suspended unattended.	
18.		Bo not stand under the boom or within the slewing radius.	
19.		When operator will leave the cab, place the load on the ground, move all the levers to natural positions, press the ratchet switch to lock the elevating winch ratchet.	
20.		During lifting operation, if the engine stops, move the joystick lever to natural position, lock the elevating winch ratchet.	



No.	Illustrations	Cautions	Remark
21.		<p>Pay attention to the hydraulic oil temperature, and stop operation when the temperature rises above 80°C. Note that the amount of oil in the cylinders, tanks, etc. changes when the temperature changes.</p>	During crane operation
22.		<p>Take note of weather report:</p> <ol style="list-style-type: none"> 1) Where the wind velocity is over 9.8m/sec. do not operate the crane. 2) If it is very windy or thundering, stop operating the crane and stow the boom. 	
23.		<p>Avoid side loading or dragging loads on the ground.</p>	
24.		<p>Do not travel with a rated lifting load, do not travel with a lifting load on a soft ground, do not travel with a load on gradient 5%, and do not travel with a load with a jib attached. Travel with a load 70% of total rated lifting load must be:</p> <ol style="list-style-type: none"> a. Solid ground with 5% of gradient b. Load is clear off the ground within 0.25m. c. Boom is over front of crane travel 	
25.		<p>Lifting operation near high voltage power line, the crane must be kept a certain distance from the power line.</p>	
26.		<p>Do not near cliff or soft road shoulder, if necessary, a signal man is needed to guide the crane operation.</p>	







During crane operation





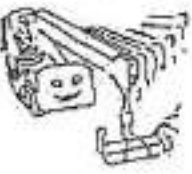



No.	Illustrations	Cautions	Remark
27.		Do not abruptly move the winch control lever.	
28.		During hoisting, lift the load off the ground 250mm, hold down for 10 minutes and check brake, and ascertain safety before further hoisting the load. Do not lift a load off the ground by raising the boom or extending the boom.	
29.		Reeve the winch rope in a proper number of parts of line according to the load to be lifted in order to improve working speed and enlarge wire rope life.	
30.		If the winch rope twines and the hook block rotates, fully untwine the rope before lifting loads	
31.		Do not lower the boom excessively even if no load to prevent crane tipping, especially with longer boom length. Perform operation of boom over front of the crane.	
32.		When lowering the hook block, leave at least 3 turns of the winch rope on the winch drum.	
33.		The mast has two kinds of height, for lifting work, the mast must be at higher height.	
34.		Slowly operate the boom for lowering, when connecting elevating rope with boom lower part, do not lower boom head on the ground.	

Winch operation

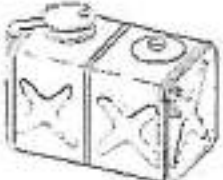

No.	Illustrations	Cautions	Remark
35.		Do not abruptly move the elevating control lever.	Boom elevating
36.		Before swinging the boom, make sure that area in the swing path is clear of personnel and obstructions.	Boom swinging
37.		While the SWING FREE/LOCK select switch is in FREE, take care to prevent the boom from drifting under tilt, wind pressure, or inertia.	
38.		Do not abruptly move the swing control lever. Carry out operation smoothly and slowly.	
39.		Keep the swing brake applied when the boom is not swung.	
40.		Do not adjust the hydraulic components.	
41.		Pay a special attention to the abnormal sound or the heat in the hydraulic system.	



No.	Illustrations	Cautions	Remark
42.		Once every month and every year, periodically inspect the crane	Maintenance and servicing
43.		Clean or replace the hydraulic oil at regular intervals to keep it always clean.	
44.		Replace the gear oil and other lubricants regularly.	
45.		Grease all the specified greasing points, and other rotating and sliding members regularly.	
46.		Replace the filter element regularly.	
47.		Before each operation, check the oil levels of the hydraulic oil, gear oil, and other lubricating oils for correct quantity, and refill as necessary.	
48.		Keep all parts properly adjusted. Keep them free from damage, loose mounting, etc.	



✓ Rope end

Check the pin shaft, clamp and connector, etc. at rope end to ensure the tightness for the connector and wire rope.

h. The working speed is slowly and smooth, otherwise the rope on the drum will loosen.



5.2 Cautions in winch rope use

- a. When winding a new wire rope on the winch drum, take care not to twist the rope.
- b. After installing a new wire rope on the winch drum, repeat hoist up and down a load of 10 % rated load several times.
- c. Inspection and discard wire rope according to GB/T5972-2009 *Cranes- Wire Rope-Care, maintenance, installation and discard*.
- d. When the winch rope becomes twined, correct it as follows:

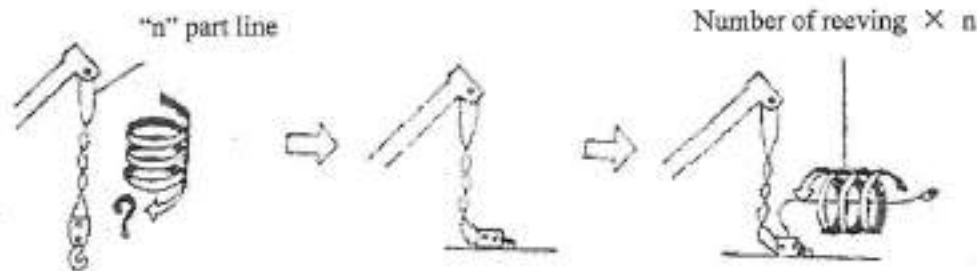

- (1) Check the direction of the twining and count the number of twining turns.
- (2) Lower the hook block to the ground. (If the hook block cannot be hoisted down, lower the boom.)
- (3) Disconnect the rope socket from the hook block (or boom head). Turn the rope end in the twine direction "n" times the number of twines as counted in step 1) before attaching the rope socket to the hook block (or boom head).

Note: do not turn the rope five reeving (or more) at a time. n: part line

- (4) Raise the boom to the maximum angle. Repeat hoisting up and down the hook block several times.
- (5) Repeat the procedure above until no twining remains.

Warning: if twining still remains after the above measures, replace the rope with a new one.

- e. Wind the first layer of wire rope on the winch drum uniformly and with proper tension applied to it.
- f. It is recommended that the hook end and the drum end of the winch rope should be periodically reversed or cut off 0.5m from drum end to extend the rope life.
- g. Check the winch rope every working day for damage and deformation. Especially pay attention to fixing position of the winch rope. Periodically inspect the following:
 - ✓ Common position
 - Beginnings and ends of the winch rope.
 - Rope sections passing through sheaves.



Memorandum

Plus sign



VI. Transport

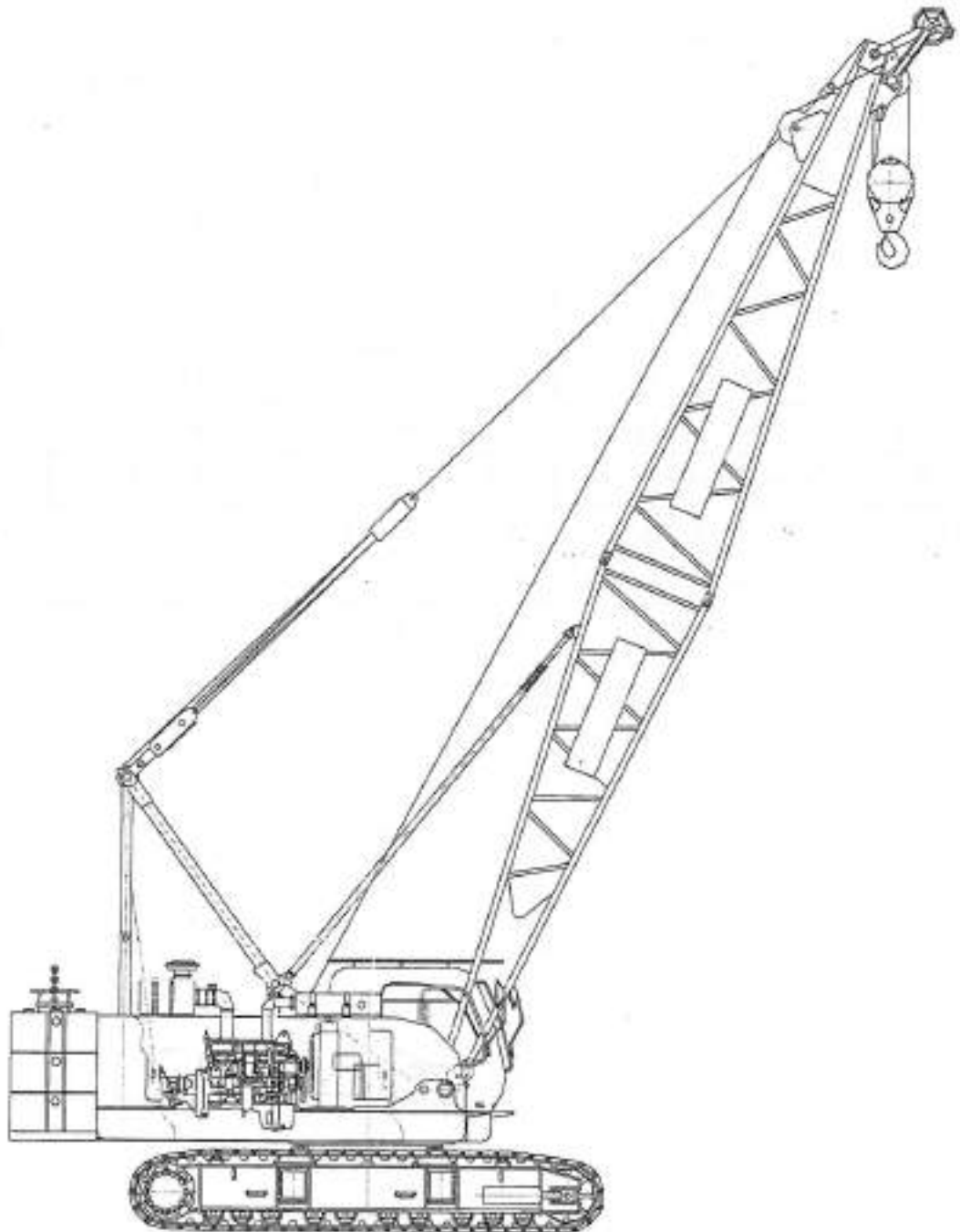

6.1 Short distance site transfer

For a short distance transfer, the crane can travel by itself with main boom of 13m attached. Travel on a flat asphalt road as possible as you can, and at low speed if travel on a slope. Keep the propel motor at the rear of the crane if it is to travel for a long distance and never let the engine run at a high speed for a long time.

6.2 Long distance site transfer

For a long distance transfer, the crane must be transported on a trailer. After loading the crane on a trailer, engage the swing lock pin and put wood block, bind the crane with wire rope to ensure stability while the trailer is traveling.

The whole vehicle weighs 53t, transport weight and size of each unit is as the follows:

Table 6-1 Transport weight and size for each crane unit (total weight 53t)

SAP No.	Parts Name	Weight (kg)	Length (mm)	Width (mm)	Height (mm)	Qty.	Remarks
170200361	Basic machine	31	11.5	3.4	3.4	1	With boom base, mast, with 50L fuel oil
170200256	Counterweight tray	2.2	3.36	1	0.58	1	Counter-weight
170600992	Left counterweight	2.2	0.95	1	0.5	3	
170600993	Right counterweight	2.2	0.95	1	0.5	3	
170200257	Mid counterweight	0.7	1.36	0.56	0.93	1	
170100102	9m boom insert	0.683	9	1.4	1.4	2	Boom
170100112	6m boom insert	0.46	6	1.4	1.4	3	
170100115	3m boom insert	0.262	3	1.4	1.4	1	
170100118	Boom top	0.74	6.5	1.4	1.4	1	
170100016	Single top	0.1	0.11	0.65	0.5	1	Single top
170101506	55t cap. hook block	0.6	1.56	0.51	0.55	1	Hook block
170101508	26t cap. hook block	0.28	1.2	0.29	0.48	1	
170101507	5t cap. hook block	0.115	0.5	0.3	0.3	1	
170100595	Jib top	0.103	3.35	0.605	0.54	1	Jib
170100655	Jib base	0.124	3.165	0.605	0.54	1	
170100648	Jib insert	0.083	3.12	0.605	0.54	3	
170100682	Jib strut	0.145	3.1	0.61	0.45	1	
	Guy cable, pin shaft	1					



6.3 Transport planning:

- 1: Basic machine 31t (spare tools and spare parts can be put in cab, but wire rope box, adjusting shim and track shoe cannot be put in the cab.)
 2: 1 spare tools box (size 1600×1600×900), tools list see Table 6-2. approx. 1t
 3: 55T hook block, 26T hook block 0.88t
 Note: insert support wood before and after track frame to prevent slide during transportation.

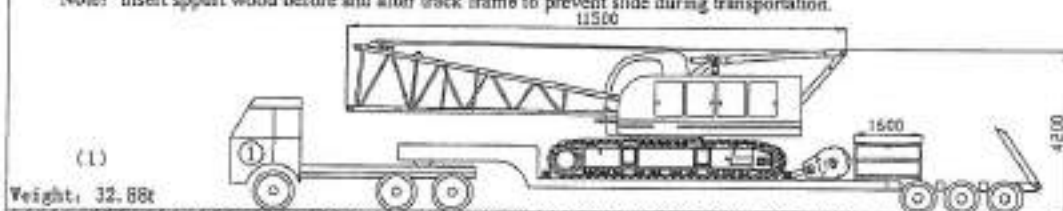

- 1: Counterweight slab (1 counterweight tray, 3 left counterweight slabs, 3 right counterweight slabs, 1 middle counterweight slab. arrange according to the diagram) 16.1t
 2: Boom assembly (2 9m boom inserts, 1 3m boom insert, 1 6m boom insert, 1 boom top, 1 boom single top and 1 gentry ladder) 1 group 2.928t
 3: Boom and jib assembly (2 6m boom inserts, 1 jib butt and strut, 1 jib top, 3 jib inserts) 1 group 1.547t
 Note: boom on the lower layer shall be put with the lug end downward, see Detail 1. and support wood size shall be higher than strut, the size of support wood in the diagram is 150×150. the length is determined by the width of boom.

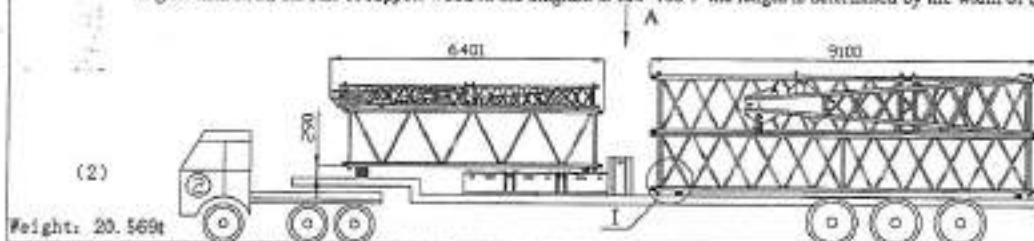

Detail 1



counterweight slab arrangement

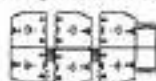

A view

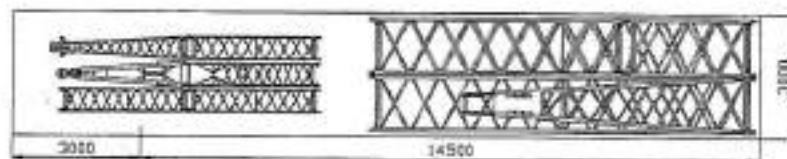

Vehicle information

Low platform trailer with gooseneck L: 15000 mm W:3200 mm Ground clearance: 825mm Rated load (T) 35

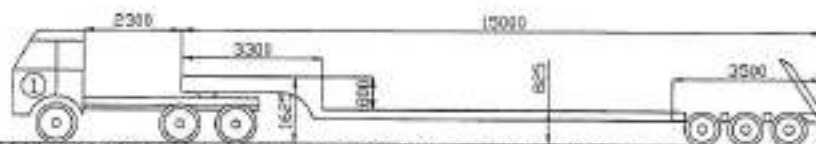

17.5m platform trailer L: 17500 mm W:3000 mm Ground clearance: 1200mm Rated load (T) 30

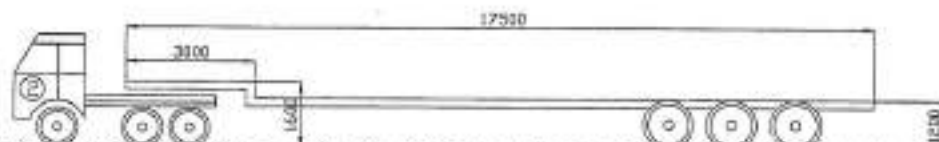



Table 6-2 small parts such as pin shaft, guy cable and etc. are all packed in one supplied tools kit for transport, and the packing list is as the follows:

No.	SAP Code	Parts name	Qty.	Remarks
1	170101563	Clip II ($\phi 6$)	38	Boom and boom guy cable
2	170101604	Shaft ($\phi 50-165$)	28	
3	170100193	Roller assy.	2	
4	170200530	Guy cable A(L=6.2m)	2	
5	170200531	Guy cable B(L= 3m)	2	
6	170200532	Guy cable C(L= 6m)	6	
7	170200533	Guy cable D(L= 9m)	4	
8	170101775	Shaft ($\phi 50-185$)	14	
9	170101775	Pin shaft ($\phi 30-140$)	8	Jib and jib guy cable
10	170101558	Spring clip $\phi 7$	22	
11	170102071	Wire rope A(L=1.75m)	1	
12	170102072	Wire rope B(L=13.26m)	1	
13	170102069	Wire rope C(L=13.5m)	1	
14	170102070	Wire rope D(L=5.69m)	3	
16	170100631	Connection plate	12	
17	170102063	Pin shaft ($\phi 35-89$)	14	
18	170101561	Spring clip	4	Mast ladder assy.
19	170101783	Tube	1	
20	170101784	Tube	1	
21	170600795	Wedge assy.(incl. wedge, sleeve, pin shaft)	2	Hoist wire rope wedge assy. And rope clip
22	801300046	Rope clip	2	
23	803600746	Hoist limit switch	1	Boom position limit
24	803600850	Hoist limit switch	1	Jib position limit
25	170101507	5t capacity hook block	1	Supplied spare parts
26	170101537	Crawler track shoe	1	
27	170101423	Adjusting shim	6	



Table 6-3 counterweight small parts such as pin shaft, bolt and etc. are all packed in supplied mid-counterweight tools kit for transport, and the packing list is as the follows:

No.	SAP Code	Parts name	Qty.	Remarks
1	800305546	T (8) Chain, L=1.7m	2	
2	170200258	Pin shaft (φ55-230)	2	
3	172102301	Clip	2	
4	170601149	Plate	2	
5	170601150	Screw bar	6	
6	170601153	Bar	6	
7	170601154	Retainer plate	2	
8	805000043	BoltM10×30	4	Installed on No.4
9	805300014	Washer 10	4	
10	805000471	BoltM24×130	2	Transport with counterweight tray
11	805000520	BoltM24×100	2	
12	805200117	Nut M24	4	
13	805000164	BoltM16×55	4	
14	805300011	Washer 16	4	
15	805300111	Washer 16	4	

This transport table is suitable for full loading and only for reference.



VII. Customer Acceptance Items

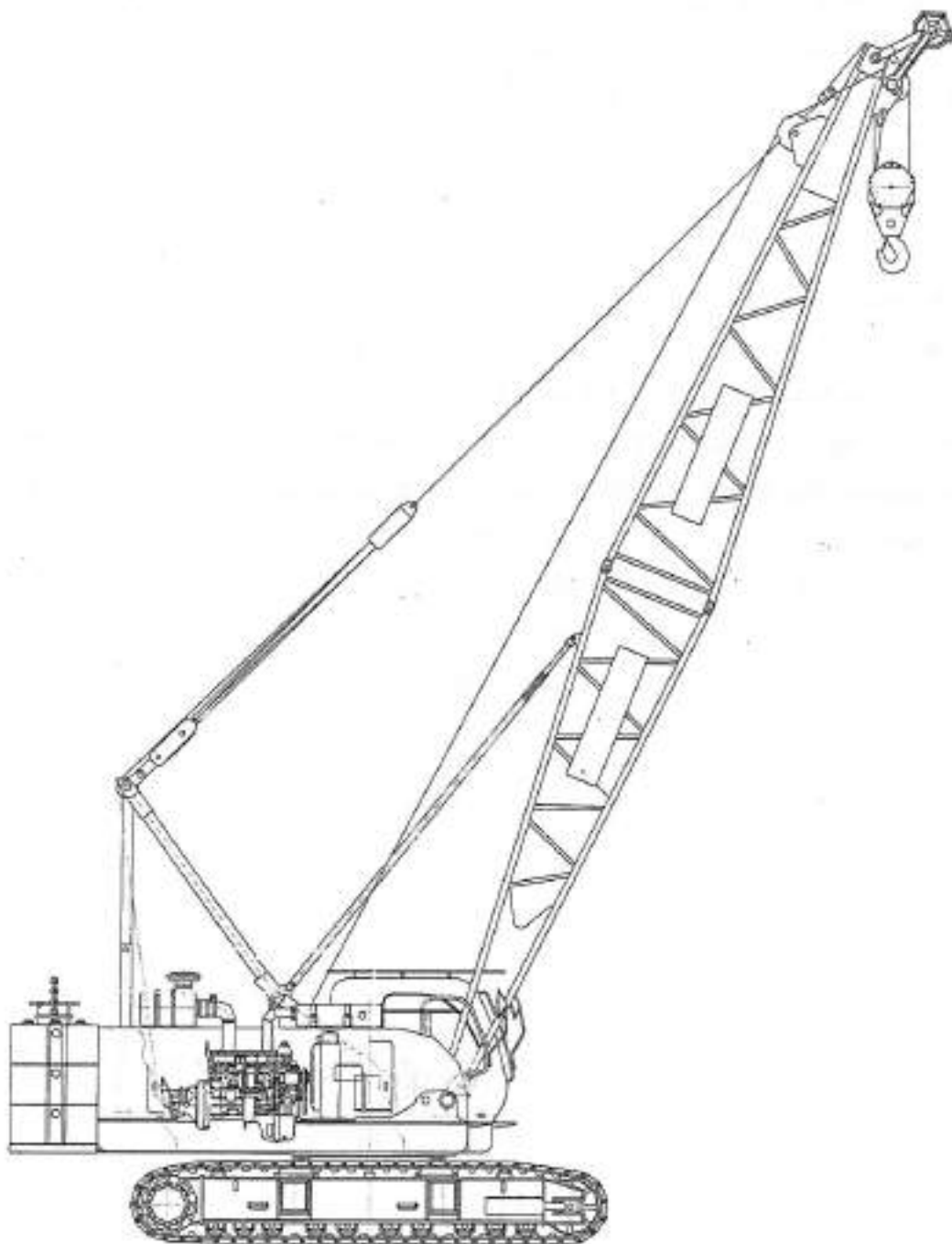



QY55 Customer Acceptance Items

After receive our products, please check the crane performance according to the following items to see whether all the crane performance meet our design requirements.

1. Requirements for site condition and ambient temperature

- (1) Ambient temperature: $-20\sim 40^{\circ}\text{C}$
- (2) Wind speed: 6.3m/s (scale 4)
- (3) Working ground: firm and level, with gradient not more than 1%.

2. Inspection items with no load

- (1) Max. single line speed of wire rope at 4th layer: 121m/min
- (2) Max. swing speed for basic boom working condition: 1.5r/min
- (3) Max. travel speed for basic boom working condition: 1.3km/h

Note: site condition and ambient temperature may influence slewing speed and travel speed.

3. Inspection method

Lift a load of 5t (including weight of hook block and riggings) with single parts of line within the working radius specified in the lifting performance table with an arbitrary boom length under main boom working condition; or lift a load of 10t (including weight of hook block and riggings) with double parts of line within the working radius specified in the lifting performance table with an arbitrary boom length under main boom working condition.

Requirements: stable hoisting and lowering, reliable brake.

If possible, the following inspection items may be added:

Lift a load of 55t (including weight of hook block and riggings) with boom length 13m at working radius 3.7m.

中 国 中 国

XCMG, CONSTRUCTION MACHINERY CO. LTD., BUILDING MACHINERY CO.
XUZHOU CONSTRUCTION MACHINERY GROUP CO., LTD., CHINA

Add: No.19 Taoshan Road, Xuzhou Economic Development Zone, Jiangsu, China

Tel: +86-(0)516-87892526

Fax: +86-(0)516-87892527

Post Code: 221000

Website: <http://www.xcmg.com/>

E-mail: xgjlddkf@163.com

Service Tel: +86-(0)516-87892088

Service Fax: +86-(0)516-87892506

The 1st Edition: April, 2011

